



VX

8617.351



www.rittal.com

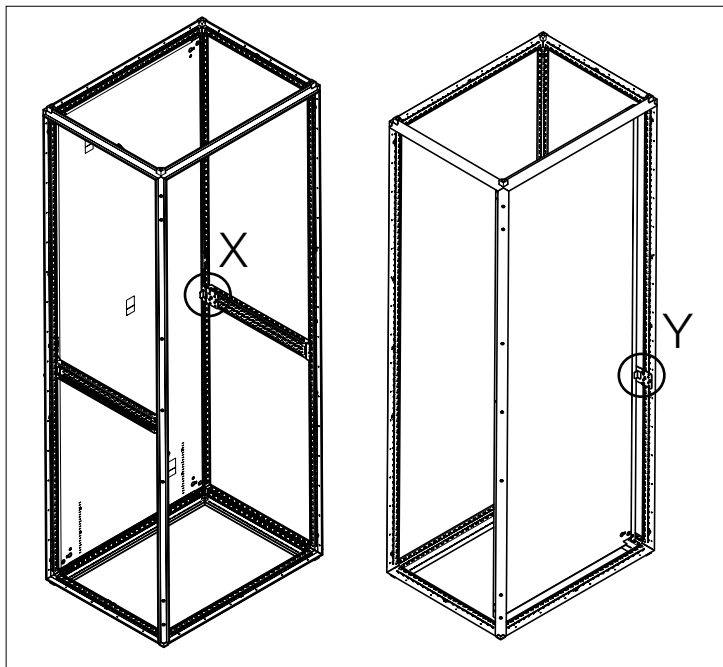

Dok.-Nr. / No of doc.: D-0000-00001298-00
Versandbeutel-Nr. / No. of accessory bag: 372570

Ident.-Nr. / Part No.: 339792
Lieferanten-Nr. / No. of supplier:

Z +/- 25

X

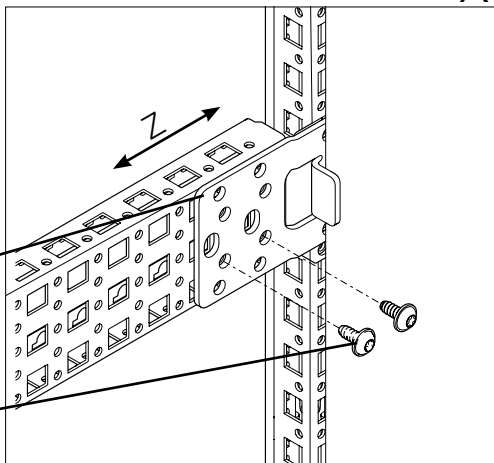

10 x

20 x 5,5x13

- 50

Y

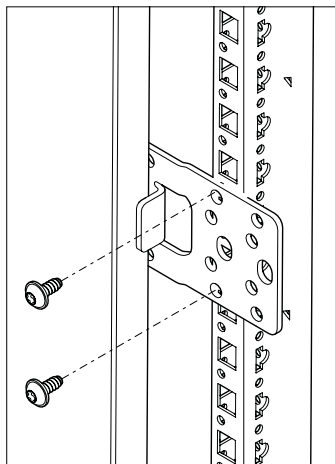

- 75

Y

