



Paulmann

# IP20



Paulmann Licht GmbH  
Quezinger Feld 2  
31832 Springe  
Germany



www.paulmann.com

Art.-Nr.: 999.94



PSEA 06/23

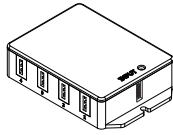

1x

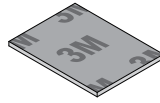

1x



incl.

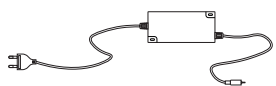
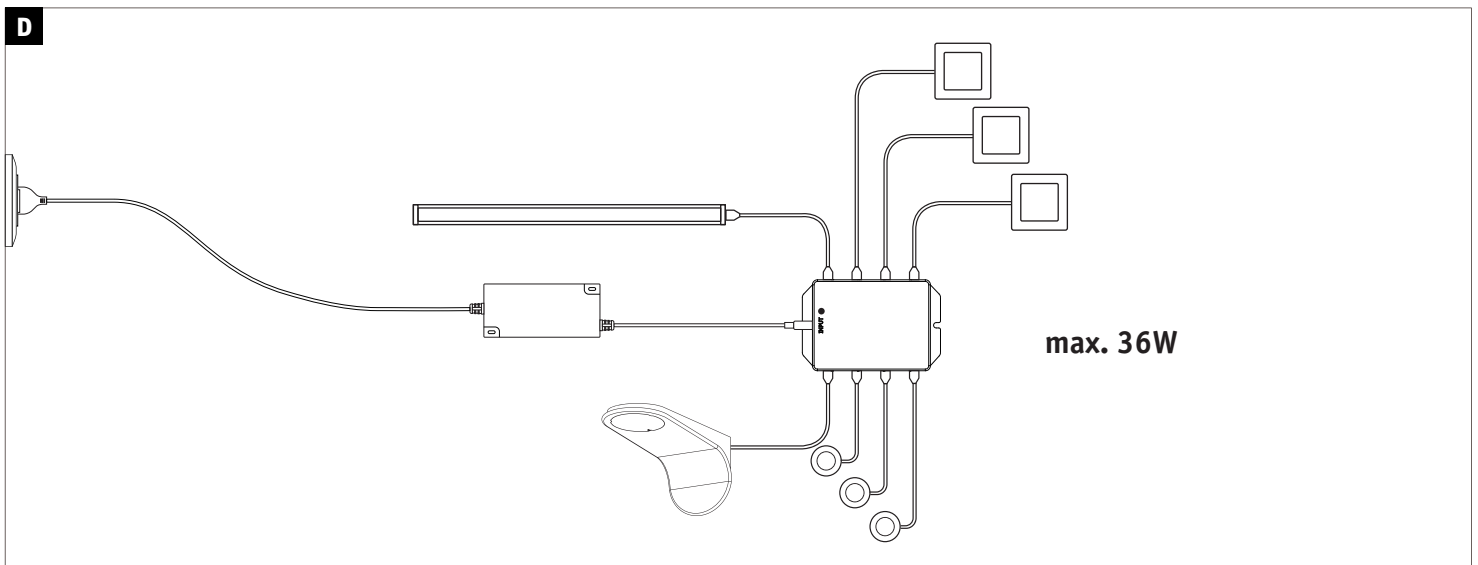
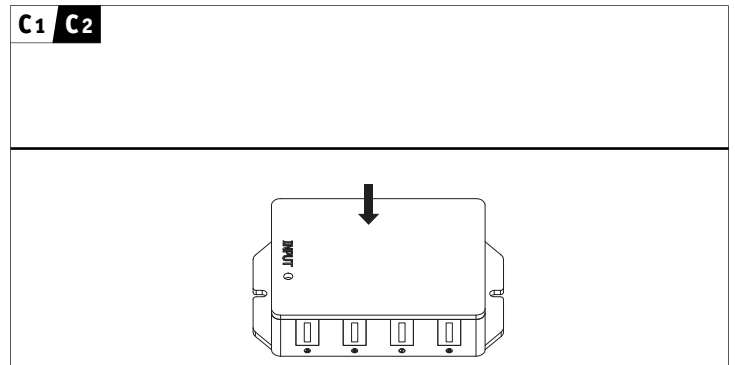
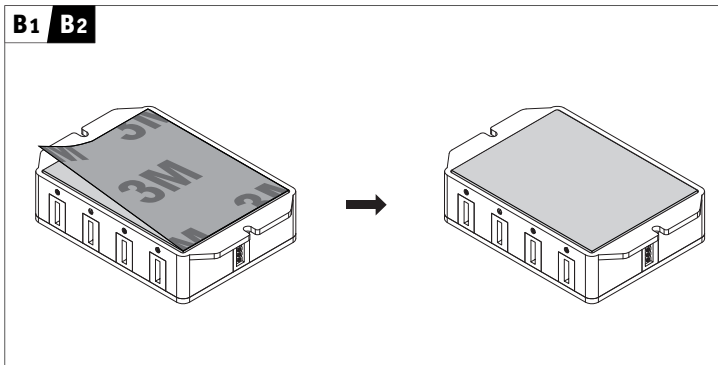
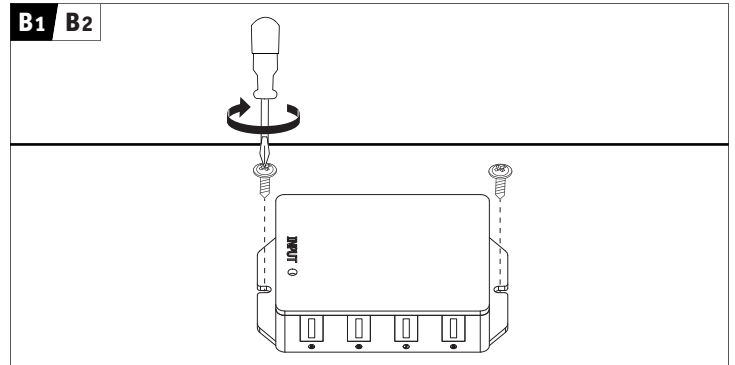
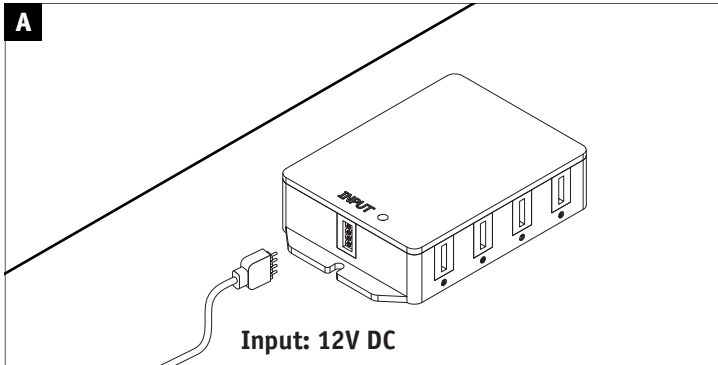
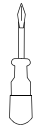

not incl.  
Driver  
12V DC



not incl.  
Paulmann  
Art.-Nr.: 999.52/53  
999.54/55



not incl.  
Paulmann  
Art.-Nr.: 999.56/57

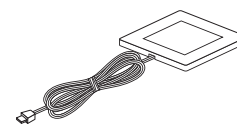

not incl.  
Paulmann  
Art.-Nr.: 999.60/61

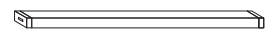

not incl.  
Paulmann  
Art.-Nr.: 999.68/69

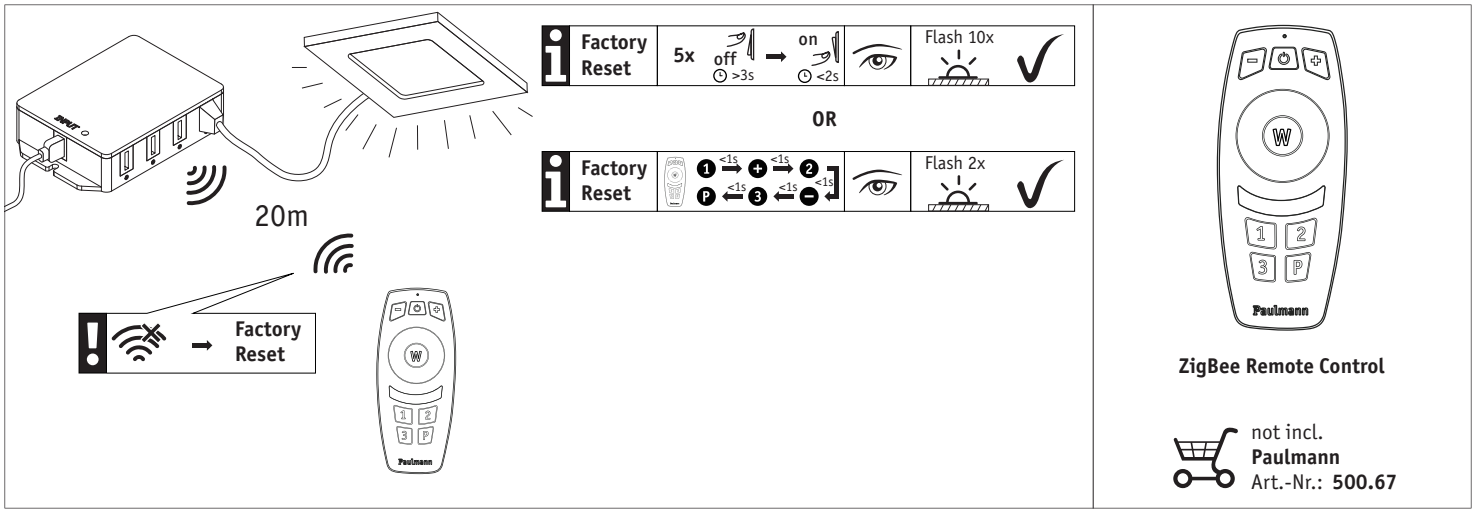

**Factory Reset** 5x off >3s → on <2s Flash 10x ✓

OR

**Factory Reset** 1 <1s 2 <1s 3 <1s P <1s Flash 2x ✓

**ZigBee Remote Control**

not incl. Paulmann Art.-Nr.: 500.67

**Add more Functions**



[www.paulmann.com/zb](http://www.paulmann.com/zb)



not incl. ZigBee 3.0 Gateway

Zugelassen für den Betrieb in allen Ländern der EU / Approved for operating in all European countries  
 CE: Konform mit / in accordance with / conforme a 2014/53/EU <http://www.paulmann.com/ce>

2,4 GHz – 2,4835 GHz



Doesn't apply for the geographical area within a radius of 20km from the centre on "Ny Alesund"

Hiermit erklärt Paulmann Licht, dass der Funkanlagentyp [999.94] der Richtlinie 2014/53/EU entspricht.  
 Der vollständige Text der EU-Konformitätserklärung ist unter der folgenden Internetadresse verfügbar: [www.paulmann.com/ce](http://www.paulmann.com/ce)  
 Funk-Frequenz [2,4 GHz – 2,4835 GHz] Abgestrahlte Energie [10 mW]

 = **D** Altgeräte dürfen nicht in den Restmüll. Sie können bei öffentlichen Sammelstellen von Entsorgungsträgern abgegeben werden. Altbatterien und Akkumulatoren, sowie Lampen, die zerstörungsfrei aus dem Altgerät entnommen werden können, sind vor der Abgabe an eine Erfassungsstelle von dem Altgerät zu trennen. Vertreiber sind im Rahmen von § 17 Absatz 1 und 2 ElektroG zur unentgeltlichen Rücknahme dieses Produktes verpflichtet. Endnutzer von Altgeräten müssen eigenverantwortlich für die Löschung personenbezogener Daten auf den zu entsorgenden Altgeräten sorgen.  
[www.paulmann.com](http://www.paulmann.com)