

Accessories plugs/connectors - Closure cap for CEE plugs



Product description	
BALS-Prd.-Nr	831
EAN	4024941008310
Product category	closure cap
Current	16A
Number of poles	5p
Arrangement of phases	3p+N+PE
Protection degree	IP67
Colour code	grey RAL 7035

Product description	
Height	86mm
Width	76mm
Depth	41.5mm
Material of enclosure	Polyamide

Additional technical properties	
	With strap

Logistics data	
Weight/pcs	0.048 kg / Piece
Packaging	Bag
Content amount	1 ST
EAN	4024941008310
Length	41.5 mm
Width	76 mm
Height	86 mm
Weight	0.049 kg
Volume	271.244 ccm
Packaging	Carton
Content amount	10 ST
EAN	4024941959759
Length	275 mm

Logistics data	
Width	175 mm
Height	137 mm
Weight	0.605 kg
Volume	5,737.5 ccm

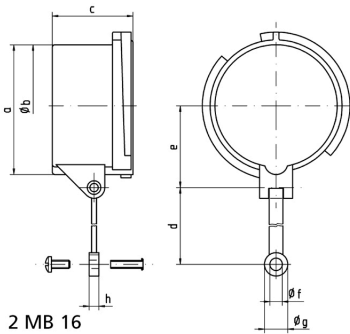

Ampere Polzahl	16 3	16 4	16 5	32 3/4	32 5	63 3/4/5	125 3/4/5
a	53,0	59,5	67,0	70,0	76,5	83,5	95,5
b ø	49,5	55,7	63,0	64,0	70,5	76,5	89,0
c	41,5	41,5	41,5	51,5	51,5	72,5	80,0
d	133,0	133,0	133,0	133,0	133,0	155,0	155,0
e	34,5	38,0	42,0	44,0	48,0	52,0	57,5
f ø	6,4	6,4	6,4	6,4	6,4	6,4	6,4
g ø	12,0	12,0	12,0	12,0	12,0	12,0	12,0
h	5,0	5,0	5,0	5,0	5,0	5,0	5,0