

FLIR 400.3040.01

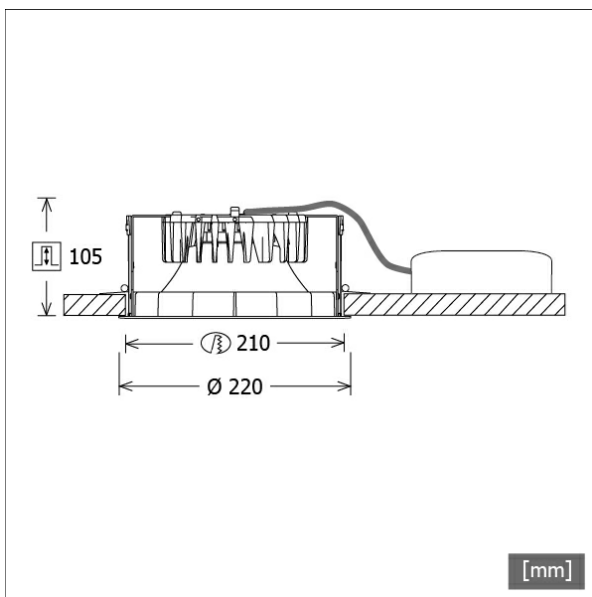

Farbe	Artikelnummer	EAN
schwarz	636673	4043544392558
silber	636674	4043544392565
weiß	636675	4043544392572



Beschreibung

- Einbau-Downlight mit optischen Designvarianten für Allgemeinbeleuchtung
- hohe Wartungsfreundlichkeit
- keine UV- und Wärmestrahlung
- innovatives Wärmemanagement mit Passivkühlung (Kühlkörper aus Aluminiumdruckguss)
- High-Performance Spiegelreflektor aus Aluminium mit präziser symmetrischer Abstrahlcharakteristik für maximale Lichtausbeute und optimale Entblendung
- Front-/Einbauring aus Zinkdruckguss mit Lichteffektring klar (weitere Dekor-/Lichteffektringe und Dekogläser sind als Option erhältlich)
- werkzeugloser Deckeneinbau mit Schnellspannautomatik (automatische Anpassung der Deckenstärke)
- Anschluss an Betriebsgerät über vormontiertes Leuchtenkabel
- Betriebsgerät (LED-Konverter) inklusive (Platzierung extern)

Standardoptionen



Sonderoptionen



Lichttechnik / Normen

Leuchtmittel	LED Modul / CRI 80 / 4000 K
EPREL Lichtquellen	891020
Lebensdauer	L90 B50 50.000 h L80 B50 100.000 h L80 B20 50.000 h
Systemleistung	26.0 W
Leuchten-Lichtstrom	max. 3040 lm
Systemeffizienz	116.92 lm/W
Moduleffizienz	123.23 lm/W
UGR Klasse	≤25
Abstrahlwinkel	75°
Versorgungsspannung	220 - 240 V / 50 - 60 Hz
Schutzklasse	III
Schutzart	IP20

Abmessungen / Gewichte

Außendurchmesser	220 mm
Höhe	107 mm
Ausschnittsmaß (∅)	210 mm
Deckenstärke	5.0 - 50.0 mm
Einbautiefe	105 mm
Nettogewicht	1.25 kg
Bruttogewicht	1.32 kg

FLIR 400.3040.01

Flixx 400 Round (FLIRZ 400.05, 1xLED 26W 840/4000K 3040lm 75 °)

— C0/C180 cd / 1000 lm

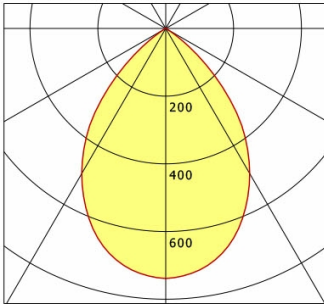

	C0	C90	C180	C270
0°	739	739	739	739
15°	678	678	678	678
30°	495	495	495	495
45°	220	220	220	220
60°	7	7	7	7
75°	4	4	4	4
90°	0	0	0	0
cd / 1000 lm				

Offset [m] Cone width [m] Illuminance [lx]

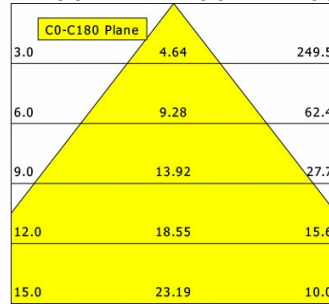

η	LED
Efficiency	117 lm/W
Direct/Indirect	↓ 100% / ↑ 0%
System Power	26 W
UGR	X=4H, Y=8H
Reflection factors	70/50/20
UGR C0/C180	20.7
UGR C90/C270	20.7
CIE Flux Codes	81 99 100 100 100
Ra/CRI	>80

LTS

Flixx 400 Round (FLIRZ 400.24, 1xLED 26W 840/4000K 2900lm 75 °)

— C0/C180 cd / 1000 lm

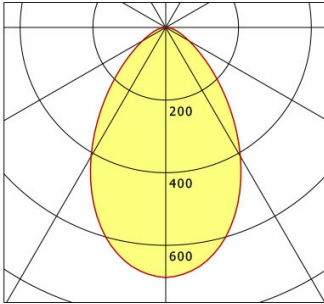

	C0	C90	C180	C270
0°	689	689	689	689
15°	610	610	610	610
30°	410	410	410	410
45°	197	197	197	197
60°	74	74	74	74
75°	26	26	26	26
90°	0	0	0	0
cd / 1000 lm				

Offset [m] Cone width [m] Illuminance [lx]

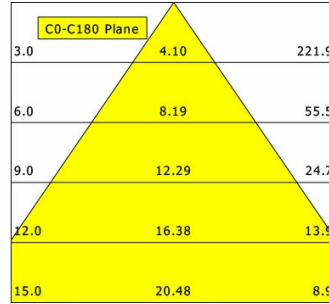

η	LED
Efficiency	112 lm/W
Direct/Indirect	↓ 100% / ↑ 0%
System Power	26 W
UGR	X=4H, Y=8H
Reflection factors	70/50/20
UGR C0/C180	24.0
UGR C90/C270	24.0
CIE Flux Codes	69 91 98 100 100
Ra/CRI	>80

LTS

Flixx 400 Round (FLIRZ 400.25, 1xLED 26W 840/4000K 2990lm 75 °)

— C0/C180 cd / 1000 lm

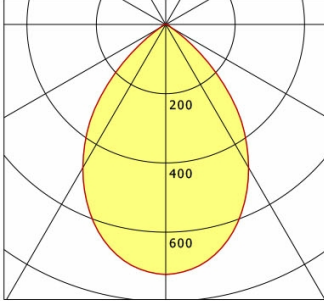

	C0	C90	C180	C270
0°	722	722	722	722
15°	657	657	657	657
30°	478	478	478	478
45°	222	222	222	222
60°	19	19	19	19
75°	8	8	8	8
90°	0	0	0	0
cd / 1000 lm				

Offset [m] Cone width [m] Illuminance [lx]

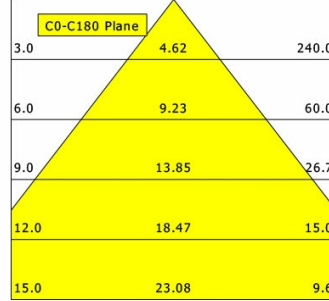

η	LED
Efficiency	115 lm/W
Direct/Indirect	↓ 100% / ↑ 0%
System Power	26 W
UGR	X=4H, Y=8H
Reflection factors	70/50/20
UGR C0/C180	21.1
UGR C90/C270	21.1
CIE Flux Codes	78 98 100 100 100
Ra/CRI	>80

LTS

FLIRZ 400.3040.01

Zubehör



FLIRZ 400.01
Dekorring schwarz



FLIRZ 400.02
Dekorring silber



FLIRZ 400.03
Dekorring weiß



FLIRZ 400.04
Lichtefferkring opal



FLIRZ 400.05
Lichtefferkring klar



FLIRZ 400.06
Lichtefferkring rot matt



FLIRZ 400.07
Lichtefferkring gelb matt



FLIRZ 400.08
Lichtefferkring blau matt



FLIRZ 400.16
Lichtefferkring rot transluzent



FLIRZ 400.17
Lichtefferkring gelb transluzent



FLIRZ 400.18
Lichtefferkring blau transluzent



FLIRZ 400.24
Dekoglas opal



FLIRZ 400.25
Dekoglas klar



NOL 50B/3H/DALI
LED-Notlichteinheit



ZDAR 207.250-310
Ausgleichsring für Deckenausschnitte von 250 – 310 mm



ZVP 100
Universalverstärkungsrahmen
(Modul 625 x 625)