

FLIR 200.2030.35

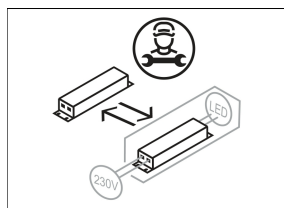

Farbe	Artikelnummer	EAN
schwarz	636607	4043544391896
silber	636608	4043544391902
weiß	636609	4043544391919

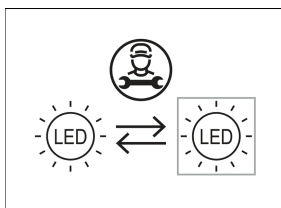
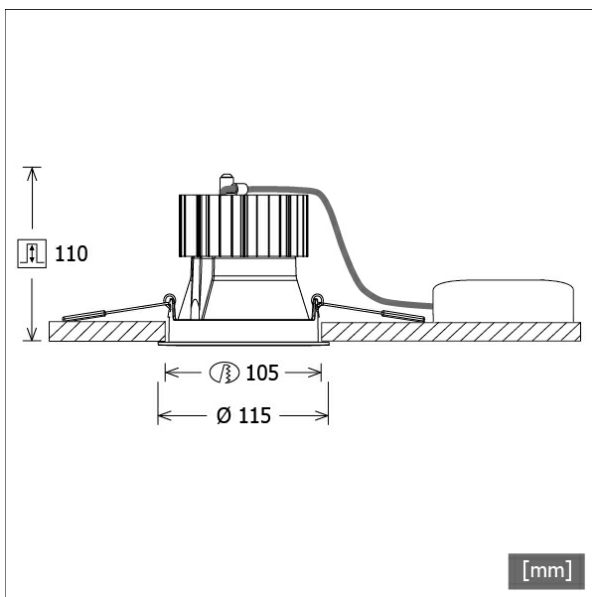

Beschreibung

- Einbaustrahler mit optischen Designvarianten und breitem Anwendungsspektrum
- Lichtkopf 20° schwenkbar
- hohe Wartungsfreundlichkeit
- keine UV- und Wärmestrahlung
- Wärmemanagement mit Passivkühlung (Kühlkörper aus Aluminium)
- High-Performance Spiegelreflektor aus Aluminium mit präziser symmetrischer Abstrahlcharakteristik für maximale Lichtausbeute und optimale Entblendung
- Front-/Einbauring aus Zinkdruckguss mit Lichteffektring klar (weitere Dekor-/Lichteffektringe und Dekogläser sind als Option erhältlich)
- werkzeugloser Deckeneinbau mit Schnellspannfedern (automatische Anpassung der Deckenstärke)
- Anschluss an Betriebsgerät über Leuchtenkabel mit Mini-Clamp Steckverbindung
- Betriebsgerät (LED-Konverter) inklusive (Platzierung extern)

Standardoptionen



Sonderoptionen



Lichttechnik / Normen

Leuchtmittel	LED Spot / CRI 80 / 3000 K
EPREL Lichtquellen	848117
Lebensdauer	L90 B50 50.000 h
	L80 B50 100.000 h
	L80 B20 50.000 h
Systemleistung	27,0 W
Leuchten-Lichtstrom	max. 2950 lm
Systemeffizienz	109,25 lm/W
Moduleffizienz	156,64 lm/W
UGR Klasse	≤28
Abstrahlwinkel	35°
Versorgungsspannung	220 - 240 V / 50 - 60 Hz
Schutzklasse	III
Schutzart	IP20

Abmessungen / Gewichte

Außendurchmesser	115 mm
Höhe	112 mm
Ausschnittsmaß (Ø)	105 mm
Deckenstärke	1,0 - 25,0 mm
Einbautiefe	110 mm
Nettogewicht	0,87 kg
Bruttogewicht	0,95 kg

FLIR 200.2030.35

Flixx 200 Round (FLIRZ 200.05, 1xLED 27W 830/3000K 2950lm 35 °)

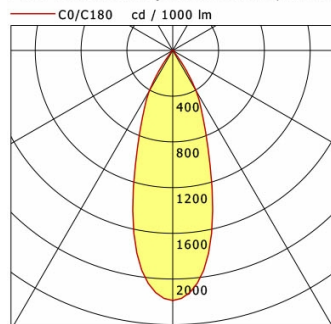

	C0	C90	C180	C270
0°	2188	2188	2188	2188
15°	1344	1344	1344	1344
30°	409	409	409	409
45°	18	18	18	18
60°	14	14	14	14
75°	6	6	6	6
90°	0	0	0	0

cd / 1000 lm

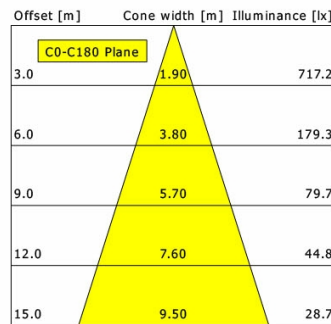

η	LED
Efficiency	109 lm/W
Direct/Indirect	↓ 100% / ↑ 0%
System Power	27 W
UGR	X=4H, Y=8H
Reflection factors	70/50/20
UGR C0/C180	20.6
UGR C90/C270	20.6
CIE Flux Codes	96 98 100 100 100
Ra/CRI	>80

LTS

Flixx 200 Round (FLIRZ 200.24, 1xLED 27W 830/3000K 2780lm 35 °)

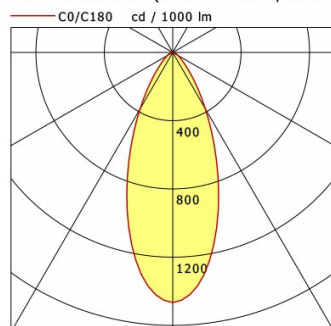

	C0	C90	C180	C270
0°	1466	1466	1466	1466
15°	1014	1014	1014	1014
30°	382	382	382	382
45°	104	104	104	104
60°	37	37	37	37
75°	15	15	15	15
90°	0	0	0	0

cd / 1000 lm

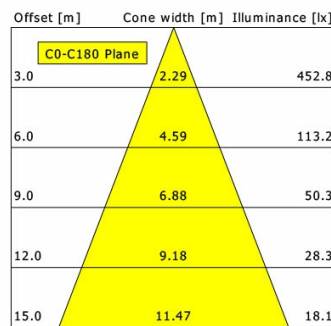

η	LED
Efficiency	103 lm/W
Direct/Indirect	↓ 100% / ↑ 0%
System Power	27 W
UGR	X=4H, Y=8H
Reflection factors	70/50/20
UGR C0/C180	26.1
UGR C90/C270	26.1
CIE Flux Codes	84 95 99 100 100
Ra/CRI	>80

LTS

Flixx 200 Round (FLIRZ 200.25, 1xLED 27W 830/3000K 2870lm 35 °)

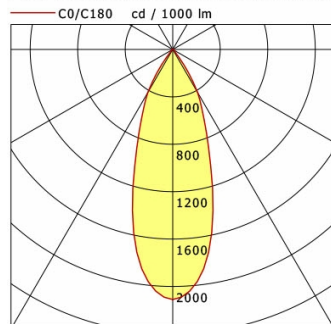

	C0	C90	C180	C270
0°	2110	2110	2110	2110
15°	1310	1310	1310	1310
30°	419	419	419	419
45°	21	21	21	21
60°	16	16	16	16
75°	5	5	5	5
90°	0	0	0	0

cd / 1000 lm

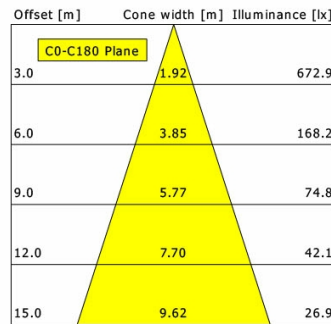

η	LED
Efficiency	107 lm/W
Direct/Indirect	↓ 100% / ↑ 0%
System Power	27 W
UGR	X=4H, Y=8H
Reflection factors	70/50/20
UGR C0/C180	20.7
UGR C90/C270	20.7
CIE Flux Codes	95 98 100 100 100
Ra/CRI	>80

LTS

FLIRZ 200.2030.35

Zubehör



FLIRZ 200.01
Dekorring schwarz



FLIRZ 200.02
Dekorring silber



FLIRZ 200.03
Dekorring weiß



FLIRZ 200.04
Lichteffektring opal



FLIRZ 200.05
Lichteffektring klar



FLIRZ 200.06
Lichteffektring rot matt



FLIRZ 200.07
Lichteffektring gelb matt



FLIRZ 200.08
Lichteffektring blau matt



FLIRZ 200.16
Lichteffektring rot transluzent



FLIRZ 200.17
Lichteffektring gelb transluzent



FLIRZ 200.18
Lichteffektring blau transluzent

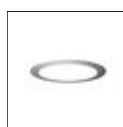

FLIRZ 200.24
Dekoglas opal



FLIRZ 200.25
Dekoglas klar