

# Wallbox ABL Pulsar

## Charging station with fixed charging cable 11 kW

The Wallbox ABL Pulsar is an intelligent home charging station. It was developed with the aim of saving users not only time and money, but literally energy. This compact wallbox offers extremely fast charging speeds while also minimising daily energy consumption so that drivers can use their electric vehicle as efficiently as possible.

### Simple installation and operation

Thanks to its compact dimensions and simple installation, the Wallbox ABL Pulsar is ready to use straight away. With wireless communication via WLAN or Bluetooth, users can easily adjust and monitor the operating parameters to suit their requirements using the free Wallbox app. The fixed charging cable (5 m) ensures ease of use.

### Intelligent load management

When used with the optional Energy Meter Pulsar, the Wallbox ABL Pulsar offers various energy management solutions. Solar Charging mode makes efficient use of a PV system and offers functions that ensure an optimum ratio of solar power and grid power for the charging process: Automatic phase switching can be used to optimise the use of the available charging current. Dynamic load management ensures maximum charging power, taking into account the upper current limit available in the domestic power distribution.







### Flexibility and security

The Wallbox ABL Pulsar complies with protection class IP55 and is certified for the highest impact resistance rating IK10. It guarantees reliable operation thanks to its robust housing and integrated DC residual current detection. The optionally available POLE Pulsar Eiffel Basic mounting pole is designed for outdoor installation, with the optional Pulsar Eiffel Basic weather shield providing additional protection against environmental conditions.



Product number 100000446

### Product advantages

-  Setup and monitoring via Wallbox app
-  Energy and cost-optimised charging with Solar Charging
-  Dynamic load management via Energy Meter Pulsar
-  Company car driver billing via MID Meter Pulsar
-  Automatic phase switching
-  IP55 and IK10

## General information

Model	Wallbox ABL Pulsar
Manufacturer number	PLP3-0-2-3-9-AB2
Product number	100000446
EAN number	8436607544814
Commodity code	85371091
Packaging unit (PU)	1 unit
Packaging (dimensions H×W×D)	400 × 400 × 190 mm
Weight of packaging unit	Approx. 5.16 kg
Items supplied	Wallbox, printed installation instructions, plug holder, installation kit, user information

## Input / mains supply

External power supply	Supply cable with cable cross-section up to a maximum of 13 mm <sup>2</sup> or cable diameter ≤ 22 mm
Rated voltage	230 / 400 V (3-phase)
Rated current	16 A
Rated frequency	50 / 60 Hz
Upstream fuse	16 A (required on-site), C characteristic recommended
Connection	Direct connection to the terminal block

## Output / vehicle connection

Connection system	Single charging cable with type 2 connector in acc. with IEC 62196-2, approx. 5 m
Output voltage	230 / 400 V
Max. charging current	16 A
Maximum charging power (3-phase)	1 × 11 kW
Maximum charging power (1-phase)	1 × 3.7 kW

## Protection / integrated components

DC fault current detection	Electronic, $I_{\Delta n \text{ d.c.}} \geq 6 \text{ mA}$
Load switching	Relay, 2 × 2-pole, 40 A
Weld detection	No charging possible when the relay is welded
Temperature monitoring	Internal, charging current reduction or shut down

## Communication / interfaces

Operating status indicator	LED
Access control	App
Communication EV	In acc. with IEC 61851-1 Mode 3
Communication app/portal	WLAN, Bluetooth
Supported protocols for external systems	OCPP 1.6, API
Load shedding	Potential-free contact in accordance with VDE-AR-N 4100

## Standards / directives

IEC 61851-1 | IEC 61851-21-2

## Operating conditions

Storage temperature	-30 to 75°C
Operating temperature	-30 to 50°C
Relative humidity	5 to 95%, no condensation
Class of protection	I
Overvoltage category	III
Degree of pollution	3
Degree of protection (housing)	IP55
Impact strength	IK10
Maximum elevation	≤ 2,000 m AMSL
Idle power	< 5 W

## Housing

Type	Wall-mounted housing
Fixing type	Wall mounting using wall plate and installation kit
Material (housing/cover)	Plastic
Colour (housing/cover)	Black
Dimensions (H×W×D)	201 × 198 × 99 mm (housing base without charging cable)
Weight (net)	Approx. 4.16 kg

### Optional accessories

POLE Pulsar Eiffel Basic mounting pole	100000448
Pulsar Eiffel Basic weather shield	100000449
Energy Meter Pulsar	100000450
MID Meter Pulsar	100000495

### Dimensioned drawing

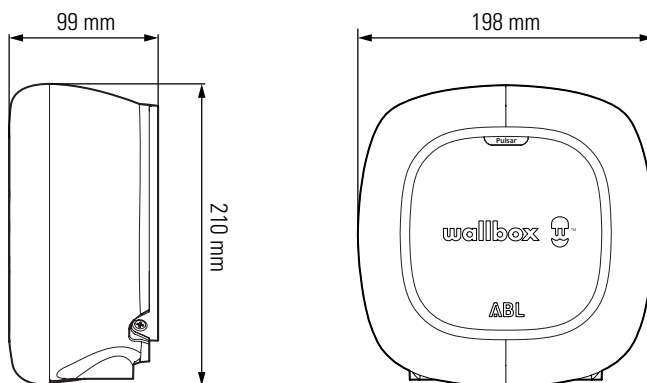

Subject to change: All performance characteristics, technical and other specifications are subject to change without prior notice.

Revision status ABL\_100000446\_EN\_c, 08/24

ABL GmbH • Albert-Büttner-Straße 11 • D-91207 Lauf / Pegnitz • Tel. +49 (0) 9123 188-0 • info@abl.de • www.abl.de • www.ablmobility.de

Wall Box Chargers S.L.U. • Carrer del Foc, 68 • 08038 Barcelona • Spain • www.wallbox.com