

plug - with TE screw terminals, for harsh applications



Product description	
BALS-Prd.-Nr	21785
EAN	4024941217859
Product category	TE plug
Current	63A
Number of poles	5p
Arrangement of phases	3p+N+PE
Position of earth contact	1 h
Voltage	> 50V for all other not classified voltages and/or frequencies. This time position can additionally process in special applications, in which a distinction to standardized positions needed to be used.

Product description	
Protection degree	IP44
Colour code	grey RAL 7035
Colour of appliance	Collar grey RAL 7035, Pusher black RAL 9005, Housing cover dark grey RAL 7012, Cable gland dark grey RAL 7012
Connection design	screw terminal as box terminal
Maximum conductor size	16,0 qmm
Cable entry	with cable gland
Height	234mm
Width	97mm
Depth	98mm
Material of enclosure	Polyamide
Contacts	The contact carrier is made of high temperature resistant material, the contacts are brass nickel plated

Additional technical properties	
	For cable diameter from 16 up to max. 36 mm, Screwless housing connection, Multi-Grip cable gland with gasket and integrated strain relief

Logistics data	
Weight/pcs	0.655 kg / Piece
Packaging	Bag
Content amount	1 ST
EAN	4024941217859

Logistics data	
Length	98 mm
Width	97 mm
Height	234 mm
Weight	0.656 kg
Volume	2,224.404 ccm
Packaging	Carton
Content amount	5 ST
EAN	4024941822558
Length	325 mm
Width	217 mm
Height	210 mm
Weight	3.481 kg
Volume	13,588.4 ccm

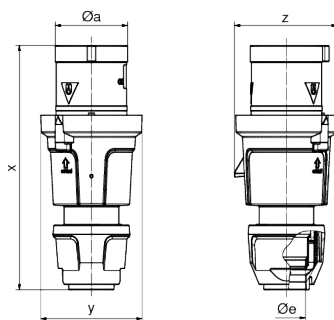

	63	63	63
Ampere	3	4	5
Polzahl	3	4	5
ø a	69,0	69,0	69,0
ø e	36,0	36,0	36,0
x	233,0	233,0	233,0
y	97,0	97,0	97,0
z	98,0	98,0	98,0
Cond. mm ² min	6,0	6,0	6,0
Cond. mm ² max	16,0	16,0	16,0