

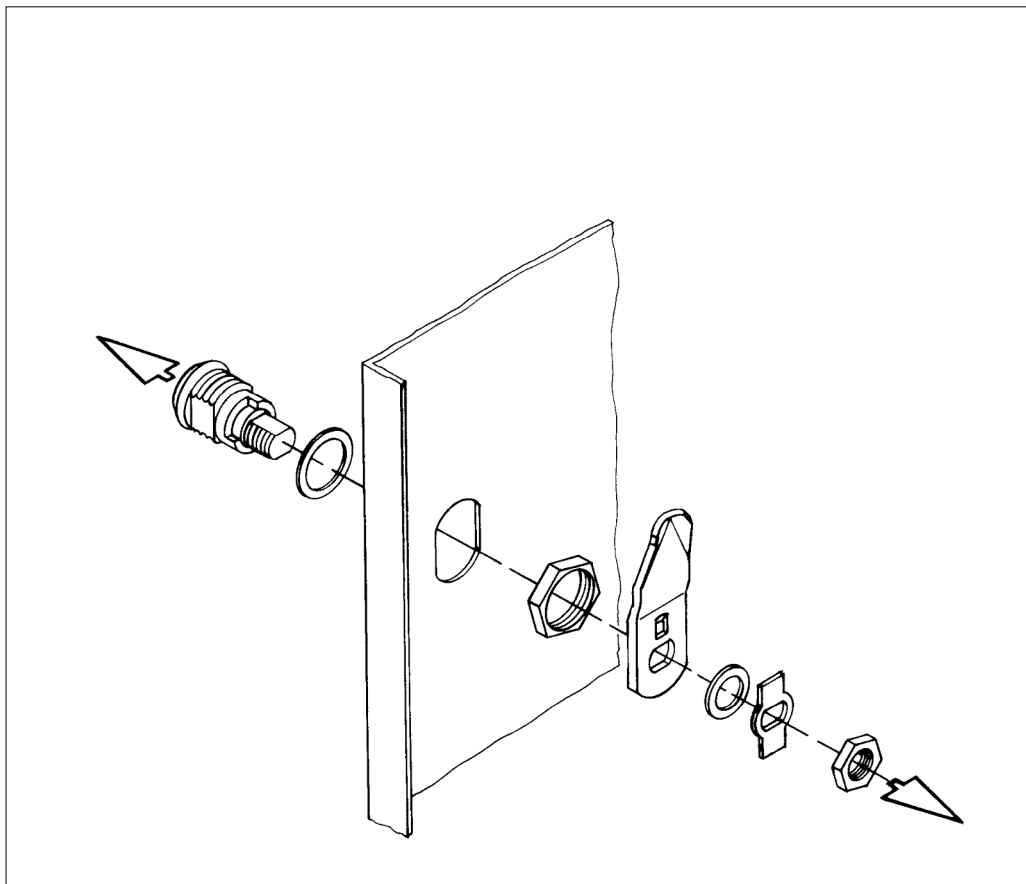

SZ
2485.100

Raum für Verpackungsdatum
Area for date of packing
(MMJJTT / MMYDD)



Zchn.-Nr. / No. of dwg. : A3234401SZ

Versandbeutel-Nr. / No. of accessory bag : -

Lieferanten-Nr. / No. of supplier :

