

9002/13-252-121-041 Art. No. 158830



- For the intrinsically safe operation of a wide range of devices, such as HART transmitters, solenoid valves, sensors, zero-potential contacts and many more
- Compact, space-saving devices that are easy to install on a DIN rail
- Quick and efficient installation as barriers can be simultaneously snapped onto DIN rail and connected to ground (ISA - RP112.06)

WebCode **9002A**



The 9002 series INTRINSPAK two-channel zener barriers enable the intrinsically safe operation of virtually all field devices. The comprehensive portfolio and the combination of zener barriers cover a wide variety of signals. The devices are incredibly robust and require very little space. The back-up fuse is a convenient feature as it is standardized for all variants.

Technical Data

Explosion Protection

Application range (zones)	2
Ex interface zone	0 1 2 20 21 22
IECEX gas certificate	IECEX PTB 08.0057X
IECEX gas explosion protection	Ex nA [ia Ga] IIC/IIB T4 Gc
IECEX dust certificate	IECEX PTB 08.0057X
IECEX dust explosion protection	[Ex ia Da] IIIC
ATEX gas certificate	PTB 01 ATEX 2053 X
ATEX gas explosion protection	⊕ II 3 (1) G Ex nA [ia Ga] IIC/IIB T4 Gc
ATEX dust certificate	PTB 01 ATEX 2053 X
ATEX dust explosion protection	⊕ II (1) D [Ex ia Da] IIIC
Certificate FMus	3010778
Marking FMus	NONINCENDIVE FOR, Class I, Div. 2, Groups A,B,C,D; T4, Class I, Zone 2, Group IIC T4 IS connections for Class I,II,III, Div. 1, Groups A,B,C,D,E,F,G; Class I, Zone 0, Groups IIC/IIB Hazardous location when inst. per doc. 90 026 11 31 1
Certificate ULus	E81680V1S3
Marking ULus	For use in Hazardous location, Class I, Div. 2, Groups A,B,C,D; T4 Providing IS circuits for Class I,II,III, GROUPS A,B,C,D,E,F,G; per doc. 90 026 11 31 3
Certificate cCSA	1284580

9002/13-252-121-041 Art. No. 158830

Explosion Protection

Marking cCSA	Associated equipment [Ex ia], Class I, Div. 2, Groups A,B,C,D; Provides IS circuits for Class I,II,III, Class I, Zone 0, Groups IIC/IIB For applicable grps per inst. doc. 90 016 11 31 2
EAC certificate	TS RU C-DE.ГБ04.B.00651
EAC gas explosion protection	Ex 2 Ex nA [ia Ga] IIC T4 Gc X
EAC dust explosion protection	Ex [Ex ia Da] IIC
Inmetro gas certificate	UL-BR 12.0354
Inmetro dust certificate	UL-BR 12.0354
Certificates	ATEX (PTB), Brazil (ULB), Canada (CSA), China (CQST), EAC (STV), IECEx (PTB), India (PESO), Japan (CML), Korea (KGS), USA (FM), USA (UL)
Installation	in Zone 2, Division 2 and in safe area
Further information	see respective certificate and operating instructions

Safety Data

Maximum voltage U_o	25.2 V
Maximum current I_o	118 mA
Maximum power P_o	740 mW
Max. permissible external capacitance C_o for IIC	0.107 μ F
Max. permissible external capacitance C_o for IIB	0.82 μ F
Max. permissible external inductance L_o for IIC	1.3 mH
Max. permissible external inductance L_o for IIB	7.4 mH

Electrical Data

Number of channels	2					
Rated operational voltage DC	22 V					
Maximum resistance R_{max}	244 Ω					
Minimum resistance R_{min}	217 Ω					
Maximum output current I_{max}	86 mA					
Potential	Positive potential with diode feedback					
Potential Ch 1	Positive potential					
Potential Ch 2	Evaluation barrier +potential					
Ohmic current limiting using frequency \geq 50 mA	\leq 100 kHz					
Ohmic current limiting using frequency \leq 50 mA	\leq 50 kHz					
Leakage current I_{leck} for U_N	35 V \leq 10 mA					
Channel	Nominal voltage U_N	Minimum resistance R_{min}	Maximum resistance R_{max}	Maximum voltage U_o	Maximum current I_o	Maximum power P_o
1	20-35 V	217.00 Ω	244.00 Ω	25.20 V	118.0 mA	740.000 mW
2	22.00 V			25.20 V	0.0 mA	20.000 mW
1 + 2				25.20 V	121.0 mA	760.000 mW

Auxiliary Power

Nominal voltage	20 ... 35 V
Power supply	Uncontrolled, 20 – 35 V DC

9002/13-252-121-041 Art. No. 158830

Ambient Conditions

Ambient temperature	-20 °C ... +60 °C
Ambient temperature	-4°F ... +140°F
Storage temperature	-20 °C ... +75 °C
Storage temperature	-4°F ... +167°F
Relative humidity max.	95% on average, no condensation
Temperature influence	≤ 0,25 %/10K

Mechanical Data

Degree of protection (IP)	IP40
Terminal degree of protection (IP)	IP20
Enclosure material	Polyamide 6GF
Number of connection terminals	4
Connection cross section max.	1.5 mm ²
Connection cross-section AWG	... 16 AWG
Type of connection cable	Finely stranded Solid
Width	103 mm
Width inches	4.09 in
Length	12 mm
Length inches	0.48 in
Mounting depth	72 mm
Mounting depth inches	2.76 in
Weight	0.11 kg
Weight	0.24 lb

Mounting / Installation

Connection cross-section ground	4 mm ²
Cross-section ground AWG	12 AWG
Connection type	2 PA
Min. torque Nm	0.5 Nm
Min. torque lb / in	4.43 lb / in
Max. torque Nm	0.6 Nm
Max. torque lb / in	5.31 lb / in

Technical Drawings – Subject to Alterations

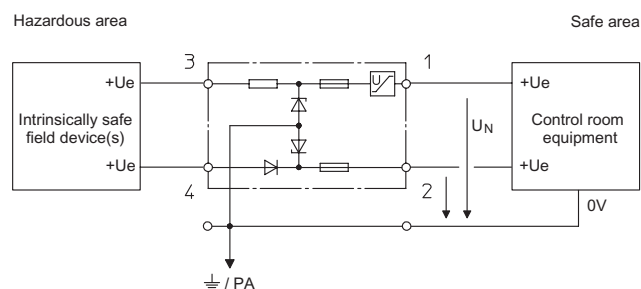

Two-channel safety barriers, safety barrier potential: + / evaluation barrier potential: +

Safety Barriers

Dual-channel safety barrier



9002/13-252-121-041 Art. No. 158830

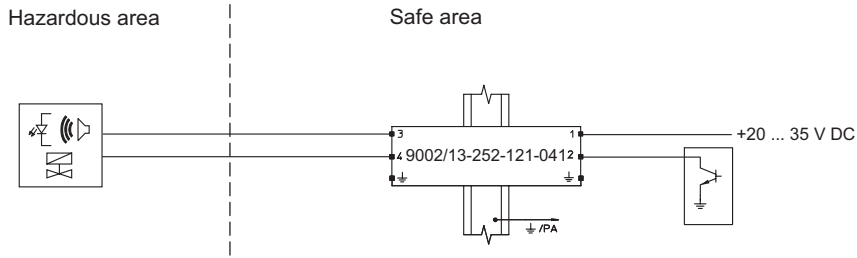

Application: Analog output (current source) for I/P converter etc., field circuit unearthed

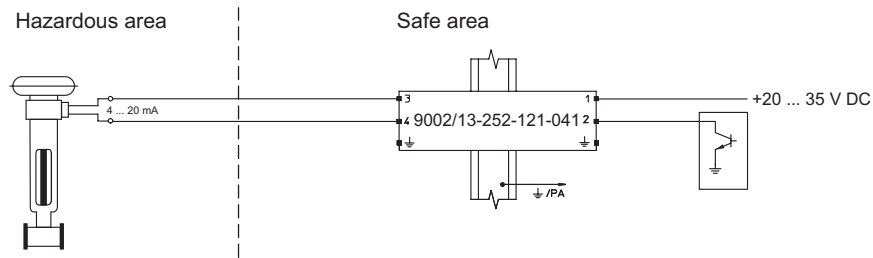

Application: Analog output (current source) for I/P converter etc., field circuit unearthed

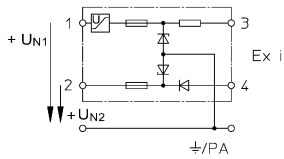

Picture N

Dimensional Drawings (All Dimensions in mm [inches]) – Subject to Alterations

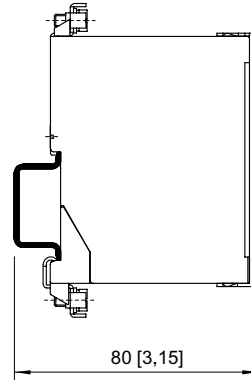
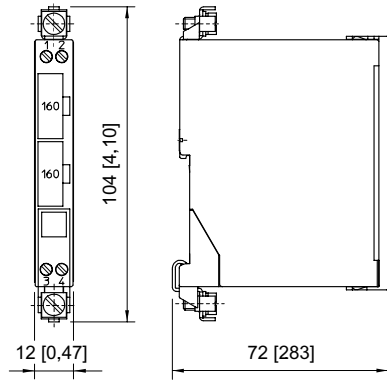

Mounting on DIN rail NS 35/15

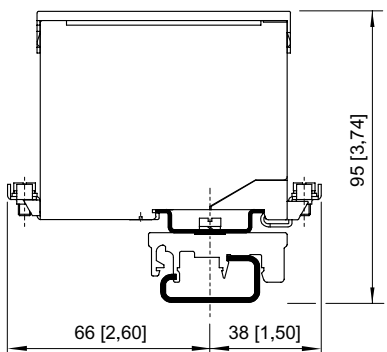

Mounting on DIN rail NS 32 by means of adaptor and mounting attachment, moulded plastic

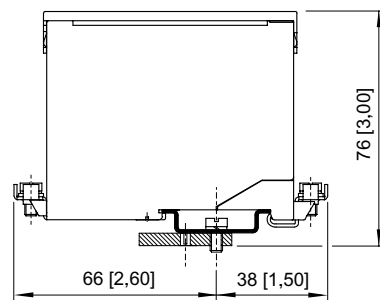

Mounting on mounting plate by means of adaptor

9002/13-252-121-041 Art. No. 158830

Accessories and Spare Parts

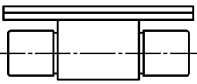
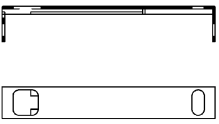
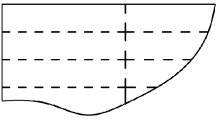
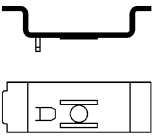
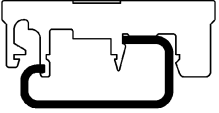
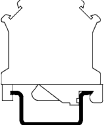
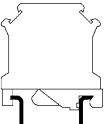
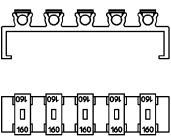
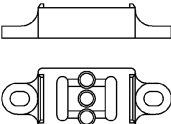
		Art. No.
Back-up fuse		
	For all safety barriers Series 9001, 9002 and 9004 Packaging unit: 5 pcs.	158964
Holder for label		
	Transparent cover for labelling	158977
Labelling paper		
	Perforated, for typing Format: DIN A4 Packaging unit: 80 pieces	158973
Adaptor		
	Adaptor allows installation of a safety barrier Series 900x on a mounting plate of a previous series.	158826
Mounting attachment moulded plastic		
	Enables mounting of safety barrier on a G-rail.	165283
Protective conductor terminal		
	USLKG 5 (wire range 4 mm ²) Terminal enables connection of protective conductors to DIN rail. Colour green-yellow.	112760
Earth terminal		
	USLKG 6 N (wire range 6 mm ²) Terminal enables connection of protective / earthing conductors to DIN rail. Colour green-yellow.	112599
Fuse holder		
	Fuse holder is snapped onto the side of the safety barrier and can be equipped with up to 5 back-up fuses (replacement).	158834
Insulating stand off		
	Suitable for DIN rail NS35/15, allows electrically insulated mounting of DIN rail from mounting plate.	158828

Safety Barriers

Dual-channel safety barrier



9002/13-252-121-041 Art. No. 158830

We reserve the right to make alterations to the technical data, dimensions, weights, designs and products available without notice. The illustrations cannot be considered binding.