

panel mounting socket outlet, straight - flange 75x75,
fixing centers 60x60



Product description	
BALS-Prd.-Nr	13005
EAN	4024941130059
Product category	Panel mounting socket outlet, straight
Current	16A
Number of poles	5p
Arrangement of phases	3p+N+PE
Position of earth contact	6 h
Voltage	200/346 - 240/415V~

Product description	
Frequency	50/60Hz
Protection degree	IP44
Colour code	red RAL 3000
Colour of appliance	Hinged lid red RAL 3000, Enclosure grey RAL 7035
Connection design	with screw terminal
Maximum conductor size	4,0 qmm
Cable entry	other
Height	86mm
Width	75mm
Depth	71mm
Flange size vertical in mm	75mm
Flange size horizontal in mm	75mm
Drill hole dist. vertical mm	60mm
Drill hole dist. horizontal mm	60mm
Material of enclosure	Polyamide
Contacts	The contact carrier is made of polyamide, The contacts are brass

Logistics data	
Weight/pcs	0.149 kg / Piece
Packaging	Bag
Content amount	1 ST

Logistics data	
EAN	4024941130059
Length	71 mm
Width	75 mm
Height	86 mm
Weight	0.15 kg
Volume	457.95 ccm
Packaging	Carton
Content amount	10 ST
EAN	4024941821049
Length	245 mm
Width	177 mm
Height	185 mm
Weight	1.623 kg
Volume	7,140 ccm

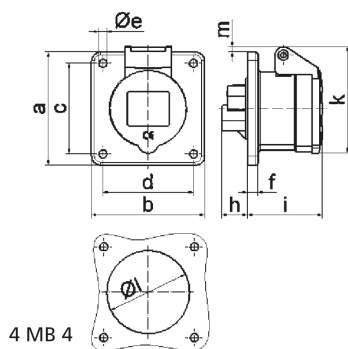

Ampere Polzahl	16 3	16 4	16 5	32 3	32 4	32 5
a	75,0	75,0	75,0	75,0	75,0	75,0
b	75,0	75,0	75,0	75,0	75,0	75,0
c	60,0	60,0	60,0	60,0	60,0	60,0
d	60,0	60,0	60,0	60,0	60,0	60,0
e ø	5,5	5,5	5,5	5,5	5,5	5,5
f	7,0	7,0	7,0	8,0	8,0	8,0
h	17,0	26,0	17,0	36,0	36,0	19,0
i	51,0	53,0	53,0	62,0	62,0	62,0
k	70,0	80,0	85,0	90,0	90,0	98,0
l ø	45,0	45,0	55,0	60,0	60,0	60,0
m	3,5	7,0	11,5	12,0	12,0	17,0
Leiter mm ² min	1,5	1,5	1,5	2,5	2,5	2,5
Leiter mm ² max	4	4	4	10	10	10