

060

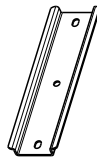

100

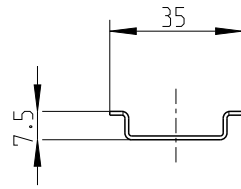
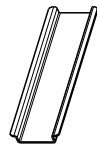

100
TOPJOB

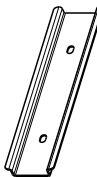

160

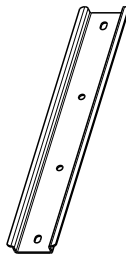

250/
350

1:5

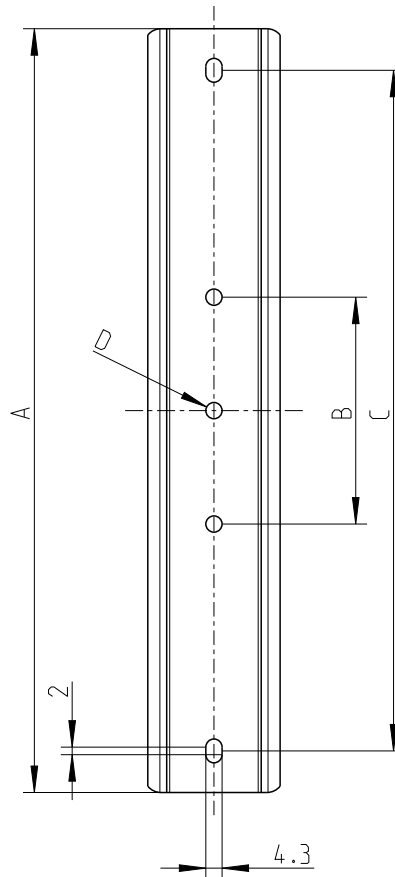

Form 1
shape 1

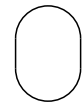

Form 2
shape 2

Größe/ size		A	B	Form/ shape	C	Form/ shape	D	Einbaulage/ mounting position
060	060 Pro	95mm	82mm	2	/	/	Ø4,3mm	Bodenbefestigung ground mounting
100	100 Pro	120mm	103mm	2	/	/	Ø4,3mm	Bodenbefestigung ground mounting
100	/	109mm	/	/	/	/	/	TOPJOB
160	/	137mm	75mm	2	/	/	/	Bodenbefestigung ground mounting TOPJOB
250/ 350	250/ 350 Pro	202mm	60mm	1	180mm	2	/	Bodenbefestigung ground mounting TOPJOB

Fehlende Maße können dem DXF entnommen werden
missing dimensions are provided in the DXF

Schutzvermerk ISO 16016 beachten. Refer to protection notice ISO 16016.

Maßstab: 1:2



Massblatt/ dimension sheet

Normschiene Abox

M-NS35-ABOX

A4

0 Freigabe

01.02.22

