

# Isolator Barriers

Binary output

Ex i field circuit

9175/10-16-11s Art. No. 160416



- Comprehensive portfolio to cater for all characteristics
- Two-channel variants reduce the amount of space required
- Can be used up to SIL 3 (IEC/EN 61508)
- For interface solenoid valves and LEDs

WebCode 9175A



9175 series binary outputs issue binary signals via one or two channels for the intrinsically safe operation of Ex i solenoid valves, indicator lamps or horns. The devices feature three-way galvanic separation. A wire-breakage and short-circuit monitoring system, which can be disconnected, directly monitors the state of the field circuit.

## Technical Data

### Explosion Protection

Application range (Zones)	2
Ex interface zone	0 1 2 20 21 22
IECEX gas certificate	IECEX BVS 10.0050 X
IECEX gas explosion protection	Ex nA nC [ia Ga] IIC T4 Gc
IECEX dust certificate	IECEX BVS 10.0050 X
IECEX dust explosion protection	[Ex ia Da] IIIC
ATEX gas certificate	DMT 03 ATEX E 043 X
ATEX gas explosion protection	⊕ II 3 (1) G Ex nA nC [ia Ga] IIC T4 Gc
ATEX dust certificate	DMT 03 ATEX E 043 X
ATEX dust explosion protection	⊕ II (1) D [Ex ia Da] IIIC
Certificate FMus	FM16US0122X
Certificate cFM	FM16CA0067X
Marking cFMus	Class I, Div. 2, Groups A,B,C,D; Class I, Zone 2, Group IIC AIS Class I,II,III, Div. 1, Groups A,B,C,D,E,F,G; Class I, Zone 0, [AEx ia]/[Ex ia] IIC T4 Mounting vert. at Ta = 70°C , or horizontal Ta = 60°C See Doc. 91 756 01 31 1
Certificate cULus	E81680V1S7
Marking cULus	providing intrinsically safe circuits for use in Class I,II,III, Groups A,B,C,D,E,F,G; See Doc. 91 756 01 31 3
EAC certificate	EAEU RU S-DE.HA91.B.00100/20
EAC gas explosion protection	⊕ 2 Ex nA nC [ia Ga] IIC T4 Gc X

### Explosion Protection

EAC dust explosion protection	[Ex ia Da] IIC X
Certificates	ATEX (BVS), Brazil (ULB), Canada (FM), EAC (ENDCE), IECEx (BVS), India (PESO), Korea (KTL), SIL (exida), USA (FM), USA (UL)
Ship approval	CCS, EU RO MR

### Safety Data

Max. voltage $U_o/V_{oc}$	27.6 V
Max. current $I_o$ (Ex ia)	110 mA
Max. current $I_o$ (Ex ib)	50 mA
Max. power $P_o$	760 mW
Max. permissible external capacitance $C_o/C_a$ for IIC	0.085 $\mu$ F
Max. permissible external capacitance $C_o/C_a$ for IIB	0.667 $\mu$ F
Max. permissible external inductance $L_o/L_a$ for IIC	1.2 mH
Max. permissible external inductance $L_o/L_a$ for IIB	9 mH
Internal capacitance $C_i$	1.1 nF
Internal inductance $L_i$	Negligible
Safety-related maximum voltage	253 V

### Functional Safety

SIL	3
HFT	0
SFF	94%
Lambda SU	166 FIT
Lambda DD	0 FIT
Lambda DU	9 FIT
$PFD_{avg}$ at $T_{proof}$ 1 year	4,25E-05
$PFD_{avg}$ at $T_{proof}$ 2 years	8,12E-05
$PFD_{avg}$ at $T_{proof}$ 5 years	1,97E-04

### Electrical Data

Number of channels	1
LFD relay	Yes

### Auxiliary Power

Auxiliary power	24 V DC
Auxiliary power voltage range	18 ... 31.2 V
Voltage range residual ripple	$\leq 3,6 V_{ss}$
Nominal current	80 mA
Power consumption	1.9 W
Power dissipation max.	1.4 W
Polarity reversal protection	Yes
Undervoltage monitoring	Yes
Operation indication	Green "PWR" LED

### Galvanic Isolation

Test voltage according to standard	IEC EN 60079-11
------------------------------------	-----------------

#### Galvanic Isolation

Galvanic isolation Ex i output to input	1,5 kV AC
Galvanic isolation Ex i output to auxiliary power	1,5 kV AC
Galvanic isolation Ex i output to fault message contact	1,5 kV AC
Test voltage according to standard	EN 50178
Fault message contact to auxiliary power	350 V AC
Input to auxiliary power	350 V AC
Input to input	350 V AC
Fault message contact to input	350 V AC

#### Input

Input	In accordance with EN 61131-2
Input voltage for ON	15 – 31.2 V
Input voltage for OFF	0 – 5 V
Control current	< 5 mA

#### Output

Output open-circuit voltage $U_a$	25 V
Max. output current $I_{a\max}$	35 mA
Output internal resistance $R_i$	250 $\Omega$
Output residual ripple	< 50 mV
Output switching frequency	$\leq$ 200 Hz
Switching delay ON/OFF	$\leq$ 1 ms
Switching delay ON/OFF	$\leq$ 1 ms
Switching state indication	Yellow LED "OUT"
Switching capacity fault message contact	30 V / 100 mA
Switch user adjustment line fault	Activated / deactivated
Indication of line fault	"LF" LED, red
Error detection wire breakage	> 15 k $\Omega$
Short circuit error detection	50 ... 90 $\Omega \pm 8 \Omega$ / 10 K
Test current	2.3 mA (at 100-ohm load)
Test current 2	0.72 mA (at 15-k $\Omega$ load)
Line fault and loss of power signalization	Contact (30 V / 100 mA) closed to ground in case of fault pac-Bus, floating contact (30 V / 100 mA)
Note	You can find a list of connectible Ex i solenoid valves on our homepage <a href="http://www.r-stahl.com">www.r-stahl.com</a> (WebCode 9175A)

Output characteristic 9175/.0-16-11;  
9176/.0-16-00

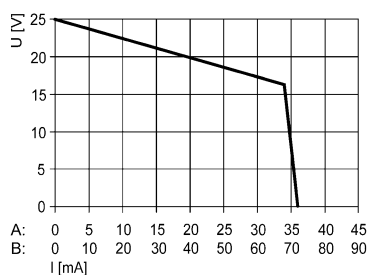

at  $U_N$ : -20 ... +60 °C

X-axis (I [mA])

A: characteristic curve each channel

B: characteristic curve channel 1 parallel channel 2 (only types 9175/20-...-...)

#### Ambient Conditions

Ambient temperature °C	-20 °C ... +70 °C (Single device) -20 °C ... +60 °C (Group assembly)
------------------------	---

# Isolator Barriers

Binary output

Ex i field circuit

9175/10-16-11s Art. No. 160416



## Ambient Conditions

Ambient temperature °F	-4 °F ... +158 °F (Single device) -4 °F ... +140 °F (Group assembly)
Storage temperature °C	-40 °C ... +80 °C
Storage temperature °F	-40 °F ... +176 °F
Max. relative humidity	95%
Use at the height of	< 2000 m
Electromagnetic compatibility	Tested to the following standards and regulations: EN 61326-1 Use in industrial environment; NAMUR NE 21

## Mechanical Data

Degree of protection (IP)	IP30
Terminal degree of protection (IP)	IP20
Fire resistance (UL 94)	V0
Enclosure material	Polyamide
Grid dimension	17.6 mm
Width	17.6 mm
Width inches	0.69 in
Height	114.5 mm
Height inches	4.51 in
Length	108 mm
Length inches	4.25 in
Weight	0.175 kg
Weight	0.39 lb

## Mounting / Installation

Mounting type	NS35/15, NS35/7.5 DIN rail
Mounting position	Vertical Horizontal
Connection type	Screw terminal
Conductor cross-section rigid min.	0.2 mm <sup>2</sup>
Conductor cross-section solid max.	2.5 mm <sup>2</sup>
Conductor cross-section flexible min.	0.2 mm <sup>2</sup>
Conductor cross-section flexible max.	2.5 mm <sup>2</sup>
Connection cross-section AWG	24 – 13

## Technical Drawings – Subject to Alterations

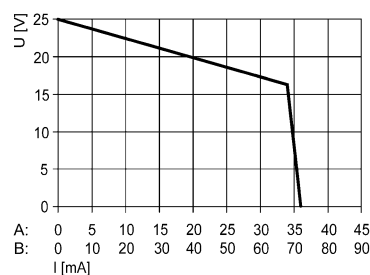
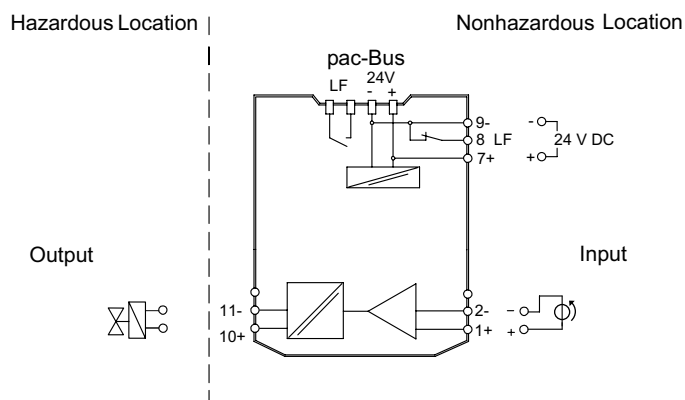

Output characteristic 9175/.0-16-11; 9176/.0-16-00

Connection Diagram 9175/10-16-11

# Isolator Barriers

Binary output

Ex i field circuit

9175/10-16-11s Art. No. 160416



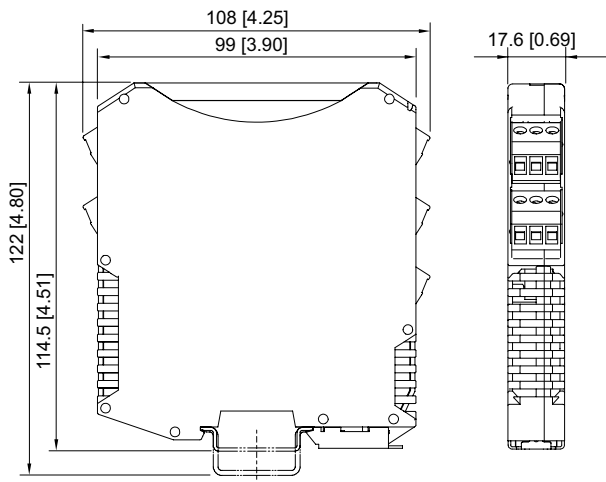

## Dimensional Drawings (All Dimensions in mm [inches]) – Subject to Alterations



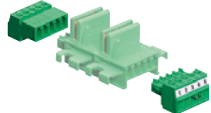

ISpac Series 9146, 9147, 9160, 9162, 9163, 9165, 9167, 9170, 9172, 9175, 9176, 9180, 9182, 9193, ISbus Series 9412 with screw terminal

## Accessories

Front cover		Art. No.
	for ISpac modules 91xx yellow, transparent Clear marking of the device for SIL applications. (Packaging unit: 10 pieces)	200914
pac-Bus		Art. No.
	Wiring auxiliary power and collective error message	160731
Terminal set for pac-Bus		Art. No.
	For the supply of 24 V DC auxiliary power via terminals (alternative to using the supply module 9193/21-11-11), with jumper for error message chain for ISpac module 91xx	160730

## Spare Parts

Screw terminal		Art. No.
	3-pole plug, screw connector thread: M3 stripping length: 7 mm color: green	112817
	3-pole plug, screw connector thread: M3 stripping length: 7 mm color: black	112816







# Isolator Barriers

Binary output

Ex i field circuit

9175/10-16-11s Art. No. 160416



	3-pole plug, screw connector thread: M3 stripping length: 7 mm color: blue	112818
<b>Screw terminal with test tap</b>		<b>Art. No.</b>
	3-pole plug with test tap, screw connector thread: M3 stripping length: 7 mm colour: black	113005
	3-pole plug with test tap, screw connector thread: M3 stripping length: 7 mm colour: blue	113004
<b>Spring clamp terminal</b>		<b>Art. No.</b>
	3-pole plug with test tap, spring clamp connection stripping length: 10 mm color: green	112825
	3-pole plug with test tap, spring clamp connection stripping length: 10 mm color: black	112824
	3-pole plug with test tap, spring clamp connection stripping length: 10 mm color: blue	112826

We reserve the right to make alterations to the technical data, dimensions, weights, designs and products available without notice. The illustrations cannot be considered binding.