

1x

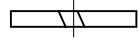

A8

8x

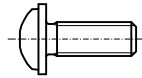

M6x12

8x

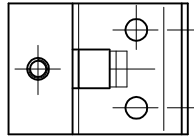

16x

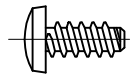

Bz 5,5x13

1x

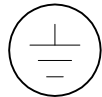

80x

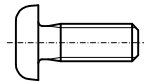

M5x12



TS

8609.100 8609.110

8609.120 8609.130

8609.165 8609.180

Raum für Verpackungsdatum
Area for date of packing
(MMJJTT / MMYDD)

2x

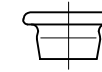

Ø9

2x

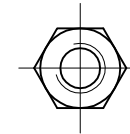

M8

1x

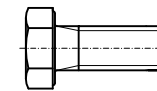

M8x30

1x

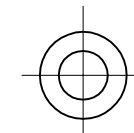

A8,4

1x

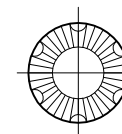

A8,2

Zchnng.-Nr. / No. of dwg. : A2313804TS

Versandbeutel-Nr. / No. of accessory bag : 277389

Lieferanten-Nr. / No. of supplier :

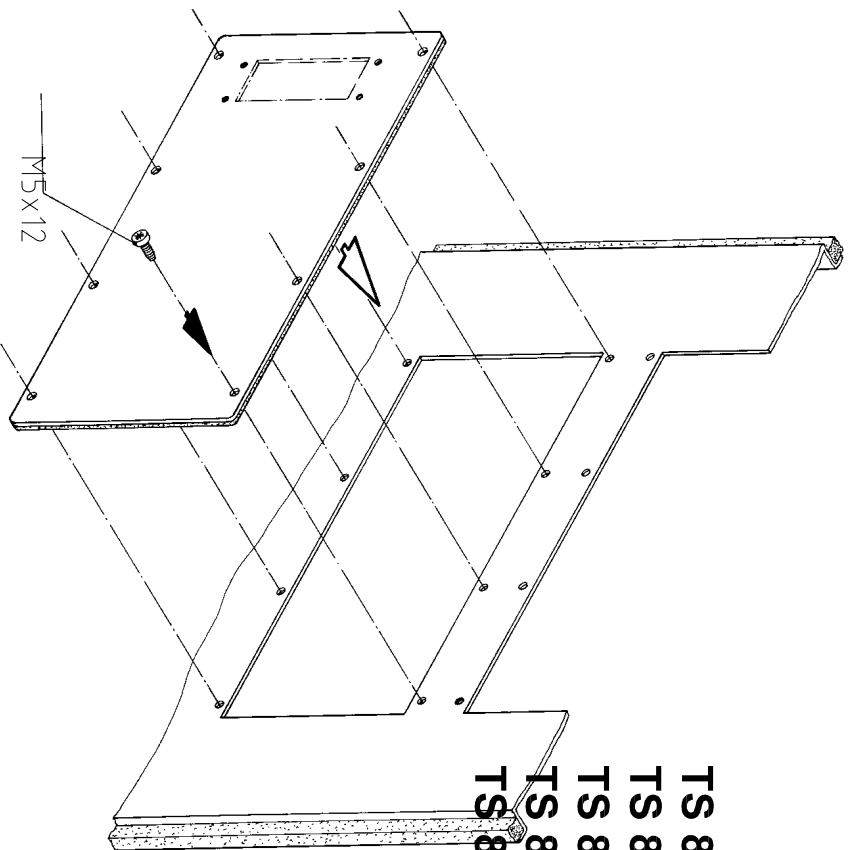

- TS 8609.140**
- TS 8609.150**
- TS 8609.160**
- TS 8609.170**
- TS 8609.190**

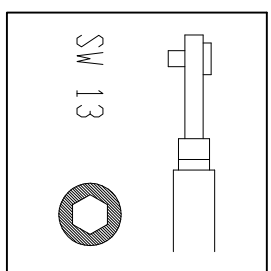
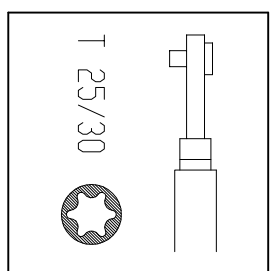

- H= 1400: 400
- H= 1600: 475
- H= 1800: 525
- H= 2000: 600
- H= 2200: 675

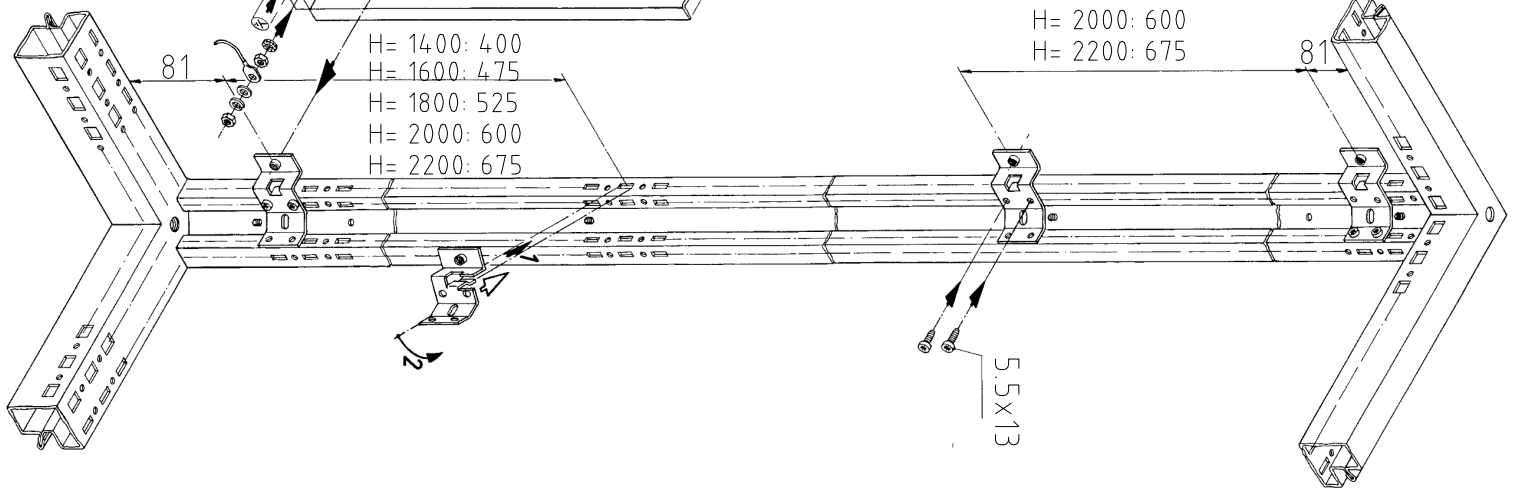
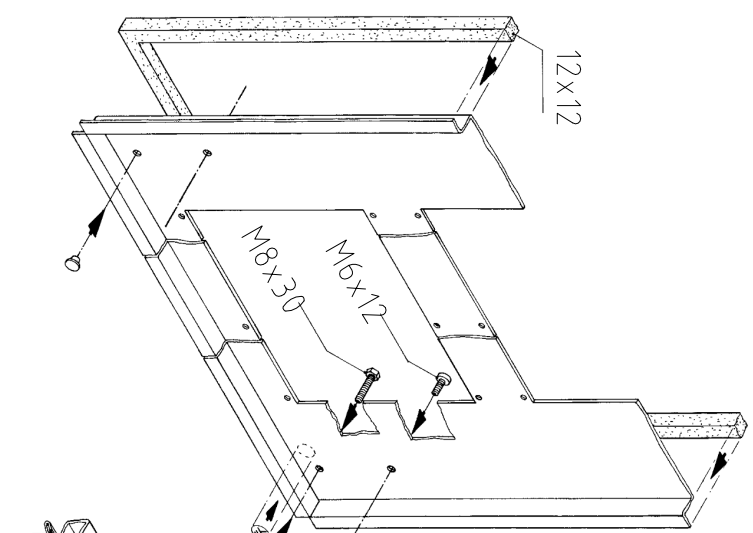

- H= 1400: 400
- H= 1600: 475
- H= 1800: 525
- H= 2000: 600
- H= 2200: 675