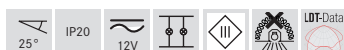
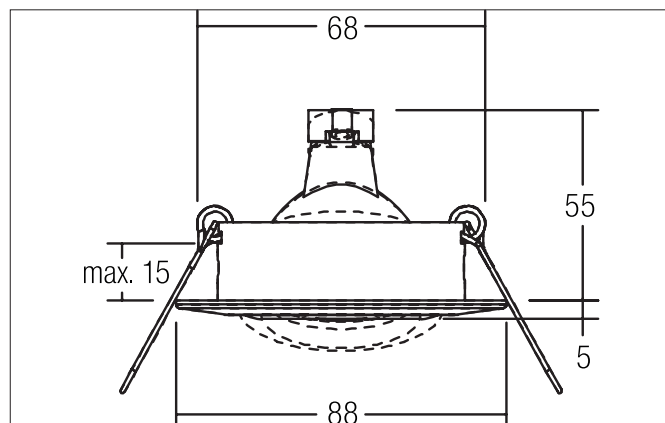

BREENA-R Recessed spot, GX5,3

Article no. 1963.15

Light.
For Generations.**Tender**

Recessed spot, GX5,3, nickel satin, Round. In a compact design, for installation in tool-less rapid assembly systems. Lamp holder: GX5.3, Mounting method: Recessed mounting, Place of installation: Ceiling-mounted, Material: Zinc casting / Aluminium casting, Degree of protection: according to DIN EN 60529 IP20, Protection class: (EN 61140) III, Voltage: 12V, Power: 50 W, Amount of light sources / fittings: 1 Qty, Adjustability: Pivoted, without control gear, Dimmable: Depending on type of control gear, Control: Depending on driver.

Product Benefits

- Recessed spotlight in round design made of solid cast zinc and cast aluminum for LED retrofit lamps with GX5.3 base (socket with 300 mm supply cable).
- Ceiling cut-out 68 mm, diameter 88 mm, installation depth 55 mm, IP20.
- Pivoting range 25°.
- Wide range of colors. Without visible snap ring.
- Classic, slightly curved design.
- Also available in the same look as GU10 version, as a switchable and dimmable set set (trailing edge).

BREENA-R Recessed spot, GX5,3

Article no. 1963.15

Light.
For Generations.

Article data	
Article no.	1963.15
GTIN	4250047764151
Series name	BREENA-R
Short description	Recessed spot, GX5,3
Material	Cast iron
Colour	Nickel
Type of surface	Matt
Shape	Round
Outer diameter	88 mm
Built-in diameter	68 mm
Installation depth	55 mm
Hight	5 mm
Scope of delivery	Incl. socket with supply line 300 mm, without snap ring
Weight	0.164 kg
Conformance	CE, UKCA

Operating technology of the luminaire	
System output	50 W
Voltage type	AC/DC
AC nominal voltage max	12 V
Frequency max	50 Hz
Lamp	For LED-retrofill lamp
Lamp holder	GX5.3
Protection class	III
Degree of protection	IP20
Dimmable	Depending on type of control gear
Control	Depending on driver
Bulb change possible	Yes

Mounting technology	
Mounting method	Recessed mounting
Place of installation	Ceiling-mounted
Adjustability	Pivoted
Swivel angle	25°
Max. ceiling thickness	15 mm
Further references	No mounting box No cover with thermal insulation material
Material cover	Without cover
Circlip	Without circlip

Packing data	
Gross weight	0.203 kg
Length of packaging	105 mm
Packaging width	90 mm
Packaging hight	55 mm
Disposal at end of life	This product must not be disposed of with household waste. You are obliged, to dispose of such electrical waste separately. By disposing of electrical waste and other old or defective electronics separately, you support recycling or other forms of re-use. In that way you help to take care and to avoid that harmful substances get into the environment.

BREENA-R Recessed spot, GX5,3

Article no. 1963.15







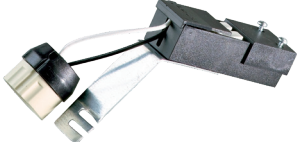

Light.
For Generations.

Compatible LED-modules						
Article no.	Power	Beam angle	Colour temperature	Luminous flux	Input	Hight LED-Modul
12925003	3 W	38°	2.700 K	290 lm	350 mA	40 mm
12926003	3 W	38°	3.000 K	310 lm	350 mA	40 mm
12925004	3 W	38°	4.000 K	340 lm	350 mA	40 mm
12923383	6 W	38°	2.700 K	600 lm	350 mA	32 mm
12923603	6 W	60°	2.700 K	570 lm	350 mA	32 mm
12924383	6 W	38°	3.000 K	680 lm	350 mA	32 mm
12924603	6 W	60°	3.000 K	660 lm	350 mA	32 mm
12924384	6 W	38°	3.500 K	680 lm	350 mA	32 mm
12924604	6 W	60°	3.500 K	660 lm	350 mA	32 mm
12923384	6 W	38°	4.000 K	720 lm	350 mA	32 mm
12923604	6 W	60°	4.000 K	700 lm	350 mA	32 mm
12920183	6 W	18°	3.000 K	640 lm	350 mA	31 mm
12920243	6 W	24°	3.000 K	690 lm	350 mA	31 mm
12920003	6 W	38°	3.000 K	670 lm	350 mA	31 mm
12920603	6 W	60°	3.000 K	620 lm	350 mA	31 mm
12920184	6 W	18°	4.000 K	685 lm	350 mA	31 mm
12920244	6 W	24°	4.000 K	740 lm	350 mA	31 mm
12920004	6 W	38°	4.000 K	720 lm	350 mA	31 mm
12920604	6 W	60°	4.000 K	660 lm	350 mA	31 mm
12963383	6 W	38°	3.000 K - 1.800 K	460 lm	350 mA	32 mm
12963603	6 W	60°	3.000 K - 1.800 K	430 lm	350 mA	32 mm
12953003	12 W	38°	2.700 K	1,120 lm	350 mA	70 mm
12954003	12 W	38°	3.000 K	1,210 lm	350 mA	70 mm
12954004	12 W	38°	3.500 K	1,240 lm	350 mA	70 mm
12953004	12 W	38°	4.000 K	1,250 lm	350 mA	70 mm
12965003	12 W	38°	3.000 K - 1.800 K	930 lm	350 mA	70 mm
12983003	12.5 W	38°	3.000 K	920 lm	350 mA	95 mm
12823003	8 W	60°	2.850 K	900 lm	24.00 V	50 mm
12843004	8 W	60°	2.000 K - 6.500 K	640 lm	24.00 V	50 mm
18438002	8 W	60°	RGB+WW	400 lm	24.00 V	50 mm
12929503	6.3 W	50°	2.700 K / 3.000 K / 4.000 K		350 mA	34 mm

BREENA-R Recessed spot, GX5,3

Article no. 1963.15











Light.
For Generations.

Accessories	
	Article no.: 5366 Bracket with socket GX5,3, with strain relief
	Article no.: 5358 Bracket with socket GZ10, with strain relief
	Article no.: 81204020 Reducing ring D 110 mm, for luminaire cut-out size 68 mm
	Article no.: 81204030 Reducing ring D 110 mm, for luminaire cut-out size 68 mm
	Article no.: 81204050 Reducing ring D 110 mm, for luminaire cut-out size 68 mm
	Article no.: 81204070 Reducing ring D 110 mm, for luminaire cut-out size 68 mm
	Article no.: 81204170 Reducing ring D 110 mm, for luminaire cut-out size 68 mm
	Article no.: 81204080 Reducing ring D 110 mm, for luminaire cut-out size 68 mm
	Article no.: 81204150 Reducing ring D 110 mm, for luminaire cut-out size 68 mm
	Article no.: 81205020 Reducing ring D 130 mm, for luminaire cut-out size 68 mm

BREENA-R Recessed spot, GX5,3

Article no. 1963.15



Light.
For Generations.

Accessories	
	Article no.: 8 1205030 Reducing ring D 130 mm, for luminaire cut-out size 68 mm
	Article no.: 8 1205050 Reducing ring D 130 mm, for luminaire cut-out size 68 mm
	Article no.: 8 1205070 Reducing ring D 130 mm, for luminaire cut-out size 68 mm
	Article no.: 8 1205170 Reducing ring D 130 mm, for luminaire cut-out size 68 mm
	Article no.: 8 1205080 Reducing ring D 130 mm, for luminaire cut-out size 68 mm
	Article no.: 8 1205150 Reducing ring D 130 mm, for luminaire cut-out size 68 mm
	Article no.: 8 1206020 Reducing ring D 145 mm, for luminaire cut-out size 68 mm
	Article no.: 8 1206030 Reducing ring D 145 mm, for luminaire cut-out size 68 mm
	Article no.: 8 1206050 Reducing ring D 145 mm, for luminaire cut-out size 68 mm
	Article no.: 8 1206070 Reducing ring D 145 mm, for luminaire cut-out size 68 mm
	Article no.: 8 1206170 Reducing ring D 145 mm, for luminaire cut-out size 68 mm

BREENA-R Recessed spot, GX5,3

Article no. 1963.15

Light.
For Generations.

Accessories	
	Article no.: 8 1206080 Reducing ring D 145 mm, for luminaire cut-out size 68 mm
	Article no.: 8 1206 150 Reducing ring D 145 mm, for luminaire cut-out size 68 mm