

Wallbox eM4 Twin reev ready

Controller+ with charging sockets

22 kW

The calibration law compliant Wallbox eM4 Twin is the future-proof and custom-fit charging solution for companies, the housing industry, car parks and private households. Two vehicles can be charged simultaneously at the ABL Type 2 charging sockets. Connected charging cables can be permanently locked/unlocked via the app.

Simple installation and operation

The cable entry is designed flexibly. The wallbox can be installed quickly and easily by just one person. The ABL Configuration App for Android and iOS makes configuration quick and straightforward. The intuitive user interface of the Wallbox eM4 Twin ensures simple operation thanks to visual and acoustic feedback.

Tailor-made solution

The Wallbox eM4 Twin is available as a Controller variant with integrated communication and control unit. The Extender variant makes it possible to cost-effectively add additional charge points via LAN or WLAN to form a group installation. Alternatively, both the Controller and the Extender variant can be operated independently. The static load management of a Controller/Extender group installation can optionally be enhanced with dynamic load management with the ABL Energy Meter accessory.

Quality and safety

The robust design and high-quality workmanship of the Wallbox eM4 Twin protect it from external influences. The wallbox comes pre-installed and ready for connection thanks to the integrated Type A RCCB and DC residual current detection. All ABL wallboxes are made in Germany and comply with the highest safety standards.





Product number 100000182

Further product advantages

- 
reev Backend/OCPP connection via LTE, LAN or WLAN

- 
Group installations with up to 30 charge points, scalable to a charging cluster with up to 100 charge points

- 
Standardised interfaces for integration into the reev Dashboard via OCPP Smart Charging and into external systems via Modbus TCP

- 
MID-compliant energy meter

- 
Calibration law compliant charging

- 
Plug & Charge ready (ISO15118)

- 
IP55 and IK10

ABL reev ready – eMobility hardware & software combined

ABL reev ready charging stations offer you ABL hardware with a SIM card already inserted and a reev ready pre-configuration. After commissioning the Controller variant, the Controller and associated Extender charging stations will have connectivity for two years. Activating the reev back-end within this period additionally allows use of the remote service free of charge. Users can activate the reev Dashboard with the reev ready Compact or Pro licence keys. The reev ready licence keys are available separately. One licence key is required per charge point.

reev Dashboard

Get more out of your ABL charging station: The reev software makes your ABL reev ready wallbox more efficient, automates processes and facilitates the control & management of charging processes – all in one place: the reev Dashboard. With the option of Compact or Pro, users can choose between two licences to meet their specific needs.

reev features

- Controlled access approval for authorised drivers
- Flexible user management & free tariff setting by creating and managing user groups
- Monitoring & management through clear display of site utilisation and charging processes
- Fully automated billing and invoicing on behalf of users
- reev app for drivers as an interface between the charging system operator and the driver
- Charge company cars at home and automatically transmit charging processes to the employer

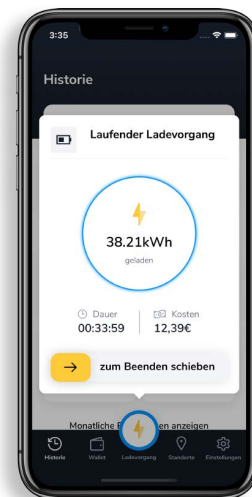
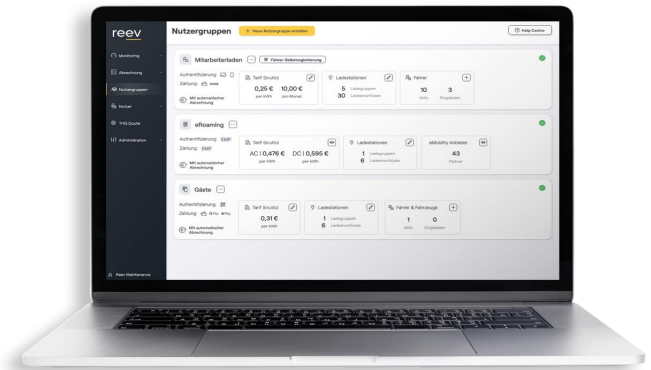

Why ABL reev ready?



ABL hardware with SIM card already inserted and a reev ready pre-configuration



Simple activation of the reev Dashboard through reev ready licence key



Out-of-the-box LTE connection for remote service (two years free of charge after commissioning)



Optimised and time-saving installation and onboarding of your charging infrastructure as well as comprehensive service for hardware and software

General information

Model	eM4 Twin
Product number	100000182
EAN number	4011721191430
Commodity code	85371091
Packaging unit (PU)	1 unit
Packaging (dimensions H×W×D)	581 × 503 × 230 mm
Items supplied	Wallbox, printed operating manual, printed instructions on "Calibration law compliant charging", 2 keys, installation kit, reev onboarding guide, reev RFID test key, 2 reev QR codes, LTE stick with SIM card, reev operator set, 2 reev RFID charging keys

Input / mains supply

External power supply	Supply cables up to a maximum of 10 mm ² or cable diameters ≤ 25 mm
Rated voltage	230 / 400 V (3-phase)
Rated current	32 A
Rated frequency	50 Hz
Upstream fuse	32 A (required onsite), C characteristic recommended
Connection	Direct connection to the terminal block

Output / vehicle connection

Connection system	Two lockable Type 2 charging sockets in acc. with IEC 62196-2
Output voltage	230 / 400 V
Max. charging current	32 A
Maximum charging power (3-phase)	2 × 11 kW or 1 × 22 kW
Maximum charging power (1-phase)	2 × 3.7 kW or 1 × 7.4 kW

Protection / integrated components

RCCB	RCCB, type A, 30 mA
DC fault current detection	Electronic, $I_{\Delta n \text{ d.c.}} \geq 6 \text{ mA}$
Energy meter	MID compliant
Load switching	Installation contactor, 4-pole, 40 A
Weld detection	No charging possible with welded contactors
Overcurrent protection	Integrated into firmware, disconnection at 120% after 10 seconds
Temperature monitoring	Internal, charging current reduction or shut down

Communication / interfaces

Operating status indicator	LED
Access control	RFID, QR code or smartphone app
Communication EV	In acc. with IEC 61851-1 Mode 3
Communication Controller/Extender	LAN, WLAN
Communication with reev Dashboard	LAN, WLAN, LTE (via supplied SIM card)
Supported protocols for communication	OCPP 1.6 (TLS 1.3), Modbus TCP
Load shedding / external release contact	Potential-free contact in accordance with VDE-AR-N 4100

Standards / directives

IEC 61851-1
IEC 61439-7 ACSEV
In acc. with MessEV Modul B
VDE-AR-N 4100

Operating conditions

Storage temperature	-30 to 75°C
Operating temperature	-25 to 40°C
Relative humidity	5 to 95%, no condensation
Class of protection	I
Overvoltage category	III
Degree of pollution	3
Degree of protection (housing)	IP55
Impact strength	IK10
Maximum elevation	≤ 2,000 m AMSL
Power dissipation	8 W

Housing

Type	Wall-mounted housing
Fixing type	Wall mounting using installation rail and installation kit
Material (housing / cover)	Plastic
Colour (housing / cover)	Black (similar to RAL 9011 / RAL 9017)
Locking mechanism	Two integrated lever locks
Dimensions (HxWxD)	516 × 428 × 145 mm (W: 395 mm without protrusions)
Weight (net)	Approx. 10.5 kg

Optional accessories

reev ready Compact licence key	100000188
reev ready Pro licence key	100000189
POLEM4 Twin mounting pole	100000192
POLE mounting pole Slim	For more information, see the data sheets.
ABL Energy Meter	100000193
Weather protection roof	WPR36
Cable storage holder with charging plug adapter	CABHOLD
Type 2 charging cable	CC3225 / CC3250 / CC3275 / CC3210: 32 A 480 V, length approx. 2.5 / 5 / 7.5 / 10 m
Type 2 to Type 1 adapter cable	LAKK2K1, 32 A 230 V, length approx. 4 m
RFID keyfobs	100000253
Individual lock (different locking circuits)	100000214, [...], 100000230

Dimensioned drawing

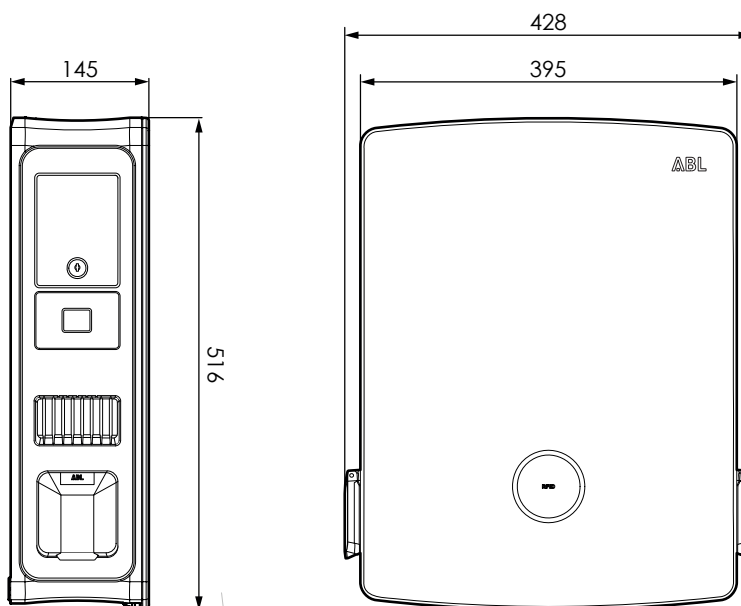

Subject to change: All performance characteristics, technical and other specifications are subject to change without prior notice.

Revision status ABL+reev_100000182_EN_b, 02/23

ABL GmbH • Albert-Büttner-Straße 11 • D-91207 Lauf / Pegnitz • Tel. +49 (0) 9123 188-0 • info@abl.de • www.abl.de • www.ablmobility.de

reev GmbH • Sandstraße 3 • 80335 Munich • Tel. +49 (0) 89 215 389 70 • info@reev.com • www.reev.com