

# Rittal – The System.

Faster – better – worldwide.

**Bodenblech, mehrteilig**  
**Gland plate, multi-piece**  
**Plaque passe-câble, en plusieurs parties**  
**Meerdelige bodemplaat**  
**Flerdelad golvplåt**  
**Lamiera di fondo, in più parti**  
**Chapas de suelo modulares**  
**グラウンドプレート、分割式**



DK 5502.510

DK 5502.530

DK 5502.540

DK 5502.550

DK 5502.560

DK 5502.570

**Montage- und Bedienungsanleitung**  
**Assembly and operating instructions**  
**Notice d'emploi et de montage**  
**Montage- en bedieningshandleiding**  
**Montage- och bruksanvisning**  
**Istruzioni di montaggio**  
**Instrucciones de montaje**  
**取扱説明書**

ENCLOSURES

POWER DISTRIBUTION

CLIMATE CONTROL

IT INFRASTRUCTURE

SOFTWARE & SERVICES



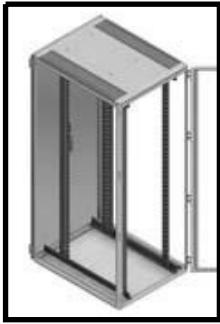

Best.-Nr. DK Model No. DK Référence DK		5502.510	5502.530	5502.540	5502.550	5502.560	5502.570
		W	800	800	600	800	600
D	600	800	1000	1000	1200	1200	
		3 x	4 x	5 x	5 x	5 x	5 x
		10 x	10 x	10 x	10 x	10 x	10 x
	Ø 7	5 x	5 x	5 x	5 x	5 x	5 x

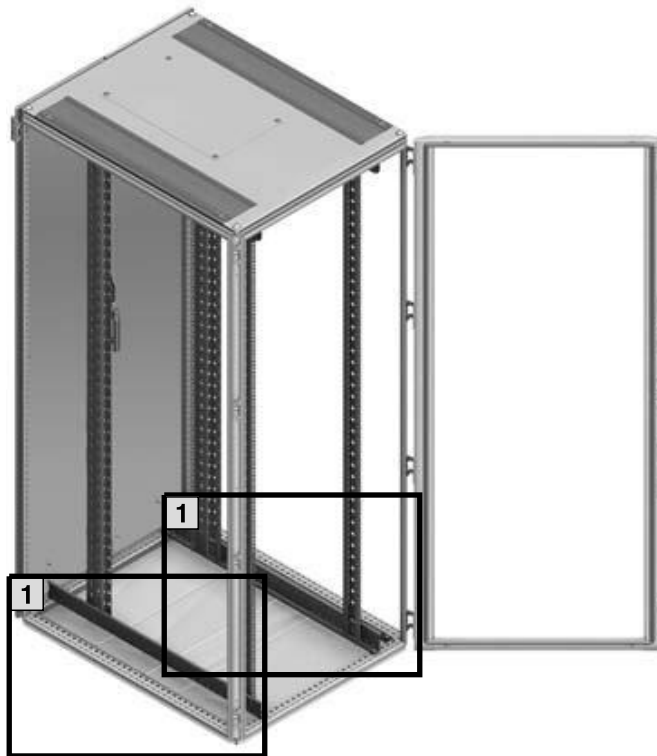



TX25 

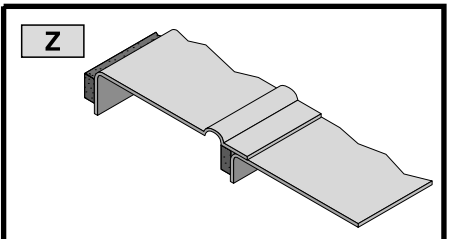
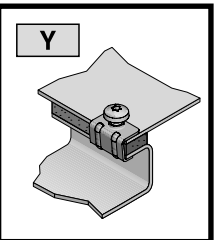
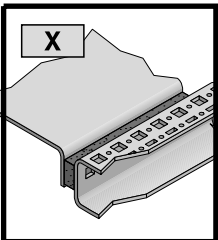
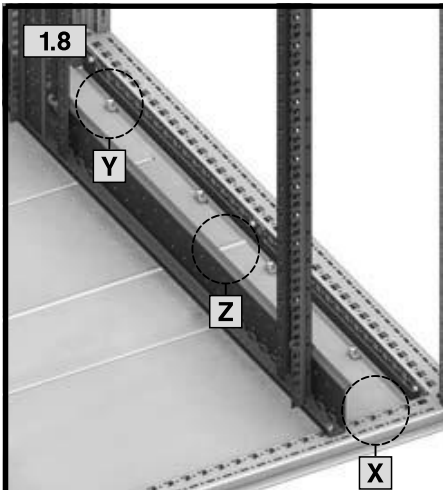
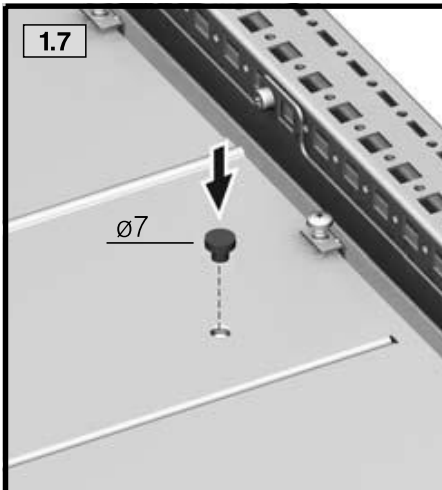
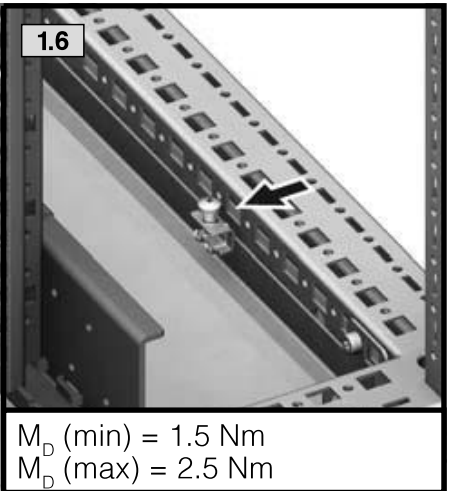
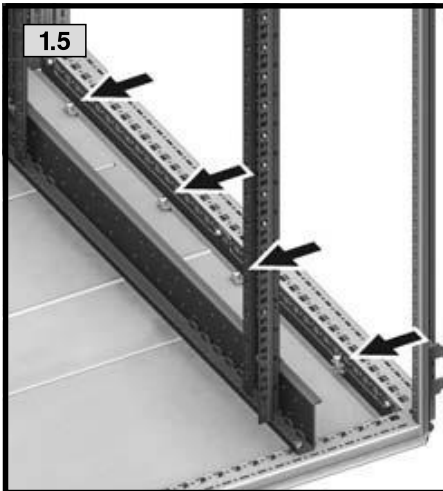
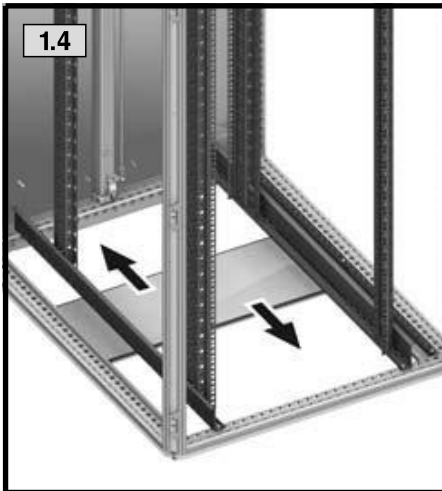
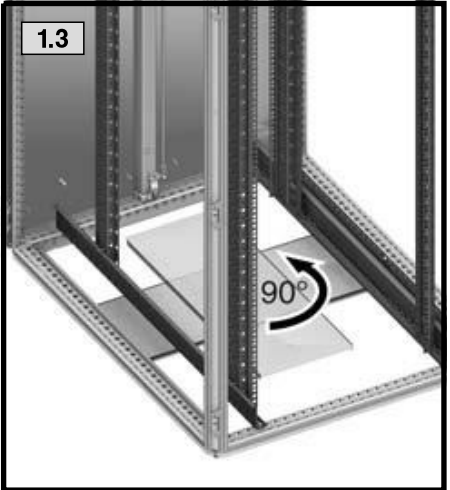
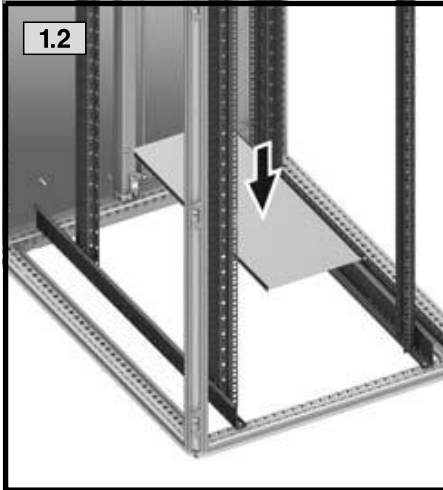
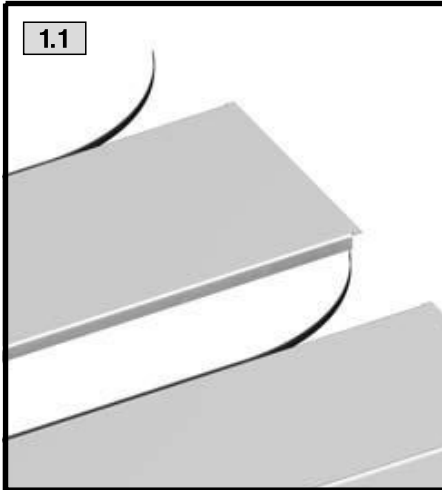
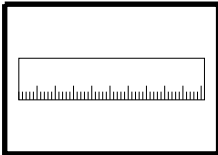
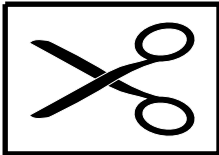
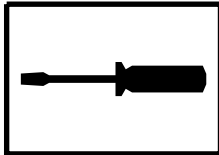

# Rittal – The System.

**Faster – better – worldwide.**

- Enclosures
- Power distribution
- Climate control
- IT infrastructure
- Software & services

04.2012/A4648001IT73

RITTAL GmbH & Co. KG  
Postfach 1662 · D-35726 Herborn  
Phone + 49(0)2772 505-0 · Fax + 49(0)2772 505-2319  
E-Mail: [info@rittal.de](mailto:info@rittal.de) · [www.rittal.de](http://www.rittal.de)

ENCLOSURES

POWER DISTRIBUTION

CLIMATE CONTROL

IT INFRASTRUCTURE

SOFTWARE & SERVICES

