

Datablad

Art. Nr. 96.030.0253.0

fordeler RST20I3V 3P1 V GL

RST20I3 3-pol Fordelerblok 250V/20A 1I/3O m. flange IP68 grå



Art. Nr.	96.030.0253.0
EAN	4015573734753
Ordre enhed	100 styk

Godkendelser

Specifikationer
Generelt

Nominal strøm	20 A
Nominal spænding	250 V
Nominal impuls spænding	4 kV
Forureningsgrad	3
låsbar	
Farve på kodning/kontaktindsats	lysegrå
Pol mærkning	L, N, PE

Model

Antal af indgange	1
Antal af udgange	3
Type fastgørelse	nej
Tæthedsklasse (IP)	IP66/68 (3m;2h) /IP69
fordeler type	fordelerblok

Materiale

Materiale kasse	Polyamid
Halogenfri	ja
Kontakt material	CuZn
brand belastning	0,222 kWh
Kontinuerlig temperatur, isolationsdele	100 °C
Overfladebehandling	forsølvet

Dimensioner

Længde	55,5 mm
Bredde	69,6 mm
Højde	31,3 mm

Tilbehør

Art. Nr.	Type	Beskrivelse
----------	------	-------------

05.564.4453.0	Blindprop for hanstik GL	RST20i3/2 blindprop, for afblinding af ubenyttet han stik, lysegrå
99.413.6205.2	Blindprop for hunstik GL	RST20i3/2 blindprop, for afblinding af ubenyttet hun stik, med snor, lysegrå
99.415.6205.2	Blindprop for hanstik GL	RST20i3/2 blindprop, for afblinding af ubenyttet han stik, med snor, lysegrå
Z5.564.4553.0	Blindprop for hunstik GL	RST20i3/2 blindprop, for afblinding af ubenyttet hun stik, lysegrå

drawn construction: 96.030.0153.0
 Gezeichnete Ausführung: 96.030.0153.0

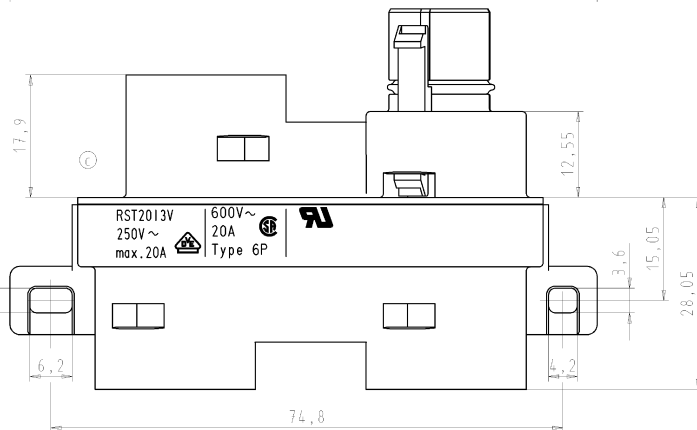
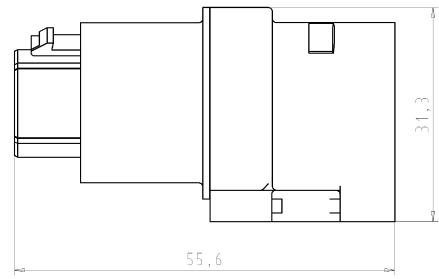
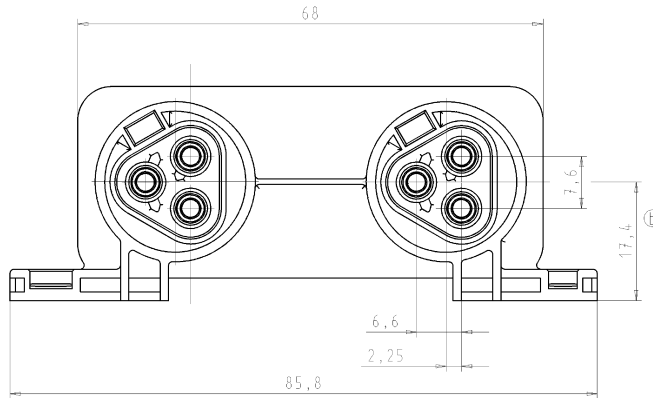

180°

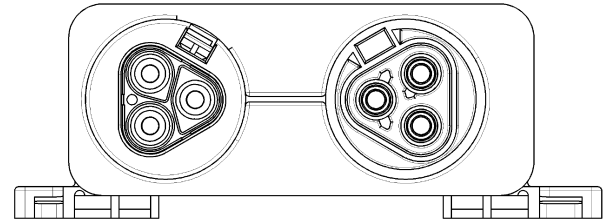

scale 1:1
 Maßstab 1:1

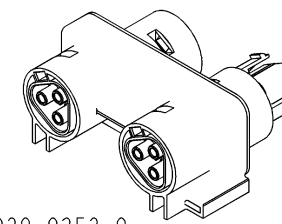
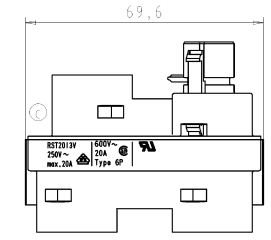

drawn construction: 96.030.0253.0
 Ausführung: 96.030.0253.0

scale 1:1
 Maßstab 1:1

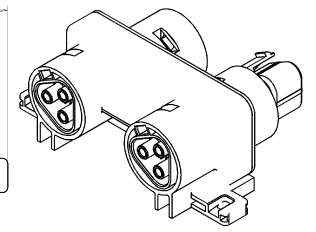
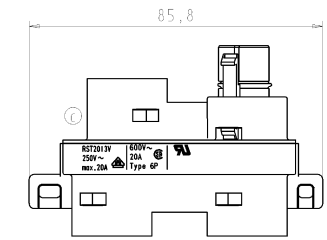

drawn construction: 96.030.0153.0
 Ausführung: 96.030.0153.0

packaging unit: per 100
 Verpackungseinheit: je 100 Stk.

Teile-Nr.	Type	Farbe	Variante
96.030.0153.1	RST2013V_3P1_F_V_SW	schwarz, ähnl. RAL 9005	mit Anschraubflansch
		black, similar to RAL 9005	with screwing flange
96.030.0153.0	RST2013V_3P1_F_V_GL	grau, ähnl. RAL 7032	mit Anschraubflansch
		grey, similar to RAL 7032	with screwing flange
96.030.0253.1	RST2013V_3P1_V_SW	schwarz, ähnl. RAL 9005	ohne Anschraubflansch
		black, similar to RAL 9005	without screwing flange
96.030.0253.0	RST2013V_3P1_V_GL	grau, ähnl. RAL 7032	ohne Anschraubflansch
		grey, similar to RAL 7032	without screwing flange

Erstellung nach: 2:1

2003 Tag Name

Entwerfer: 23.10. Kreis

Geplant: -

Freigegeben: -

Erstellt für: -

1. Verwendung: -

Bl. 1 von 1

Zeichnung Nr. 96.030.0153.0 01K c

Benennung

wieland
 Elektrotechnik
 Verbindungen

VERTEILER
 DISTRIBUTION BLOCK
 für RST2013/for RST2013

A
1
2
3
4
5
6
7
8
9
10
11
12
13
14
15
16
17
18
19
20
M1
M2
M3
L
G
I
1.1
2.1
1.1

9603002501K1_C020228 MPK_2009-04-30T10:16:05 1000