

1 2 3 4 5 6

A

B

C

D

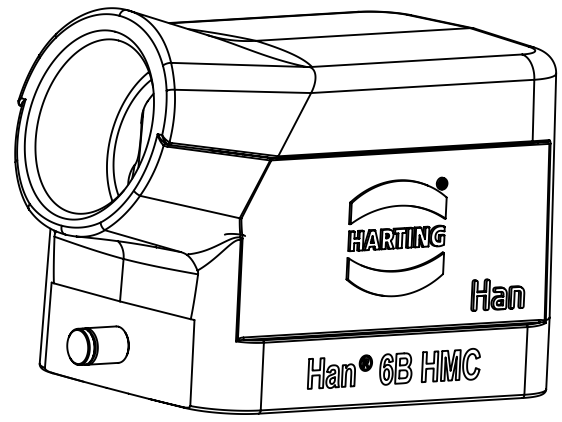
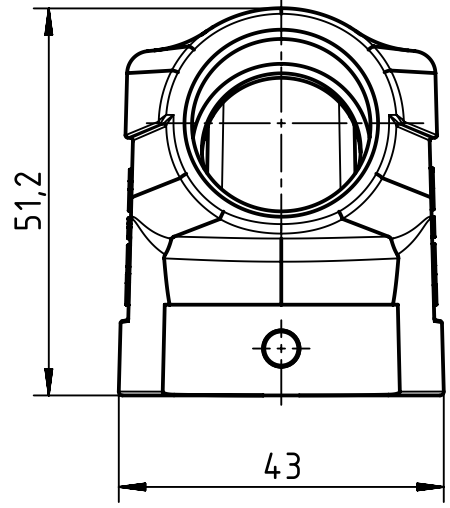
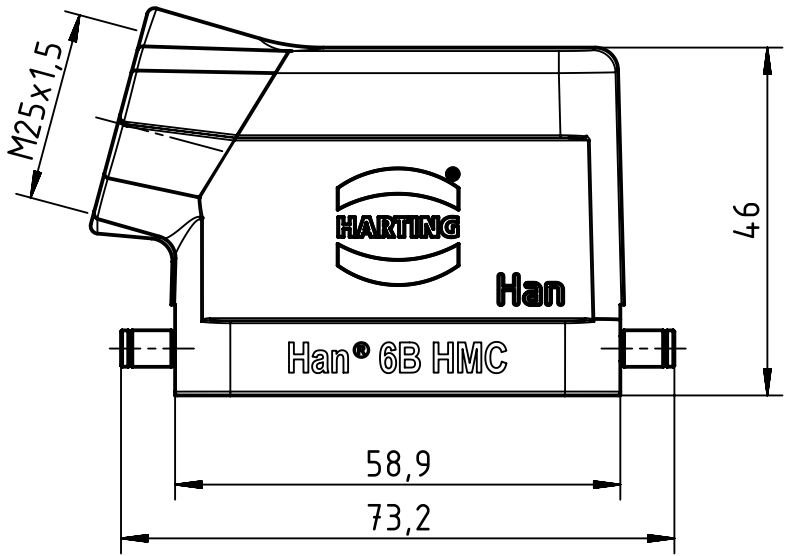

	All Dimensions in mm Original Size DIN A4		Scale 1:1	Free size tol.		Ref.	
	All rights reserved Department EL PD - DE		Created by RULLKOETTER	Inspected by SUNDERMEIER	Standardisation RUETERA	Date 2017-01-24	State Final Release
HARTING Electric GmbH & Co. KG D-32339 Espelkamp			Title Han 6B-HMC-gs-R-M25			Doc-Key / ECM-Nr. 100705833/UGD/004/A 500000113955	
			Type TB	Number 19 30 206 1541		Rev. A	Page 1/1