

## TR 0,4-2

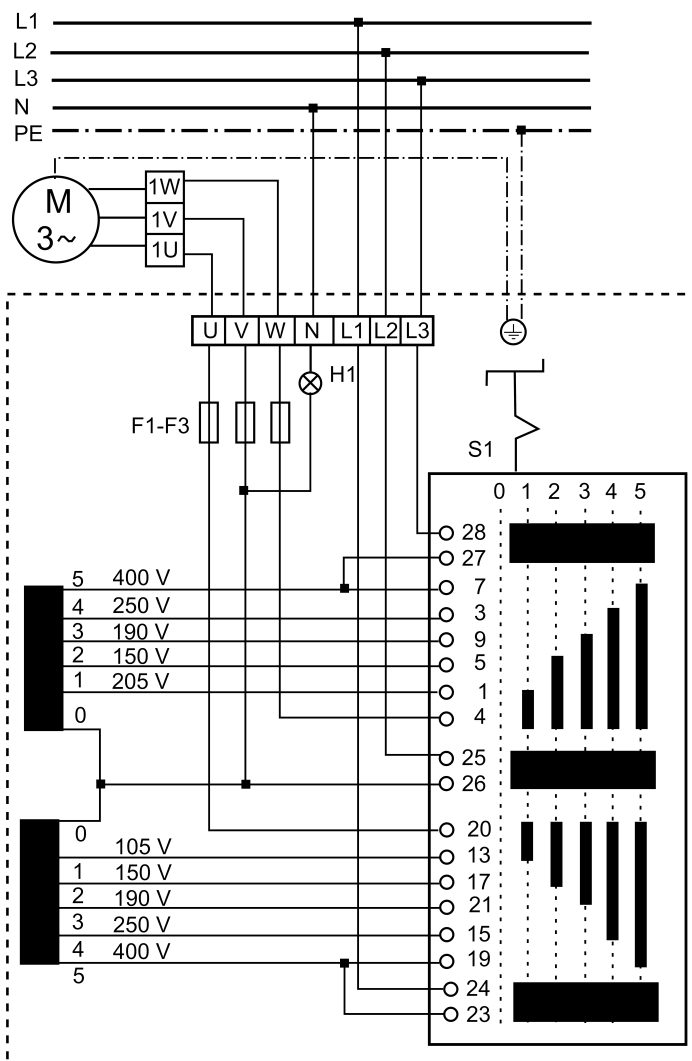

H1 - Betrieb (grün)  
 S1 - Schalter: Ein/Aus  
 M1 - Ventilatormotor (Drehstrom)