

FUZZY 080.1040.25.1/DALI

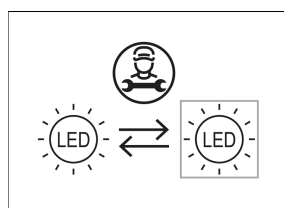

Farbe	Artikelnummer	EAN
schwarz	649088	4043544567604
silber	649089	4043544567611
weiß	649090	4043544567628

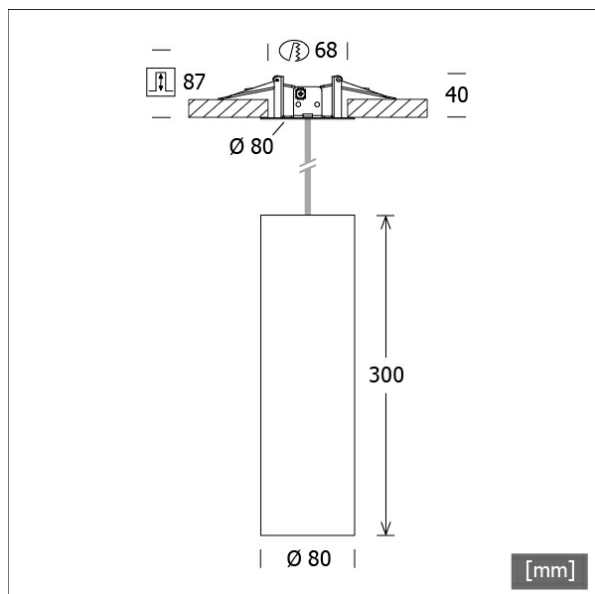

Beschreibung

- filigrane zylindrische Pendelleuchte
- Leuchte inklusive Lichteffektring klar als Standard
- Leuchte erweiterbar mit verschiedenen Lichteffektringen und Dekogläsern
- hohe Wartungsfreundlichkeit
- keine UV- und Wärmestrahlung
- Wärmemanagement mit Passivkühlung
- Spiegelreflektor aus Aluminium mit präziser symmetrischer Abstrahlcharakteristik für optimale Lichtausbeute und Entblendung
- Leuchtenzylinder aus Aluminium
- Kabelabhängung transparent (Länge: 1500 mm)
- Aluminium-Deckendose für werkzeuglose Montage mit Schnellspannfedern (automatische Anpassung der Deckenstärke)
- 5-polige Anschlussklemme
- Betriebsgerät (LED-Konverter DALI, dimmbar) integriert in Leuchte

Standardoptionen



Sonderoptionen



Lichttechnik / Normen

Leuchtmittel	LED Spot / CRI 80 / 4000 K
EPREL Lichtquellen	988919
Lebensdauer	L90 B50 50.000 h L80 B50 100.000 h L80 B20 50.000 h
Systemleistung	15.0 W
Leuchten-Lichtstrom	max. 1410 lm
Systemeffizienz	88.00 lm/W
Moduleffizienz	137.92 lm/W
UGR Klasse	≤28
Abstrahlwinkel	25°
Versorgungsspannung	220 - 240 V / 50 - 60 Hz
Schutzklasse	I
Schutzart	IP20

Abmessungen / Gewichte

Außendurchmesser	80 mm
Höhe	300 mm
Ausschnittsmaß (Ø)	68 mm
Deckenstärke	12.0 - 22.0 mm
Einbautiefe	87 mm
Nettogewicht	1.59 kg
Bruttogewicht	1.68 kg

FUZZY 080.1040.25.1/DALI

Fuzzy (FLIRZ 100.24, 1xLED 15W 840/4000K 1320lm 25 °)

C0/C180 cd / 1000 lm

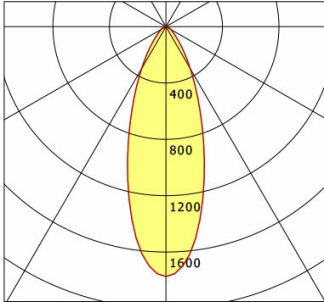

	C0	C90	C180	C270
0°	1774	1774	1774	1774
15°	1052	1052	1052	1052
30°	345	345	345	345
45°	99	99	99	99
60°	39	39	39	39
75°	17	17	17	17
90°	0	0	0	0
cd / 1000 lm				

Offset [m] Cone width [m] Illuminance [lx]

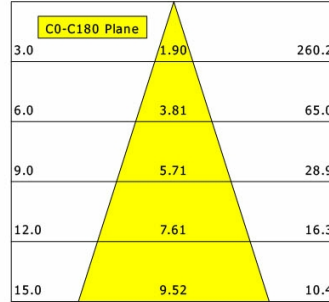

η	LED
Efficiency	88 lm/W
Direct/Indirect	↓ 100% / ↑ 0%
System Power	15 W
UGR	X=4H, Y=8H
Reflection factors	70/50/20
UGR C0/C180	26.7
UGR C90/C270	26.7
CIE Flux Codes	84 95 99 100 100
Ra/CRI	>80

LTS

Fuzzy (FLIRZ 100.25, 1xLED 15W 840/4000K 1360lm 25 °)

C0/C180 cd / 1000 lm

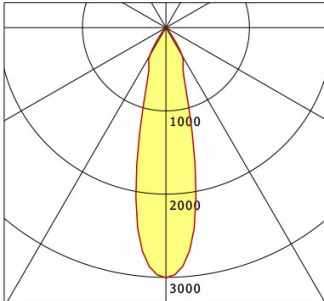

	C0	C90	C180	C270
0°	3002	3002	3002	3002
15°	1136	1136	1136	1136
30°	389	389	389	389
45°	44	44	44	44
60°	23	23	23	23
75°	8	8	8	8
90°	0	0	0	0
cd / 1000 lm				

Offset [m] Cone width [m] Illuminance [lx]

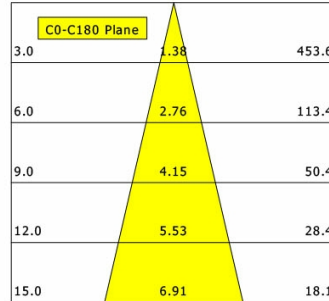

η	LED
Efficiency	91 lm/W
Direct/Indirect	↓ 100% / ↑ 0%
System Power	15 W
UGR	X=4H, Y=8H
Reflection factors	70/50/20
UGR C0/C180	22.9
UGR C90/C270	22.9
CIE Flux Codes	91 97 99 100 100
Ra/CRI	>80

LTS

Fuzzy (FLIRZ 100.05, 1xLED 15W 840/4000K 1410lm 25 °)

C0/C180 cd / 1000 lm

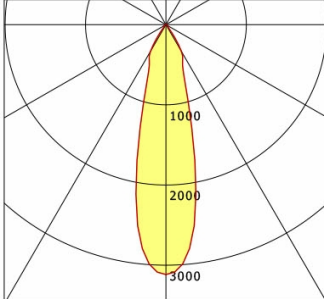

	C0	C90	C180	C270
0°	3116	3116	3116	3116
15°	1159	1159	1159	1159
30°	385	385	385	385
45°	34	34	34	34
60°	21	21	21	21
75°	9	9	9	9
90°	0	0	0	0
cd / 1000 lm				

Offset [m] Cone width [m] Illuminance [lx]

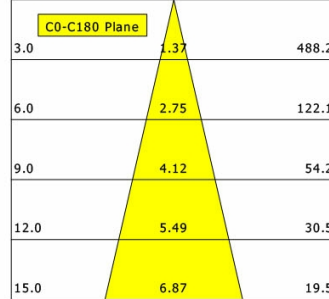

η	LED
Efficiency	94 lm/W
Direct/Indirect	↓ 100% / ↑ 0%
System Power	15 W
UGR	X=4H, Y=8H
Reflection factors	70/50/20
UGR C0/C180	23.1
UGR C90/C270	23.1
CIE Flux Codes	93 97 99 100 100
Ra/CRI	>80

LTS

FUZZY 080.1040.25.1/DALI

Zubehör



FLIRZ 100.04
Lichteffektring opal



FLIRZ 100.05
Lichteffektring klar



FLIRZ 100.16
Lichteffektring rot transluzent



FLIRZ 100.17
Lichteffektring gelb transluzent



FLIRZ 100.18
Lichteffektring blau transluzent



FLIRZ 100.19
Lichteffektring orange transluzent

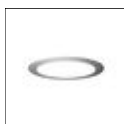

FLIRZ 100.24
Dekoglas opal



FLIRZ 100.25
Dekoglas klar



LAB 60
3-Phasen-Einbau-Monopoint mit Busoption



LAB 60 A
3-Phasen-Anbau-Monopoint mit Busoption