

SCHALTBILDER

EZS 30/2 B

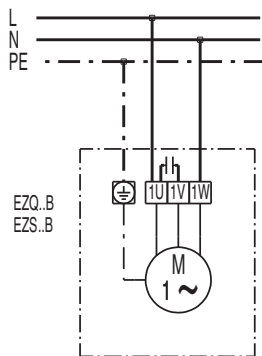
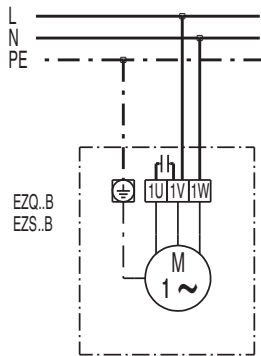

SCHALTBILDER

EZS 30/2 B

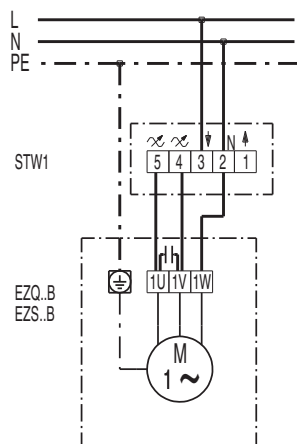
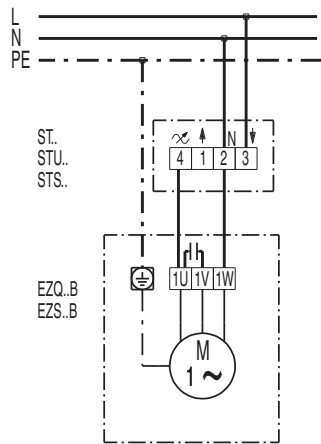

SCHALTBILDER

EZS 30/2 B

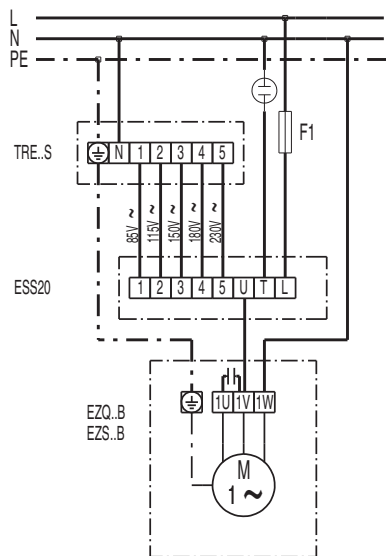
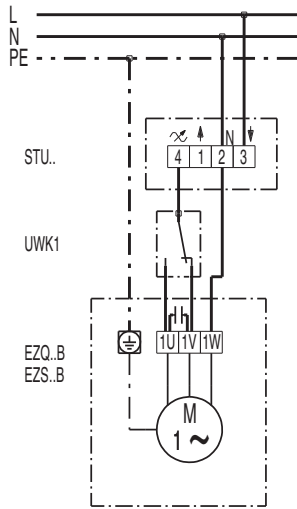

SCHALTBILDER

EZS 30/2 B

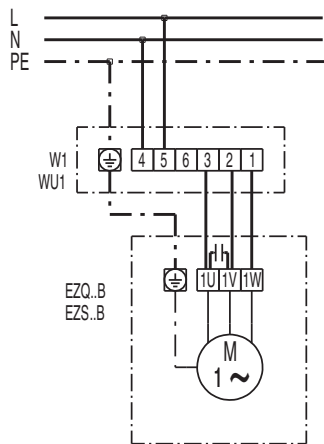
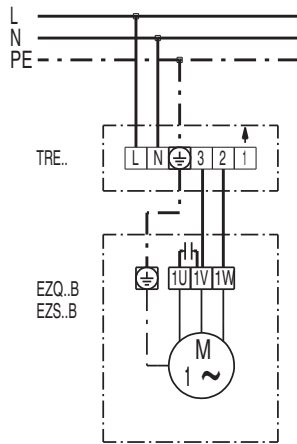

SCHALTBILDER

EZS 30/2 B

