

EZS 20/2 B

EZQ / EZS..B Rechtslauf

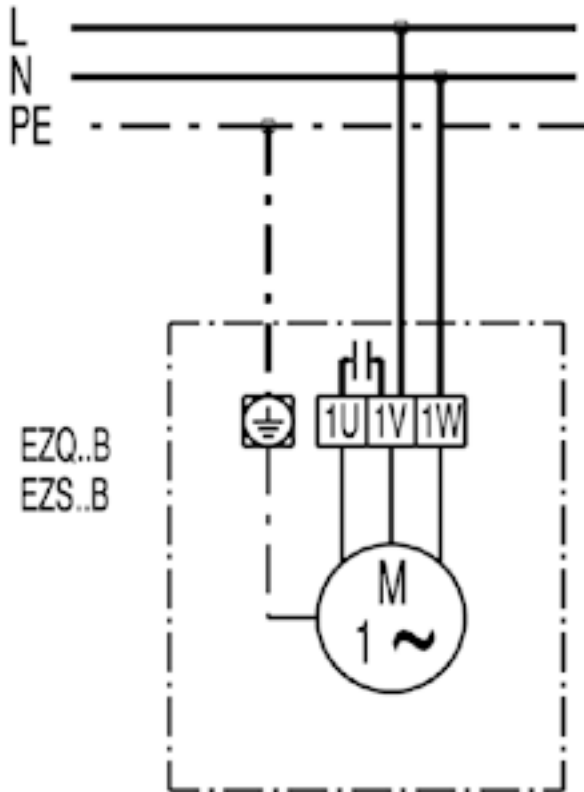

## EZS 20/2 B

### EZQ / EZS..B Linkslauf

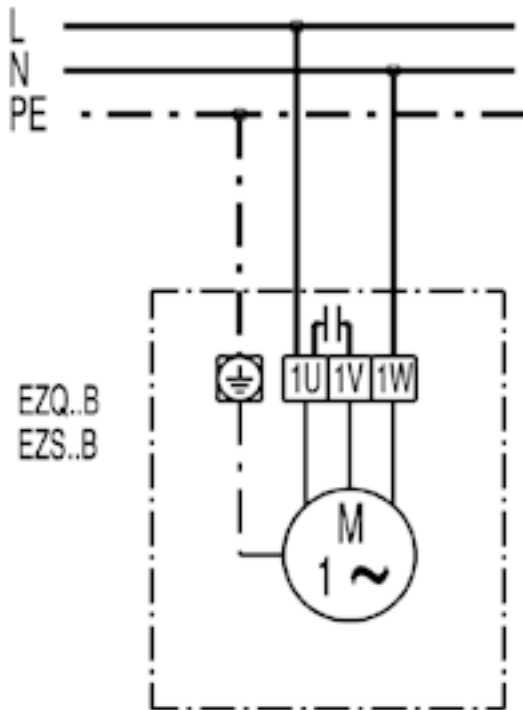

### EZQ / EZS..B mit Drehzahlsteller ST / STU / STS Linkslauf

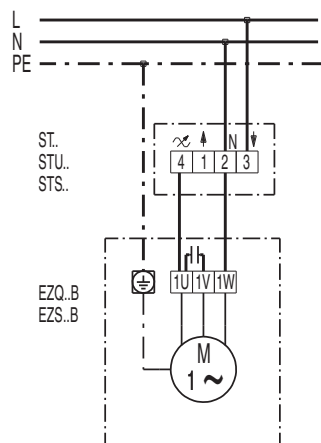

**EZQ / EZS..B mit Drehzahlsteller STW1**

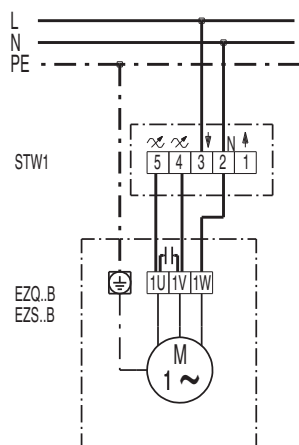

**EZQ / EZS..B mit Wendeswitcher UKW 1 und Drehzahlsteller STU..**

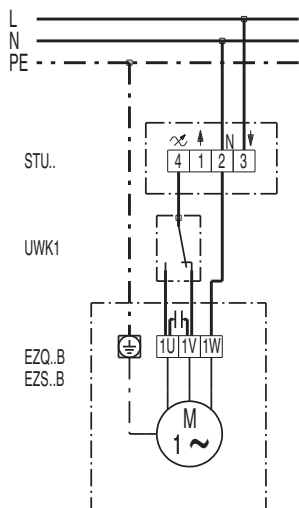

**EZQ / EZS..B mit 5-Stufentransformator TRE..S / Tr..S und 5-Stufenschalter ESS20**

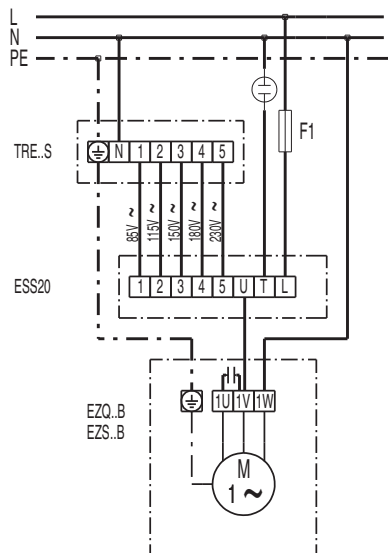

**EZQ / EZS..B mit 5-Stufentransformator TRE..**

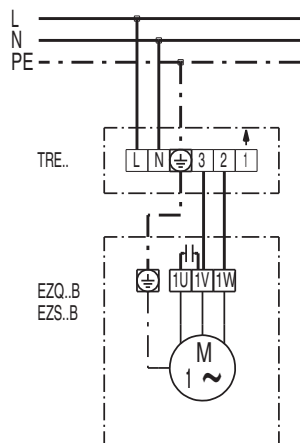

## EZS 20/2 B

### EZQ / EZS..B mit Wendeschalter W1 / WU1

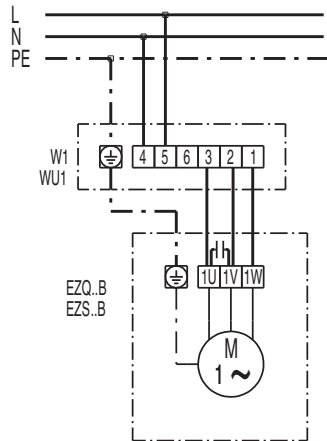

### EZQ / EZS..B mit Wendeschalter FS 7

