

6036/1225-450-0651-11 Art. No. 274188

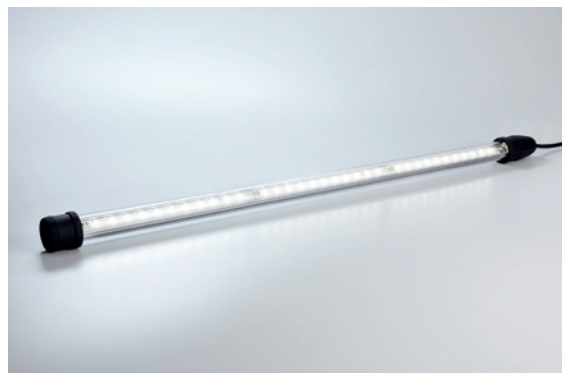

- Degree of protection IP66 and IP68
- Type of protection Ex d
- Vibration-resistant, lightweight, robust (impact strength rating of IK10) and maintenance-free
- Many light fittings can be connected to single miniature circuit breaker due to incredibly low start-up current

WebCode **6036A**



The 6036 series compact LED tubular light fitting is ideal for general lighting applications and for use as machine lighting, even in relatively inaccessible places with very little space. This light boasts a long service life of up to 100,000 hours thanks to its use of energy-efficient LED technology, coupled with electronics that have been developed in-house by R. STAHL. Due to its robust construction, it can withstand extreme temperatures of between -55 °C and +60 °C.

### Technical Data

#### Explosion Protection

Application range (zones)	1 2 21 22
IECEX gas certificate	IECEX EPS 13.0027
IECEX gas explosion protection	Ex db op is IIC T4 Gb
IECEX dust certificate	IECEX EPS 13.0027
IECEX dust explosion protection	Ex tb IIIC T100 °C Db
ATEX gas certificate	EPS 13 ATEX 1 597
ATEX gas explosion protection	Ex II 2 G Ex db op is IIC T4 Gb
ATEX dust certificate	EPS 13 ATEX 1 597
ATEX dust explosion protection	Ex II 2 D Ex tb IIIC T100 °C Db
Certificates	ATEX (BVIS), IECEX (BVIS)
Ship approval	DNVGL

#### Electrical Data

Rated operational voltage AC	220 – 240 V
Rated operational voltage DC	209 – 240 V
Nominal current	0.13 – 0.13 A
Power factor	≥ 0.95
Frequency range	50 – 60 Hz

#### Lighting Data

Number of lamps	1
Lamp wattage	25 W
Lamp	Single-row LED
Light colour	Neutral white
Luminaire efficacy	112 lm/W

6036/1225-450-0651-11 Art. No. 274188

### Lighting Data

Luminous flux	2847 lm
Colour rendering	≥ 80
Colour temperature	5000 K
Note	Values apply to T <sub>a</sub> = +25 °C

### Ambient Conditions

Ambient temperature	-40 °C ... +60 °C
Storage temperature	-40 °C ... +70 °C

### Mechanical Data

Version	Size 2
Degree of protection (IP)	IP66 / IP67
Degree of protection IP (IEC 60598)	IP66 / IP68 (10 m / 60 min)
Class	II (double insulated)
Enclosure material	Polycarbonate
Diffuser	With diffuser
Silicon free	Silicone free
Pipe material	Polycarbonate
Type of connection cable	(N)SSHÖU 2x1.5
Cable length	5 m
Design size	2
Width	54 mm
Height	54 mm
Length	762 mm
Diameter	54 mm
Impact strength (IEC 62262)	IK10
Weight	1.65 kg
Weight	3.64 lb

### Components

Ballast	LED, CSS
Wire guard	No

6036/1225-450-0651-11 Art. No. 274188

Technical Drawings – Subject to Alterations

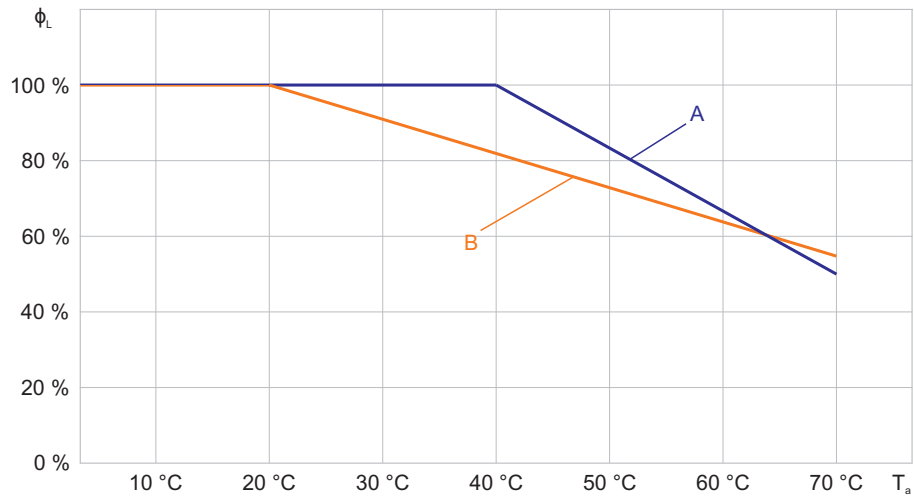

Luminous flux decrease at ambient temperature

A: Size 1 (110 ... 240 V)

B: Size 1 (24 ... 48 V)

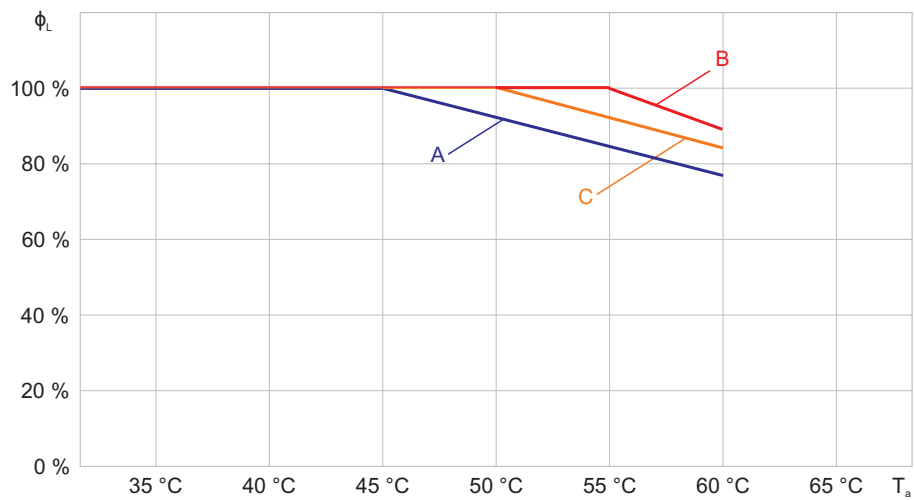

Luminous flux decrease at ambient temperature

A: Size 2

B: Size 3

C: Size 4

6036/1225-450-0651-11 Art. No. 274188

### Light Distribution Curves

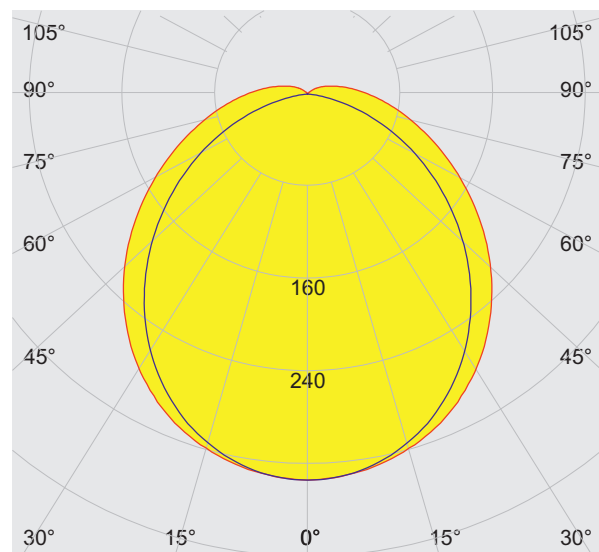

cd/klm 100%  
 — C0 - C180 — C90 - C270  
 with diffuser

### Dimensional Drawings (All Dimensions in mm [inches]) – Subject to Alterations

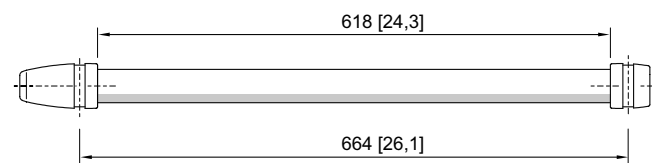
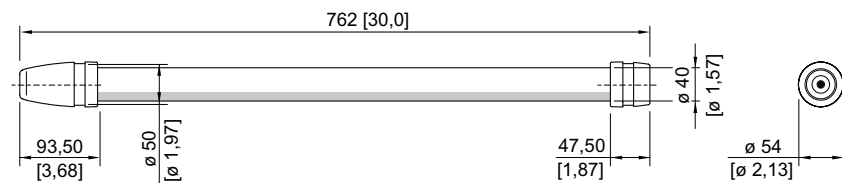

Design size 2

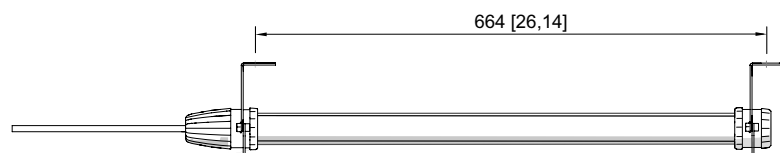

Luminaire with mounting bracket for a surface



Luminaire with mounting bracket for a surface and mounting plate

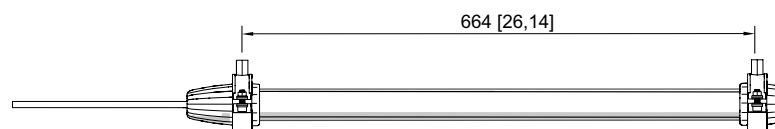

Luminaire with mounting bracket for a thread

6036/1225-450-0651-11 Art. No. 274188

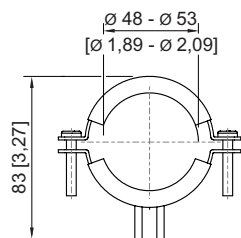
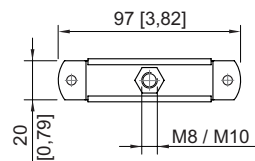

Mounting bracket for a thread

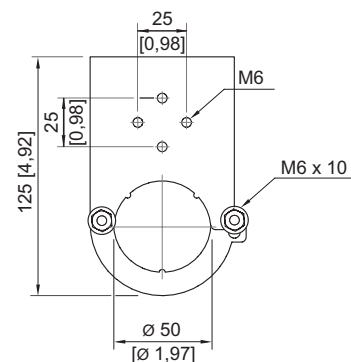
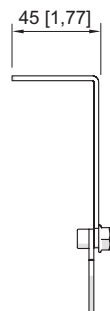
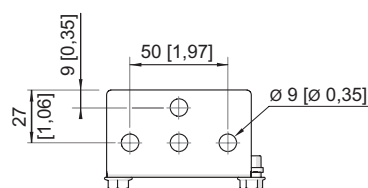

Mounting bracket for surfaces

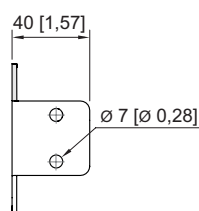
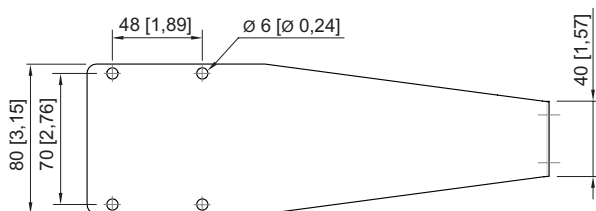

Mounting plate

## Accessories

### Plug

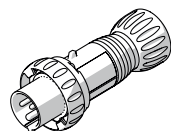



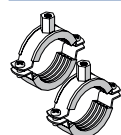

	Art. No.
8573/12-200 2 pins, 20 ... 25 V, 50 / 60 Hz, 16 A	243197
8573/12-210 2 pins, 20 ... 25 V, DC, 16 A	243203
8573/12-300 3 pins, 20 ... 25 V, 50 / 60 Hz, 16 A	243190
8573/12-312 3 pins, 40 ... 50 V, 50 / 60 Hz, 16 A	243195
8570/12-304 3 pins, 100 ... 130 V AC, 50 / 60 Hz, 16 A	257778
8570/12-306 3 pins, 200 ... 250 V AC, 50 / 60 Hz, 16 A	257780

### Mounting bracket

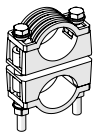
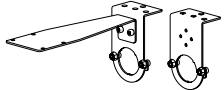
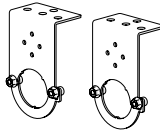

	Art. No.
Mounting bracket made of galvanised sheet steel to screw onto thread M8 or M10 (2 pieces)	227256
Mounting bracket made of stainless steel V4A to screw onto thread M8 or M10 (2 pieces)	227257

6036/1225-450-0651-11 Art. No. 274188

	Double mounting bracket made of plastic for mounting of pipes with a diameter of 45 ... 55 mm (Screws and nuts made of stainless steel V2A) (2 pieces)	254932
	Set of mounting plate Art. no. 254494 and mounting bracket Art. no. 252940	248100
	Mounting bracket made of stainless steel V4A for fastening on surfaces (2 pieces)	252940
	Mounting bracket made from galvanised sheet steel (x 2 units); for design size 1	120535
	Mounting plate made of stainless steel V4A for terminal box Ex e Series 8010 (for example Art. No. 130724) for fastening on mounting bracket Art. No. 252940	254494
<b>Mounting bracket and magnet</b>		<b>Art. No.</b>
	Mounting bracket made from galvanised sheet steel with magnetic base (x 2 units); for design size 1	120536

We reserve the right to make alterations to the technical data, dimensions, weights, designs and products available without notice. The illustrations cannot be considered binding.