

Remote I/O

Remote I/O IS1+ Temperature input module

For Zone 1 Ex i

9482/32-08-11 Art. No. 217643



- 8 channels for resistance temperature detectors, potentiometers, thermocouples, mV sensors and joysticks
- Intrinsically Safe inputs with line fault monitoring and LED error indication per channel
- Module hot swap in Zone 1 and Class I, Div. 1

WebCode 9482A



The series 9482 temperature input module for Zone 1 and Class I, Div. 1 has eight channels for the I.S. operation of resistance temperature detectors with two-, three- or four-wire connection and thermocouples. Sensors that comply with DIN, IEC and GOST are supported as well as resistance transmitters up to 10 kΩ and also joysticks for rapid four-channel operation. Earthed thermocouples can be connected. Cold junction compensation can be performed internally or externally.

Technical Data

Explosion Protection

Application range (zones)	1 2
Application range (Zone) note	A suitable enclosure in accordance with the area of application must be used. Refer to the operating instructions.
Ex interface zone	0 1 2 20 21 22
IECEX gas certificate	IECEX DEK 13.0046X
IECEX gas explosion protection	Ex ia [ia Ga] IIC T4 Gb
IECEX dust certificate	IECEX DEK 13.0046X
IECEX dust explosion protection	[Ex ia Da] IIIC
ATEX gas certificate	DEKRA 13 ATEX 0140 X
ATEX gas explosion protection	Ex II 2 (1) G Ex ia [ia Ga] IIC T4 Gb
ATEX dust certificate	DEKRA 13 ATEX 0140 X
ATEX dust explosion protection	Ex II (1) D [Ex ia Da] IIIC
Certificate FMus	FM17US0332X
Certificate cFM	FM16CA0134X
Marking cFMus	IS, Class I, Div. 1, Groups A,B,C,D; Class I, Zone 1, AEx/Ex ia [ia] IIC AIS Class I,II,III, Div. 1, Groups A,B,C,D,E,F,G; T4 at Ta = 75°C See Doc. 9482 6 031 001 1
EAC certificate	TS RU S-DE.GB04.B.00448
EAC gas explosion protection	Ex 1 Ex ia [ia Ga] IIC T4 Gb
EAC dust explosion protection	Ex [Ex ia Da] IIIC

Remote I/O

Remote I/O IS1+ Temperature input module

For Zone 1 Ex i

9482/32-08-11 Art. No. 217643



Explosion Protection

Certificates	ATEX (DEK), Brazil (ULB), Canada (FM), EAC (STV), IECEx (DEK), India (PESO), Korea (KTL), Russia (Meteorological certificate), USA (FM)
Ship approval	EU RO MR
Installation	Zones 1, 2 and in the safe area
Further information	see operating instructions and certificate

Safety Data

Internal capacitance C_i	Negligible
Internal inductance L_i	Negligible

Notes
 For proof of intrinsic safety, the safety data must be used in accordance with the combination of connections and the corresponding sensor.
 For further information and combination, see operating instructions.

Combination of connection 1								
Sensors	up to 8 resistance temperature detectors or resistance transmitters							
Note	no thermocouple / mV sensor connected							
Installation type	insulated							
Max. output voltage U_o ext	6.42 V							
Max. current I_o	2-wire	3-wire	4-wire					
	6.5 mA	7.8 mA	9.8 mA					
Max. power P_o	2-wire	3-wire	4-wire					
	10.5 mW	12.5 mW	15.7 mW					
Max. connectable inductance L_o /capacitance C_o								
IIC	L_o [mH]	100	50	20	2	0.2	0.02	0.002
	C_o [μ F]	1.1	1.2	1.4	2.0	3.2	7.0	25
IIB/IIIC	L_o [mH]	100	50	20	2	0.2	0.02	0.002
	C_o [μ F]	5	6.3	7.1	10	19	51	570
Combination of connection 2								
Sensors	up to 8 thermocouples or mV sensors							
Note	can be connected simultaneously to resistance temperature detector and resistance transmitter and/or external reference junction							
Installation type	earthed							
Reference junction	internal/external							
Thermocouple/mV sensor								
Max. output voltage U_o ext	12.92 V							
Max. current I_o	25.0 mA							
Max. power P_o	81.0 mW							
Max. connectable inductance L_o /capacitance C_o								
IIC	L_o [mH]	72	50	10	2	1	0.5	0.2
	C_o [μ F]	0.17	0.22	0.34	0.46	0.53	0.62	0.78
IIB/IIIC	L_o [mH]	100	20	5	1	0.5	0.2	0.1
	C_o [μ F]	1.2	1.6	2.1	3.0	3.5	4.5	5.7
Resistance sensor	see value combination of connections 3							

Remote I/O

Remote I/O IS1+ Temperature input module

For Zone 1 Ex i

9482/32-08-11 Art. No. 217643



Ext. reference junction	see value combination of connections 4							
Combination of connection 3								
Sensors	up to 8 resistance temperature detectors / resistance transmitters and/or thermocouples/mV sensors							
Note	simultaneously connected in any combination of sensor types possible							
Installation type	Resistance temperature detector and resistance transmitter insulated / thermocouple and mV sensor earthed							
Reference junction resistance sensor	internal/external							
Max. output voltage U_o ext	12.92 V							
Max. current I_o	2-wire	3-wire	4-wire					
	13.1 mA	15.7 mA	19.6 mA					
Max. power P_o	2-wire	3-wire	4-wire					
	42.2 mW	50.6 mW	63.3 mW					
Max. connectable inductance L_o /capacitance C_o	L_o [mH]	100	50	20	5	1	0.5	0.2
		IIC						
	C_o [μ F]	0.19	0.25	0.31	0.40	0.54	0.63	0.78
IIB/IIIC	L_o [mH]	100	20	10	2	1	0.5	0.1
		IIB/IIIC						
	C_o [μ F]	1.3	1.7	1.9	2.5	3.0	3.5	5.7
Thermocouple/mV sensor	see values combination of connections 2							
Ext. reference junction	see values combination of connections 4							
Combination of connection 4								
Sensors	External reference junction							
Note	when connected to thermocouples/mV sensors, also simultaneously connectable to resistance temperature detectors/resistance transmitters insulated							
Installation type	insulated							
Reference junction	external (3-wire)							
Ext. reference junction								
Max. output voltage U_o ext	12.92 V							
Max. current I_o	17.4 mA							
Max. power P_o	56.2 mW							
Max. connectable inductance L_o /capacitance C_o	L_o [mH]	66	50	20	5	1	0.5	0.2
		IIC						
	C_o [μ F]	0.17	0.21	0.29	0.39	0.53	0.62	0.78
IIB/IIIC	L_o [mH]	100	20	5	1	0.5	0.2	0.1
		IIB/IIIC						
	C_o [μ F]	1.2	1.6	2.1	2.9	3.5	4.5	5.7
Resistance sensor	see value combination of connections 3							
Thermocouple/mV sensor	see values combination of connections 2							

Electrical Data

Number of channels	8 or 4 Ex i inputs (depends on operating mode)
Connection Ex i field signals	Pluggable, blue terminals, 16-pole, 2.5 mm ² , screw- or spring-type versions with lock

Auxiliary Power

Power supply connection	BusRail types 9494
-------------------------	--------------------

Remote I/O

Remote I/O IS1+ Temperature input module

For Zone 1 Ex i

9482/32-08-11 Art. No. 217643



Auxiliary Power

Auxiliary power version	Intrinsically safe Ex ia via BusRail
Current consumption	42 mA
Max. power consumption	1 W
Max. power dissipation inputs	1 W

Galvanic Isolation

Test voltage for gal. separation	According to standard EN 60079-11
Auxiliary power/system components	≥ 1500 V AC
I/O module / I/O module	≥ 500 V AC
I/O channels/system components	≥ 500 V AC
I/O channels / ground (PA)	≥ 500 V AC

Input

Sensor type 1	Resistance temperature detector Resistance transmitter
Connection type 1	2-, 3- and 4-wire circuits
Resistance range	0 – 10 kΩ
Measuring current	< 200 μA multiplexed
Measurement accuracy	± 1% (4-channel fast) 0.025% (8-channel accurate)
Linearity 1 (adjustable parameters)	Resistance-linear Temperature-linear
Sensor type 2	Thermocouples mV transmitter
Connection type 2	2-wire circuits
Signal range of inputs	-10 ... +100 mV
Linearity 2 (adjustable parameters)	Voltage-linear Temperature-linear
Max. line resistance	100 ohms per core
Input resistance	max. 10 mΩs per channel
Compensation of reference junctions	Internal (adjustable parameters) External 3-wire circuit
Min. input measuring range	-40 °C
Max. input measuring range	+80 °C
Resolution	0.1 K
Measurement accuracy reference junction	internal: 0.025 % external: depending on sensor type, see "Connectable resistance temperature detectors"
Temperature deviation	±2K for thermocouples with internal compensation

Remote I/O

Remote I/O IS1+ Temperature input module

For Zone 1 Ex i

9482/32-08-11 Art. No. 217643



Connectable resistance temperature detectors/resistance transmitters	Type		Reference	Measuring range (ITS-90)	Medium resolution	
	Pt100			IEC 60751	-200 ... +850 °C	0.1 K
Pt500			IEC 60751	-200 ... +850 °C	0.1 K	
Pt1000			IEC 60751	-200 ... +850 °C	0.1 K	
Ni100			DIN 43760	-60 ... +180 °C	0.1 K	
Ni500			DIN 43760	-60 ... +180 °C	0.1 K	
Ni1000			DIN 43760	-60 ... +180 °C	0.1 K	
Pt46			GOST 6651-94	-200 ... +1100 °C	0.15 K	
Pt50			GOST 6651-94	-200 ... +1100 °C	0.15 K	
Pt100			GOST 6651-94	-200 ... +1100 °C	0.1 K	
Cu53			GOST 6651-94	-50 ... +180 °C	0.1 K	
M50			GOST 6651-94	-200 ... +200 °C	0.15 K	
M100			GOST 6651-94	-200 ... +200 °C	0.1 K	
Potentiometer (3-wire)			--	0 ... 500 Ω	0.02 Ω	
Potentiometer (3-wire)			--	0 ... 2.5 kΩ	0.10 Ω	
Potentiometer (3-wire)			--	0 ... 5 kΩ	0.20 Ω	
Potentiometer (3-wire)			--	0 ... 10 kΩ	0.4 Ω	
Potentiometer (3-wire)			--	-200 ... +850 °C	0.1 K	
Joystick (4-wire)			--	500 ... 10 kΩ		

Reaction time	Type		Type of connection		Operating mode 4 channel fast Error control		Operating mode 8 channel precise Error control	
			Activated	Deactivated	Activated	Deactivated	Activated	Deactivated
	RTD	2-Leiter	400 ms	400 ms	750 ms	720 ms		
	RTD	3-Leiter	400 ms	400 ms	750 ms			
	RTD	4-Leiter	400 ms	400 ms	750 ms			
	R	2-wire in R	400 ms	400 ms	750 ms	720 ms		
	R	3-wire in %	90 ms	70 ms	750 ms			
	R	4-wire in R	400 ms	400 ms	750 ms			
	R	4-wire in %	90 ms	70 ms	750 ms			

To achieve the times of "error control deactivated", the error control on all channels must be "OFF"! As soon as the error control is "ON" at one channel only, the times for "error control activated" are valid.

Remote I/O

Remote I/O IS1+ Temperature input module

For Zone 1 Ex i

9482/32-08-11 Art. No. 217643



Connectable thermocouples/ mV sensors	Type	Reference	Measuring range (ITS-90)	Medium resolution	Medium meas- urement deviation with regard to measuring range
	B	IEC 60584-1	-400 ... +1800 °C	0.25 K	0.1 %
E	IEC 60584-1	-200 ... +1000 °C	0.1 K	0.013 %	
J	IEC 60584-1	-200 ... +1200 °C	0.1 K	0.014 %	
K	IEC 60584-1	-200 ... +1370 °C	0.1 K	0.02 %	
N	IEC 60584-1	-200 ... +1300 °C	0.1 K	0.02 %	
R	IEC 60584-1	-50 ... +1767 °C	0.2 K	0.05 %	
S	IEC 60584-1	-50 ... +1767 °C	0.2 K	0.053 %	
T	IEC 60584-1	-200 ... +400 °C	0.1 K	0.042 %	
L	DIN 43710	-200 ... +900 °C	0.1 K	0.027 %	
U	DIN 43710	-200 ... +600 °C	0.1 K	0.038 %	
XK	GOST 8.585	-50 ... +800 °C	0.1 K	0.02 %	
mV	--	0 ... +100 mV	3.6 µV	0.01 %	

Reaction time	Type	Type of connection	Operating mode 4 channel fast Error control Activated	Deactivated	Operating mode 8 channel precise Error control Activat- ed Deactivat- ed
		2-wire	500 ms	450 ms	800 ms
	2-wire	500 ms	450 ms	800 ms	800 ms

To achieve the times of "error control deactivated", the error control on all channels must be "OFF"! As soon as the error control is "ON" at one channel only, the times for "error control activated" are valid.

Device Specific Data

Diagnostics message module	OFF ON
Operating mode	4-channel fast (joystick) 8-channel accurate
Selection reference junction	internal / external 3-wire
External reference junction type	PT1000 PT100 GOST PT100
Sensor type	see table (connectable sensors)
Type of connection	2-, 3- and 4-wire circuits
Line fault monitoring	OFF ON
Input behaviour in case of error	hold last value
LED module requires maintenance	"M/S" LED, blue
LED operating conditions	"RUN" LED, green
LED group error	"ERR" LED, red
LED channel error	LED for each channel, red
Retrievable parameters	Hardware revision Manufacturer Serial number Software revision Type

Remote I/O

Remote I/O IS1+ Temperature input module

For Zone 1 Ex i

9482/32-08-11 Art. No. 217643



Device Specific Data

Module status and alarms	Internal bus error primer / redundant No response from IOM Configuration does not correspond to the module Hardware error Excess temperature Slot error Module requires maintenance
Signal status bit	1 = Signal valid 0 = Signal interrupted
Wire breakage input	Thermocouples > 1000 ohms Resistance transmitter > 100 ohms Resistance thermometer > 100 ohms mV transmitter > 1000 Ω
Short circuit input	Resistance transmit. < 15 Ω Resistance therm. < 15 ohms
Measuring range	Shortfall Exceedance
Influence of ambient temperature	0,025 % / 10 K

Ambient Conditions

Ambient temperature	-40°C ... +75°C
Ambient temperature	-40°F ... +167°F
Storage temperature	-40°C ... +80°C
Storage temperature	-40°F ... +176°F
Max. operating altitude	< 2000 m
Max. relative humidity	95% (without condensation)
Shock (semi-sinusoidal)	(IEC EN 60068-2-27) 15 g (3 shocks per axis and direction)
Vibration (sinusoidal)	(IEC EN 60068-2-6) Frequency range 2 ... 13.2 Hz Amplitude 1 mm (peak value) Frequency range 13.2 ... 100 Hz Acceleration amplitude 0.7 g
Electromagnetic compatibility	Tested to the following standards and regulations: EN 61326-1 (2006) IEC 61000-4-1 to 61000-4-6, NAMUR NE 21 0.1 % (8 channel precise) under strong electromagnetic influence
Note	(observe operating instructions)

Mechanical Data

Degree of protection IP (IEC 60529)	IP20
Module enclosure	Polyamide 6GF
Fire resistance (UL 94)	V2
Pollutant class	Corresponds to G3
Width	96.5 mm
Width inches	3.8 in
Height	67 mm
Length	128 mm
Length inches	5.04 in
Mounting depth inches	2.64 in
Weight	0.275 kg
Weight	0.61 lb

Remote I/O

Remote I/O IS1+ Temperature input module

For Zone 1 Ex i

9482/32-08-11 Art. No. 217643



Mounting / Installation

Mounting position	Vertical Horizontal
-------------------	------------------------

Dimensional Drawings (All Dimensions in mm [inches]) – Subject to Alterations

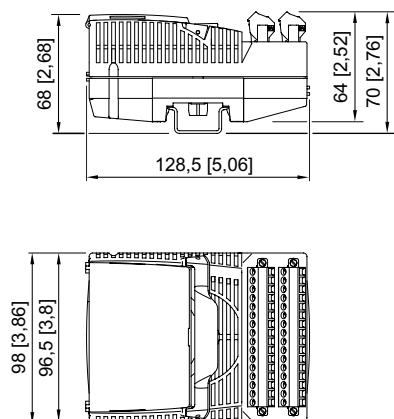





Accessories and Spare Parts

External reference junction

		Art. No.
	External reference junction for 2 x thermocouple (1 x Pt100 for 2, 3 or 4 wire connection) integrated into the 4-pole. terminal block. Installation takes place on the DIN rail.	160675

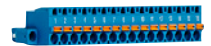
Pluggable terminal

		Art. No.
	2.5 mm ² with lock, 16-pole, screw connector, blue, for connecting the field signals to I/O modules, for intrinsically safe field circuits Labelling: 1 ... 16 Attention: An additional terminal is necessary for I/O module Series 9470 and 9482. Labelling: 17 ... 32	162702
	2.5 mm ² with lock, 16-pole, screw connector, blue for connecting the field signals to I/O modules, for intrinsically safe field circuits Labelling: 17 ... 32	162718
	2.5 mm ² with lock, 16-pole, spring clamp connection, blue, for connecting the field signals to I/O modules, for intrinsically safe field circuits, incl. test jacks Labelling: 1 ... 16 Attention: An additional terminal is necessary for I/O module Series 9470 and 9482. Labelling: 17 ... 32	162695
	2.5 mm ² with lock, 16-pole, spring clamp connection, blue for connecting the field signals to I/O modules, for intrinsically safe field circuits, incl. test jacks Labelling: 17 ... 32	162716

Labelling strips

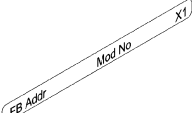
		Art. No.
	"FB Addr ... Mod No ..." for pluggable terminal, 26 pieces on the sheet	162788

Remote I/O

Remote I/O IS1+ Temperature input module

For Zone 1 Ex i

9482/32-08-11 Art. No. 217643



DIN A4 sheet

Art. No.



For the label plate on I/O modules, 6 labels per sheet
Print IS Wizard, packaging unit = 20 sheets

162832

Partition

Art. No.



For mounting between intrinsically safe and non-intrinsically safe connections of the I/O modules, in order to adhere to the required 50 mm distance

220101

Warning sign

Art. No.



"Clean modules only with a damp cloth."

162796

Resistor error message suppression

Art. No.

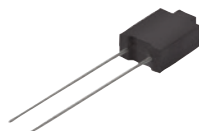

The resistors are used to suppress error messages for unused I/O channels
Resistance value: 62R / 0.5 W
Suitable for: AOM 9468; UMH 9469; DIOM 9472; TIM 9482

244912

We reserve the right to make alterations to the technical data, dimensions, weights, designs and products available without notice. The illustrations cannot be considered binding.