

SCOUT 202.930.35.2



Farbe	Artikelnummer	EAN
silber	660391	4043544692108
schwarz	660392	4043544692115
weiß	660393	4043544692122

Beschreibung

- flexibler Stromschienenstrahler in getrennter Bauform mit zylinderförmigem Lichtkopf
- Lichtkopf 355° drehbar und 90° schwenkbar über integrierten Gelenkarm
- hohe Wartungsfreundlichkeit
- keine UV- und Wärmestrahlung
- Lichtkopf aus Aluminiumdruckguss
- innovatives Wärmemanagement mit formintegrierter Passivkühlung
- High-Performance Spiegelreflektor aus Aluminium mit präziser symmetrischer Abstrahlcharakteristik für optimale Lichtausbeute und Entblendung
- Gehäuse für Betriebsgerät aus Aluminium
- reflektionsfreies EnergyVision Schutzglas klar
- 3-Phasen-Stromschienenadapter
- Betriebsgerät (LED-Konverter) integriert

Standardoptionen



Sonderoptionen

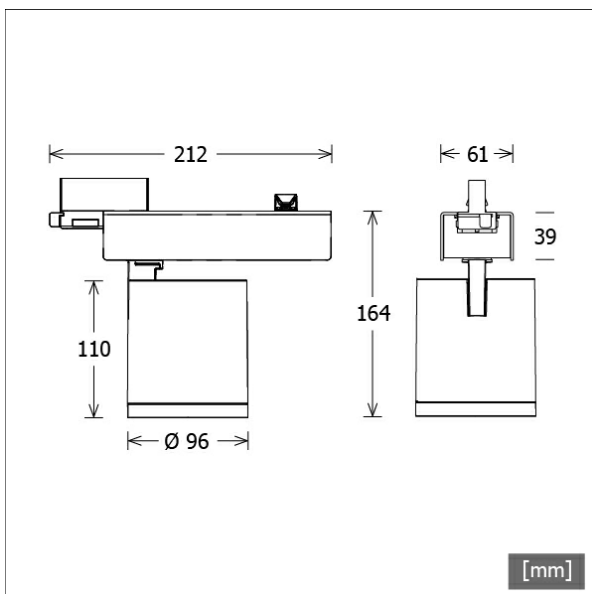

Lichttechnik / Normen

Leuchtmittel	LED Spot / CRI 90 / 3000 K
EPREL Lichtquellen	860292
Lebensdauer	L90 B50 50.000 h
	L80 B50 100.000 h
	L80 B20 50.000 h
Systemleistung	21.0 W
Leuchten-Lichtstrom	2310 lm
Systemeffizienz	110.00 lm/W
Moduleffizienz	138.73 lm/W
UGR Klasse	≤19
Abstrahlwinkel	35°
Versorgungsspannung	220 - 240 V / 50 - 60 Hz
Schutzklasse	I
Schutzart	IP20

Abmessungen / Gewichte

Länge	212 mm
Breite	96 mm
Höhe	164 mm
Durchmesser Lichtkopf	96 mm
Nettogewicht	1.14 kg
Bruttogewicht	1.22 kg



SCOUT 202.930.35.2

Scout Next (1xLED 21W 930/3000K 2310lm 35°)

— C0/C180 cd / 1000 lm

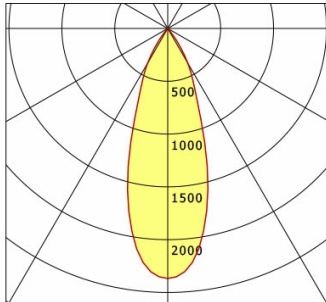

	C0	C90	C180	C270
0°	2368	2368	2368	2368
15°	1465	1465	1465	1465
30°	380	380	380	380
45°	11	11	11	11
60°	1	1	1	1
75°	0	0	0	0
90°	0	0	0	0
cd / 1000 lm				

Offset [m]	Cone width [m]	Illuminance [lx]
3.0	1.89	607.7
6.0	3.78	151.9
9.0	5.67	67.5
12.0	7.56	38.0
15.0	9.45	24.3

η	LED
Efficiency	110 lm/W
Direct/Indirect	↓ 100% / ↑ 0%
System Power	21 W
UGR	X=4H, Y=8H
Reflection factors	70/50/20
UGR C0/C180	17.1
UGR C90/C270	17.1
CIE Flux Codes	99 100 100 100 100
Ra/CRI	>90

LTS

Zubehör



EU 10
Anbau-Stromschiene Professional
(Länge: 1000 mm)



EU 20
Anbau-Stromschiene Professional
(Länge: 2000 mm)



EU 21
Anbau-Stromschiene Professional
(Länge: 3000 mm)



EU 22
Anbau-Stromschiene Professional
(Länge: 4000 mm)



EUE 20
Einbau-Stromschiene Professional
(Länge: 2000 mm)



EUE 21
Einbau-Stromschiene Professional
(Länge: 3000 mm)



EUE 22
Einbau-Stromschiene Professional
(Länge: 4000 mm)



LAB 60
3-Phasen-Einbau-Monopoint mit Busoption



LAB 60 A
3-Phasen-Anbau-Monopoint mit Busoption



ST-A 10/9000A-1-ST
Anbau-Stromschiene ONETrack Advance mit Datenbus
(Länge: 1000 mm)



ST-A 20/9000A-2-ST
Anbau-Stromschiene ONETrack Advance mit Datenbus
(Länge: 2000 mm)



ST-A 30/9000A-3-ST
Anbau-Stromschiene ONETrack Advance mit Datenbus
(Länge: 3000 mm)

SCOUT 202.930.35.2

Zubehör



ST-A 40/9000A-4-ST
Anbau-Stromschiene ONETrack Advance mit Datenbus
(Länge: 4000 mm)



ST-A MONO/9000-BPU-D
3-Phasen-Anbau-Monopoint mit Busoption



ST-E 10/9000-1-R
Einbau-Stromschiene ONETrack mit Datenbus
(Länge: 1000 mm)



ST-E 20/9000-2-R
Einbau-Stromschiene ONETrack mit Datenbus
(Länge: 2000 mm)



ST-E 30/9000-3-R
Einbau-Stromschiene ONETrack mit Datenbus
(Länge: 3000 mm)



ST-E 40/9000-4-R
Einbau-Stromschiene ONETrack mit Datenbus
(Länge: 4000 mm)



ST-E MONO/9000-BPU-D
3-Phasen-Einbau-Monopoint mit Busoption



ZBK 13
Blendklappe



ZBW 87
Wabenraster