

SCOUT 205.940.25.2

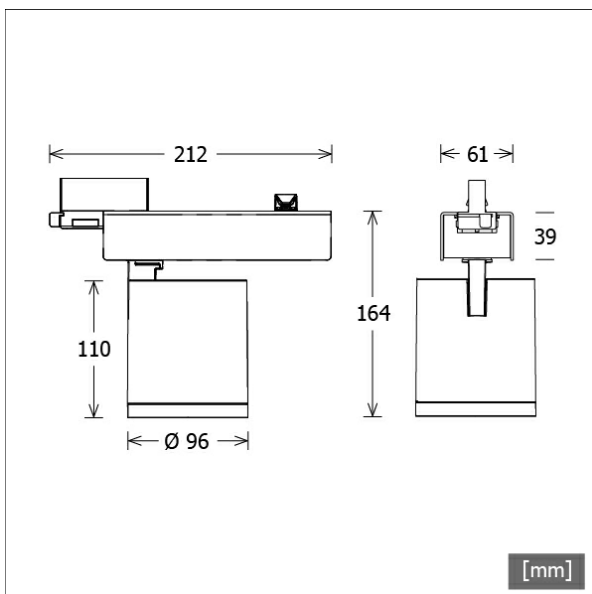

Farbe	Artikelnummer	EAN
silber	660637	4043544694638
schwarz	660638	4043544694645
weiß	660639	4043544694652



Beschreibung

- flexibler Stromschienenstrahler in getrennter Bauform mit zylinderförmigem Lichtkopf
- Lichtkopf 355° drehbar und 90° schwenkbar über integrierten Gelenkarm
- hohe Wartungsfreundlichkeit
- keine UV- und Wärmestrahlung
- Lichtkopf aus Aluminiumdruckguss
- innovatives Wärmemanagement mit formintegrierter Passivkühlung
- High-Performance Spiegelreflektor aus Aluminium mit präziser symmetrischer Abstrahlcharakteristik für optimale Lichtausbeute und Entblendung
- Gehäuse für Betriebsgerät aus Aluminium
- reflektionsfreies EnergyVision Schutzglas klar
- 3-Phasen-Stromschienenadapter
- Betriebsgerät (LED-Konverter) integriert

Standardoptionen



Sonderoptionen



Lichttechnik / Normen

Leuchtmittel	LED Spot / CRI 90 / 4000 K
EPREL Lichtquellen	848115
Lebensdauer	L90 B50 50.000 h
	L80 B50 100.000 h
	L80 B20 50.000 h
Systemleistung	45.8 W
Leuchten-Lichtstrom	5410 lm
Systemeffizienz	118.12 lm/W
Moduleffizienz	145.64 lm/W
UGR Klasse	≤19
Abstrahlwinkel	25°
Versorgungsspannung	220 - 240 V / 50 - 60 Hz
Schutzklasse	I
Schutzart	IP20

Abmessungen / Gewichte

Länge	212 mm
Breite	96 mm
Höhe	164 mm
Durchmesser Lichtkopf	96 mm
Nettogewicht	1.16 kg
Bruttogewicht	1.23 kg

SCOUT 205.940.25.2

Scout Next (1xLED 46W 940/4000K 5410lm 25°)

C0/C180 cd / 1000 lm

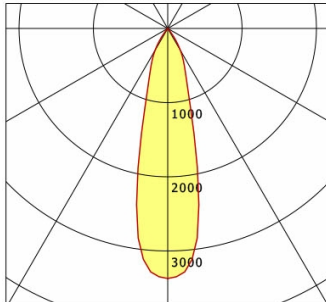

	C0	C90	C180	C270
0°	3372	3372	3372	3372
15°	1272	1272	1272	1272
30°	342	342	342	342
45°	4	4	4	4
60°	2	2	2	2
75°	0	0	0	0
90°	0	0	0	0

cd / 1000 lm

Offset [m] Cone width [m] Illuminance [lx]

Offset [m]	Cone width [m]	Illuminance [lx]
3.0	1.39	2026.6
6.0	2.78	506.7
9.0	4.17	225.2
12.0	5.57	126.7
15.0	6.96	81.1

η	LED
Efficiency	118 lm/W
Direct/Indirect	↓ 100% / ↑ 0%
System Power	46 W
UGR	X=4H, Y=8H
Reflection factors	70/50/20
UGR C0/C180	19.4
UGR C90/C270	19.4
CIE Flux Codes	99 100 100 100 100
Ra/CRI	>90

LTS

Zubehör



EU 10
Anbau-Stromschiene Professional
(Länge: 1000 mm)



EU 20
Anbau-Stromschiene Professional
(Länge: 2000 mm)



EU 21
Anbau-Stromschiene Professional
(Länge: 3000 mm)



EU 22
Anbau-Stromschiene Professional
(Länge: 4000 mm)



EUE 20
Einbau-Stromschiene Professional
(Länge: 2000 mm)



EUE 21
Einbau-Stromschiene Professional
(Länge: 3000 mm)



EUE 22
Einbau-Stromschiene Professional
(Länge: 4000 mm)



LAB 60
3-Phasen-Einbau-Monopoint mit Busoption



LAB 60 A
3-Phasen-Anbau-Monopoint mit Busoption



ST-A 10/9000A-1-ST
Anbau-Stromschiene ONETrack Advance mit Datenbus
(Länge: 1000 mm)



ST-A 20/9000A-2-ST
Anbau-Stromschiene ONETrack Advance mit Datenbus
(Länge: 2000 mm)



ST-A 30/9000A-3-ST
Anbau-Stromschiene ONETrack Advance mit Datenbus
(Länge: 3000 mm)

SCOUT 205.940.25.2

Zubehör



ST-A 40/9000A-4-ST
Anbau-Stromschiene ONETrack Advance mit Datenbus
(Länge: 4000 mm)



ST-A MONO/9000-BPU-D
3-Phasen-Anbau-Monopoint mit Busoption



ST-E 10/9000-1-R
Einbau-Stromschiene ONETrack mit Datenbus
(Länge: 1000 mm)



ST-E 20/9000-2-R
Einbau-Stromschiene ONETrack mit Datenbus
(Länge: 2000 mm)



ST-E 30/9000-3-R
Einbau-Stromschiene ONETrack mit Datenbus
(Länge: 3000 mm)



ST-E 40/9000-4-R
Einbau-Stromschiene ONETrack mit Datenbus
(Länge: 4000 mm)



ST-E MONO/9000-BPU-D
3-Phasen-Einbau-Monopoint mit Busoption



ZBK 13
Blendklappe



ZBW 87
Wabenraster