

FLIQ 400.2040.01/DALI

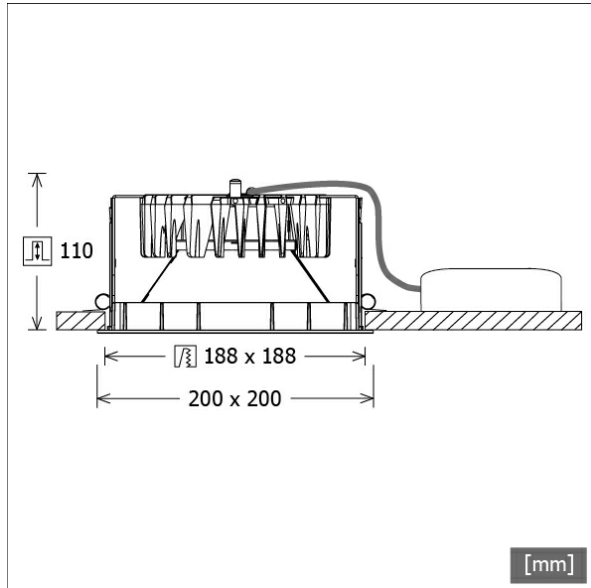

Farbe	Artikelnummer	EAN
schwarz	636480	4043544390622
silber	636481	4043544390639
weiß	636482	4043544390646



Beschreibung

- Einbau-Downlight mit optischen Designvarianten für Allgemeinbeleuchtung
- hohe Wartungsfreundlichkeit
- keine UV- und Wärmestrahlung
- innovatives Wärmemanagement mit Passivkühlung (Kühlkörper aus Aluminiumdruckguss)
- entspiegelter Mattreflektor aus Aluminium für maximale Lichtausbeute und optimale Entblendung
- Front-/Einbaurahmen aus Zinkdruckguss mit Lichteckrahmen klar (weitere Dekor-/Lichteckrahmen und Dekogläser sind als Option erhältlich)
- werkzeugloser Deckeneinbau mit Schnellspannautomatik (automatische Anpassung der Deckenstärke)
- Anschluss an Betriebsgerät über vormontiertes Leuchtenkabel
- Betriebsgerät (LED-Konverter DALI, dimmbar) inklusive (Platzierung extern)

Standardoptionen



Sonderoptionen



Lichttechnik / Normen

Leuchtmittel	LED Modul / CRI80 / 4000 K
EPREL Lichtquellen	891010
Lebensdauer	L90 B50 50.000 h L80 B50 100.000 h L80 B20 50.000 h
Systemleistung	21.0 W
Leuchten-Lichtstrom	max. 2590 lm
Systemeffizienz	123.33 lm/W
Moduleffizienz	173.48 lm/W
UGR Klasse	≤25
Versorgungsspannung	220 - 240 V / 50 - 60 Hz
Schutzklasse	III
Schutzart	IP20

Abmessungen / Gewichte

Länge	200 mm
Breite	200 mm
Höhe	112 mm
Ausschnittsmaß (LxB))	188 x 188 mm
Deckenstärke	5.0 - 50.0 mm
Einbautiefe	110 mm
Nettogewicht	1.25 kg
Bruttogewicht	1.32 kg

FLIQ 400.2040.01/DALI

Flixx 400 Square (FLIQZ 400.05, 1xLED 21W 840/4000K 2590lm)

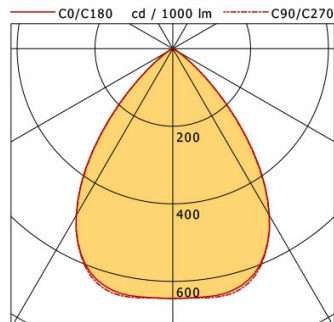

	C0	C90	C180	C270
0°	644	644	644	644
15°	639	647	639	647
30°	496	496	496	496
45°	178	174	178	174
60°	16	15	16	15
75°	4	4	4	4
90°	0	0	0	0

cd / 1000 lm

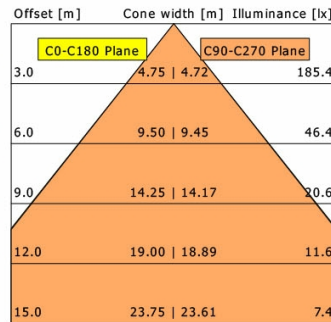

η	LED
Efficiency	123 lm/W
Direct/Indirect	↓ 100% / ↑ 0%
System Power	21 W
UGR	X=4H, Y=8H
Reflection factors	70/50/20
UGR C0/C180	20.1
UGR C90/C270	20.0
CIE Flux Codes	81 99 100 100 100
Ra/CRI	>80

LTS

Flixx 400 Square (FLIQZ 400.24, 1xLED 21W 840/4000K 2480lm)

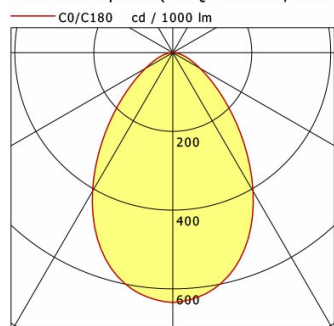

	C0	C90	C180	C270
0°	635	635	635	635
15°	577	577	577	577
30°	407	407	407	407
45°	204	204	204	204
60°	80	80	80	80
75°	27	27	27	27
90°	0	0	0	0

cd / 1000 lm

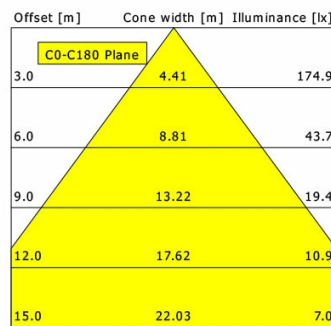

η	LED
Efficiency	118 lm/W
Direct/Indirect	↓ 100% / ↑ 0%
System Power	21 W
UGR	X=4H, Y=8H
Reflection factors	70/50/20
UGR C0/C180	23.8
UGR C90/C270	23.8
CIE Flux Codes	67 91 98 100 100
Ra/CRI	>80

LTS

Flixx 400 Square (FLIQZ 400.25, 1xLED 21W 840/4000K 2540lm)

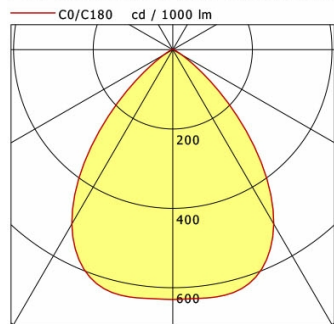

	C0	C90	C180	C270
0°	630	630	630	630
15°	629	629	629	629
30°	507	507	507	507
45°	213	213	213	213
60°	25	25	25	25
75°	5	5	5	5
90°	0	0	0	0

cd / 1000 lm

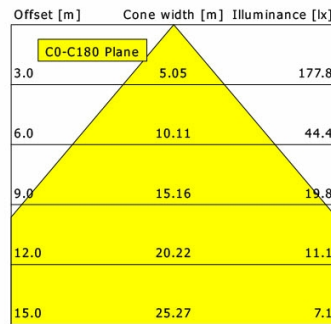

η	LED
Efficiency	121 lm/W
Direct/Indirect	↓ 100% / ↑ 0%
System Power	21 W
UGR	X=4H, Y=8H
Reflection factors	70/50/20
UGR C0/C180	20.4
UGR C90/C270	20.4
CIE Flux Codes	79 98 100 100 100
Ra/CRI	>80

LTS

FLIQ 400.2040.01/DALI

Zubehör



FLIQZ 400.01
Dekorrahmen schwarz



FLIQZ 400.02
Dekorrahmen silber



FLIQZ 400.03
Dekorrahmen weiß



FLIQZ 400.04
Lichteffektrahmen opal



FLIQZ 400.05
Lichteffektrahmen klar



FLIQZ 400.06
Lichteffektrahmen rot matt



FLIQZ 400.07
Lichteffektrahmen gelb matt



FLIQZ 400.08
Lichteffektrahmen blau matt



FLIQZ 400.16
Lichteffektrahmen rot transluzent



FLIQZ 400.17
Lichteffektrahmen gelb transluzent



FLIQZ 400.18
Lichteffektrahmen blau transluzent



FLIQZ 400.24
Dekoglas opal



FLIQZ 400.25
Dekoglas klar



NOL 50B/3H/DALI
LED-Notlichteinheit



ZVP 100
Universalverstärkungsrahmen
(Modul 625 x 625)