

FLIQ 300.2030.01/DALI

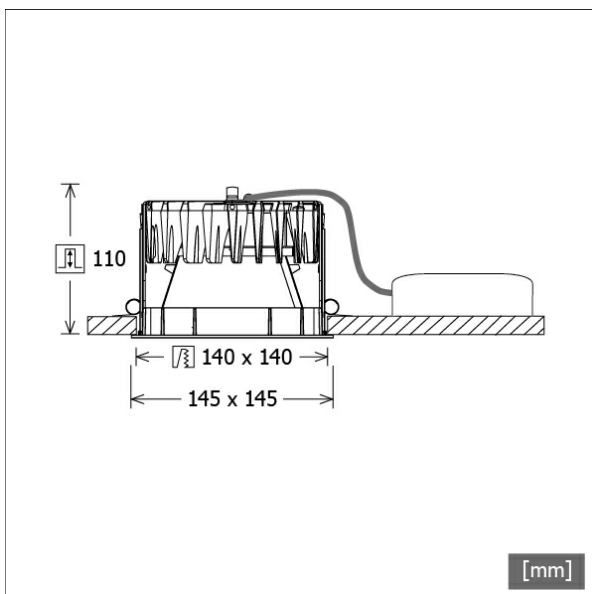

Farbe	Artikelnummer	EAN
schwarz	636453	4043544390332
silber	636454	4043544390349
weiß	636455	4043544390356



Beschreibung

- Einbau-Downlight mit optischen Designvarianten für Allgemeinbeleuchtung
- hohe Wartungsfreundlichkeit
- keine UV- und Wärmestrahlung
- innovatives Wärmemanagement mit Passivkühlung (Kühlkörper aus Aluminiumdruckguss)
- entspiegelter Mattreflektor aus Aluminium für maximale Lichtausbeute und optimale Entblendung
- Front-/Einbaurahmen aus Zinkdruckguss mit Lichteffektrahmen klar (weitere Dekor-/Lichteffektrahmen und Dekogläser sind als Option erhältlich)
- werkzeugloser Deckeneinbau mit Schnellspannautomatik (automatische Anpassung der Deckenstärke)
- Anschluss an Betriebsgerät über vormontiertes Leuchtenkabel
- Betriebsgerät (LED-Konverter DALI, dimmbar) inklusive (Platzierung extern)

Standardoptionen



Sonderoptionen



Lichttechnik / Normen

Leuchtmittel	LED Modul / CRI 80 / 3000 K
EPREL Lichtquellen	891004
Lebensdauer	L90 B50 50.000 h L80 B50 100.000 h L80 B20 50.000 h
Systemleistung	21.0 W
Leuchten-Lichtstrom	max. 2070 lm
Systemeffizienz	98.57 lm/W
Moduleffizienz	165.22 lm/W
UGR Klasse	≤25
Versorgungsspannung	220 - 240 V / 50 - 60 Hz
Schutzklasse	III
Schutzart	IP20

Abmessungen / Gewichte

Länge	145 mm
Breite	145 mm
Höhe	112 mm
Ausschnittsmaß (LxB))	140 x 140 mm
Deckenstärke	5.0 - 50.0 mm
Einbautiefe	110 mm
Nettogewicht	1.02 kg
Bruttogewicht	1.08 kg

FLIQ 300.2030.01/DALI

Flixx 300 Square (FLIQZ 300.05, 1xLED 21W 830/3000K 2070lm)

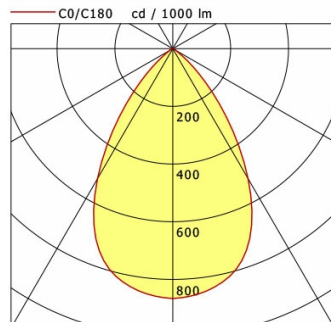

	C0	C90	C180	C270
0°	866	866	866	866
15°	805	805	805	805
30°	520	520	520	520
45°	145	145	145	145
60°	13	13	13	13
75°	6	6	6	6
90°	0	0	0	0

cd / 1000 lm

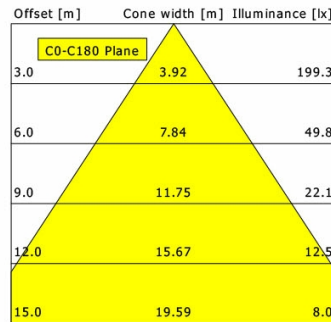

η	LED
Efficiency	99 lm/W
Direct/Indirect	↓ 100% / ↑ 0%
System Power	21 W
UGR	X=4H, Y=8H
Reflection factors	70/50/20
UGR C0/C180	20.4
UGR C90/C270	20.4
CIE Flux Codes	86 98 99 100 100
Ra/CRI	>80

LTS

Flixx 300 Square (FLIQZ 300.24, 1xLED 21W 830/3000K 2000lm)

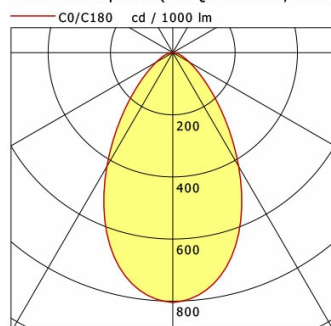

	C0	C90	C180	C270
0°	804	804	804	804
15°	698	698	698	698
30°	423	423	423	423
45°	173	173	173	173
60°	62	62	62	62
75°	22	22	22	22
90°	0	0	0	0

cd / 1000 lm

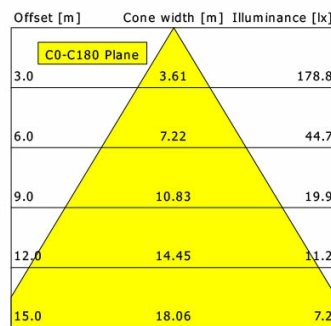

η	LED
Efficiency	95 lm/W
Direct/Indirect	↓ 100% / ↑ 0%
System Power	21 W
UGR	X=4H, Y=8H
Reflection factors	70/50/20
UGR C0/C180	24.1
UGR C90/C270	24.1
CIE Flux Codes	73 93 98 100 100
Ra/CRI	>80

LTS

Flixx 300 Square (FLIQZ 300.25, 1xLED 21W 830/3000K 2040lm)

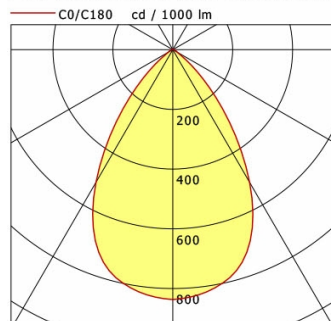

	C0	C90	C180	C270
0°	837	837	837	837
15°	779	779	779	779
30°	513	513	513	513
45°	156	156	156	156
60°	18	18	18	18
75°	6	6	6	6
90°	0	0	0	0

cd / 1000 lm

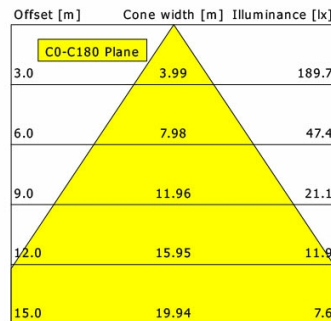

η	LED
Efficiency	97 lm/W
Direct/Indirect	↓ 100% / ↑ 0%
System Power	21 W
UGR	X=4H, Y=8H
Reflection factors	70/50/20
UGR C0/C180	20.6
UGR C90/C270	20.6
CIE Flux Codes	85 98 100 100 100
Ra/CRI	>80

LTS

FLIQ 300.2030.01/DALI

Zubehör



FLIQZ 300.01
Dekorrahmen schwarz



FLIQZ 300.02
Dekorrahmen silber



FLIQZ 300.03
Dekorrahmen weiß



FLIQZ 300.04
Lichteffektrahmen opal



FLIQZ 300.05
Lichteffektrahmen klar



FLIQZ 300.06
Lichteffektrahmen rot matt



FLIQZ 300.07
Lichteffektrahmen gelb matt



FLIQZ 300.08
Lichteffektrahmen blau matt



FLIQZ 300.16
Lichteffektrahmen rot transluzent



FLIQZ 300.17
Lichteffektrahmen gelb transluzent



FLIQZ 300.18
Lichteffektrahmen blau transluzent



FLIQZ 300.24
Dekoglas opal



FLIQZ 300.25
Dekoglas klar



NOL 50B/3H/DALI
LED-Notlichteinheit



ZVP 100
Universalverstärkungsrahmen
(Modul 625 x 625)