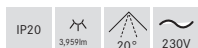
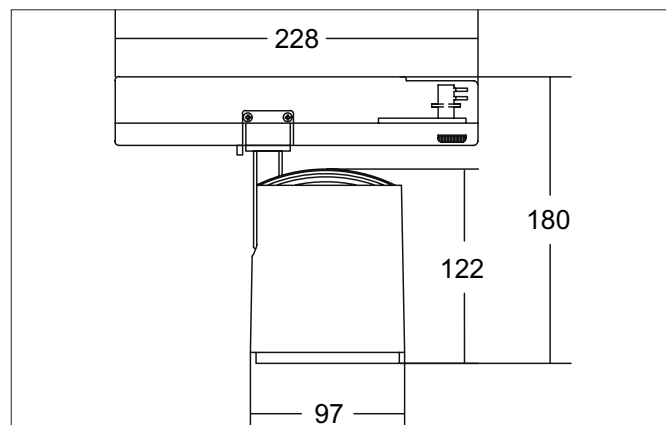

RETAIL ONE LED track spotlight, 31W

Article no. 88182174

Light.
For Generations.**Tender**

LED track spotlight, 31W, Round. Luminaire diameter 97.0 mm, Weight 0.872 kg, with rotationssymmetrical, deep, wide distributed light intensity. Luminous flux 3.959 lm, Power 1 x 31,2 W, Light colour neutral white, Correlated color temperature (CCT) 4.000 K, Colour rendering index CRI > 90, Rated life time L80/B50 at 25 °C: 50.000 h, Housing material: Aluminium, Colour: White structure, Permissible ambient temperature (ta): -20 °C - +25 °C, Protection class (EN 61140): I, Degree of protection (DIN EN 60529): IP20, .With electronic driver, on/off switchable.

Article data	
Article no.	88182174
GTIN	4251433977537
Series name	RETAIL ONE
Short description	LED track spotlight, 31W
Material	Aluminium
Colour	White
Type of surface	Structure
Shape	Round
Outer diameter	97 mm
Weight	0.872 kg

RETAIL ONE LED track spotlight, 31W

Article no. 88182174

Light.
For Generations.

Lighting technology	
Colour temperature	4.000 K
Light colour	White
Luminous flux	3,959 lm
System efficiency	127 lm/W
Colour rendering	CRI > 90
Reflector	High-gloss
Beam angle	20°
Light sharing	Symmetric
Adjustable color temperature	No

Operating technology of the luminaire	
System output	31 W
Voltage type	AC
AC nominal voltage max	230 V
Frequenz max.	50 Hz
Lamp	LED
Lamp holder	Without fitting
Protection class	I
Degree of protection	IP20
Control	on/off
Bulb change possible	The light source of this luminaire may only be replaced by the manufacturer or a service technician commissioned by him or a similarly qualified person.
Rated life time L80/B50 at 25 °C	50.000 h

Mounting technology	
Mounting method	Surface mounting
Place of installation	Ceiling-mounted
Adjustability	Rotatable and adjustable head
Swivel angle	90°
Rotation angle	350°
Head adjustable angle	90°
Suitable for through-wiring	No

Packing data	
Gross weight	1.012 kg
Length of packaging	290 mm
Packaging width	110 mm
Packaging height	165 mm
Disposal at end of life	This product must not be disposed of with household waste. You are obliged, to dispose of such electrical waste separately. By disposing of electrical waste and other old or defective electronics separately, you support recycling or other forms of re-use. In that way you help to take care and to avoid that harmful substances get into the environment.