

plug - with screwless terminals, for harsh applications



Product description	
BALS-Prd.-Nr	21841
EAN	4024941218412
Product category	QUICK-CONNECT TE plug
Current	32A
Number of poles	4p
Arrangement of phases	3P+PE
Position of earth contact	9 h
Voltage	200 - 250V~
Frequency	50/60Hz

Product description	
Protection degree	IP44
Colour code	blue RAL 5015
Colour of appliance	Collar blue RAL 5015, Housing cover blue RAL 5015, Cable gland grey RAL 7035
Connection design	screwless spring-clamp technology
Maximum conductor size	6,0 qmm
Cable entry	with cable gland
Height	180mm
Width	66mm
Depth	79mm
Material of enclosure	Polyamide
Contacts	The contact carrier is made of high temperature resistant material, the contacts are brass nickel plated

Additional technical properties	
	Multi-Grip cable gland with gasket, integrated cable clamp and additional water evacuation openings, For cable diameter from 11 up to max. 23,5 mm

Logistics data	
Weight/pcs	0.243 kg / Piece
Packaging	Bag
Content amount	1 ST
EAN	4024941218412

Logistics data	
Length	79 mm
Width	66 mm
Height	180 mm
Weight	0.244 kg
Volume	938.52 ccm
Packaging	Carton
Content amount	10 ST
EAN	4024941822602
Length	258 mm
Width	183 mm
Height	212 mm
Weight	2.582 kg
Volume	8,750 ccm

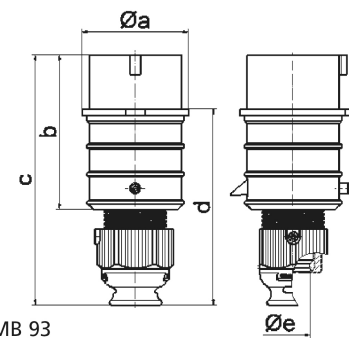

Ampere	16	16	16	32	32	32
Polzahl	3	4	5	3	4	5
a ø	51,0	57,5	65,0	66,0	66,0	72,0
b	95,0	95,0	97,0	118,0	118,0	117,0
c	145,0	145,0	152,0	178,0	178,0	181,0
d	109,0	109,0	116,0	133,0	133,0	135,5
e ø	18,0	18,0	21,0	23,0	23,0	27,0
Leiter mm² min	1	1	1	2,5	2,5	2,5
Leiter mm² max	2,5	2,5	2,5	6	6	6

2 MB 93