

phase sequence indicator - test plug



Product description	
BALS-Prd.-Nr	2220
EAN	4024941022200
Product category	Phase sequence indicator
Current	32A
Number of poles	5p
Arrangement of phases	3p+N+PE
Position of earth contact	6 h
Voltage	200/346 - 240/415V~
Frequency	50/60Hz

Product description	
Protection degree	IP44
Display of the three phases	TRUE
Motor rotation direction test.	FALSE
No-contact detection of direc.	TRUE
Height	143mm
Width	73mm
Depth	73mm

Logistics data	
Weight/pcs	0.25 kg / Piece
Packaging	Bag
Content amount	1 ST
EAN	4024941022200
Length	73 mm
Width	73 mm
Height	143 mm
Weight	0.251 kg
Volume	762.047 ccm
Packaging	Carton
Content amount	10 ST
EAN	4024941952996

Logistics data	
Length	245 mm
Width	177 mm
Height	185 mm
Weight	2.633 kg
Volume	7,140 ccm

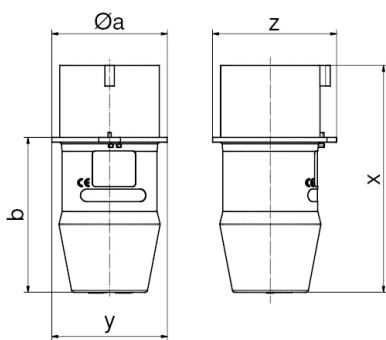

Ampere Polzahl	16 4	16 5	32 4	32 5
$\varnothing a$	58,0	64,0	66,0	73,0
b	76,0	80,0	95,0	98,0
x	112,0	116,0	141,0	144,0
y	58,0	64,0	66,0	73,0
z	63,0	68,0	78,0	79,0