

wall mounting appliance inlet - without closure cap



Product description	
BALS-Prd.-Nr	24020
EAN	4024941240208
Product category	Wall mounting appliance inlet
Current	32A
Number of poles	3p
Arrangement of phases	2P+PE
Position of earth contact	6 h
Voltage	200 - 250V~
Frequency	50/60Hz

Product description	
Protection degree	IP67
Colour code	blue RAL 5015
Colour of appliance	Housing bottom grey RAL 7035, Housing top grey RAL 7035, Collar blue RAL 5015, Bayonet ring grey RAL 7035
Connection design	with screw terminal
Maximum conductor size	6,0 qmm
Cable entry	top entry M25
Height	138mm
Width	94mm
Depth	123mm
Dimension of enclosure	75x90 mm (HxW)
Material of enclosure	Polyamide
Contacts	The contact carrier is made of polyamide, the contacts are brass nickel plated

Additional technical properties	
	The cable entry is one at top open and one rear sided closed

Logistics data	
Weight/pcs	0.306 kg / Piece
Packaging	Bag
Content amount	1 ST

Logistics data	
EAN	4024941240208
Length	123 mm
Width	94 mm
Height	138 mm
Weight	0.307 kg
Volume	1,595.556 ccm
Packaging	Carton
Content amount	10 ST
EAN	4024941970174
Length	330 mm
Width	216 mm
Height	260 mm
Weight	3.286 kg
Volume	17,062.5 ccm

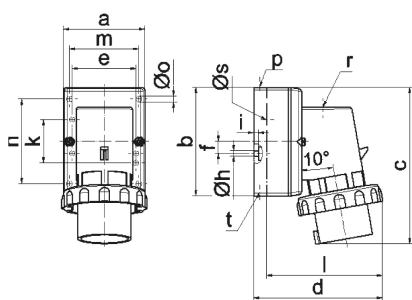

5 MB 128

Ampere Polzahl	16 3	16 4	16 5	32 3	32 4	32 5
a	64,0	75,0	84,0	90,0	90,0	90,0
b	87,0	100,0	84,0	75,0	75,0	75,0
c	137,0	151,0	136,0	138,0	138,0	139,0
d	112,0	119,0	-	122,0	122,0	123,0
e	51,0	59,0	-	-	-	-
f	-	11,0	-	-	-	-
h ø	4,1	5,1	-	-	-	-
i	4,5	4,5	-	-	-	-
k	40,0	-	-	-	-	-
l	-	-	111,0	-	-	-
m	-	-	64,0	78,0	78,0	78,0
n	-	-	64,0	45,0	45,0	45,0
o ø	-	-	5,5	5,5	5,5	5,5
p	M20	M20	-	-	-	-
r	-	-	M20	M25	M25	M25
s ø	-	-	23,0	29,0	29,0	29,0
t	für M20	für M20	-	-	-	-