

---

# LA 1118CP

---

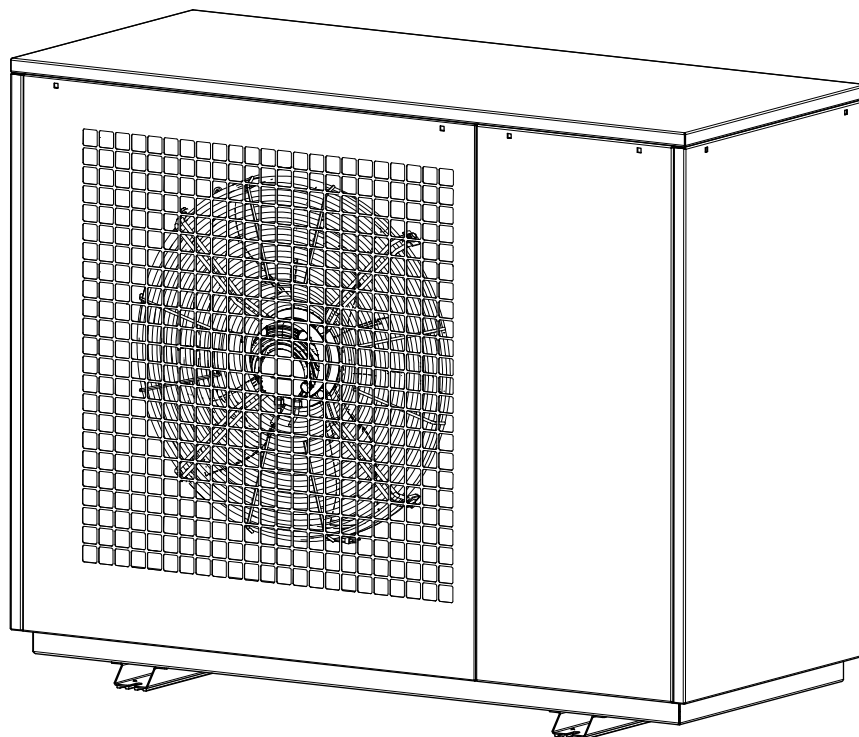

## Installation and Operating Instruction

---

Air-to-Water  
Heat Pump for  
Outdoor Installation



## Table of contents

<b>1</b>	<b>Safety notes</b> .....	<b>EN-3</b>
1.1	Layout of safety notes and identification .....	EN-3
1.2	General safety notes .....	EN-3
1.3	Intended use.....	EN-4
1.4	Legal regulations and directives .....	EN-4
1.5	Energy-efficient use of the heat pump.....	EN-4
<b>2</b>	<b>Intended use of the heat pump</b> .....	<b>EN-5</b>
2.1	Area of application.....	EN-5
2.2	Operating principle.....	EN-5
<b>3</b>	<b>Scope of supply</b> .....	<b>EN-6</b>
3.1	Basic device .....	EN-6
3.2	Connection box .....	EN-6
3.3	Heat pump manager .....	EN-6
<b>4</b>	<b>Accessories</b> .....	<b>EN-6</b>
4.1	Building management system.....	EN-6
<b>5</b>	<b>Transport</b> .....	<b>EN-7</b>
<b>6</b>	<b>Installation</b> .....	<b>EN-8</b>
6.1	General.....	EN-8
6.2	General requirements for heat pump installed outdoors.....	EN-9
6.3	Safety zone for 200 mm raised installation.....	EN-10
6.4	Safety zone for floor level installation .....	EN-12
6.5	Condensate pipe for heat pumps with flammable refrigerant.....	EN-14
<b>7</b>	<b>Assembly</b> .....	<b>EN-15</b>
7.1	General.....	EN-15
7.2	Opening the covering panels.....	EN-15
7.3	Connection on heating side .....	EN-16
7.4	Water quality in heating systems.....	EN-17
7.5	Temperature sensor .....	EN-19
7.6	Electrical connection .....	EN-20
<b>8</b>	<b>Commissioning</b> .....	<b>EN-21</b>
8.1	General.....	EN-21
8.2	Preparation.....	EN-21
8.3	Procedure .....	EN-21
<b>9</b>	<b>Cleaning work</b> .....	<b>EN-22</b>
9.1	General.....	EN-22
9.2	Cleaning the heating system .....	EN-22
9.3	Cleaning the air system.....	EN-22
<b>10</b>	<b>Care</b> .....	<b>EN-23</b>
<b>11</b>	<b>Faults/troubleshooting/repair</b> .....	<b>EN-23</b>
11.1	Refrigerant handling .....	EN-24
<b>12</b>	<b>Decommissioning/disposal</b> .....	<b>EN-25</b>
<b>13</b>	<b>Device information</b> .....	<b>EN-26</b>
<b>14</b>	<b>Product information as per Regulation (EU) No 813/2013, Annex II, Table 2</b> .....	<b>EN-28</b>
<b>15</b>	<b>Dimension drawings</b> .....	<b>EN-29</b>
15.1	Dimension drawing.....	EN-29
15.2	Dimension drawing legend.....	EN-30
<b>16</b>	<b>Diagrams</b> .....	<b>EN-31</b>
16.1	Heating curve .....	EN-31
16.2	Cooling curve .....	EN-35
16.3	Heating operating limit.....	EN-36
16.4	Cooling operating limit.....	EN-37

<b>17 Integration Diagram.....</b>	<b>EN-38</b>
17.1 Hydraulic integration diagram .....	EN-38
17.2 Hydraulic integration diagram .....	EN-39
17.3 Legend.....	EN-40
<b>18 Declaration of conformity .....</b>	<b>EN-41</b>

# 1 Safety notes

## 1.1 Layout of safety notes and identification

The safety notes in the text provide warnings about potential hazards before the beginning of an instruction.

The safety instructions have the following structure:

	Meaning
1	Signal word (DANGER, WARNING, CAUTION or NOTE)
2	Nature and source of the hazard, description of the hazard and its cause
3	Consequence: Description of the possible consequences for people, animals and the environment that can occur due to the hazard
4	Escape: Recommended actions for averting hazards

### **DANGER!**

Direct risk of death or serious personal injury.

### **WARNING!**

Risk of minor to serious personal injury

### **CAUTION!**

Risk of minor injury or damage to property or the environment

### **NOTE**

Risk of damage to property or minor personal injury or important information with no further risk of personal injury or damage to property.

## 1.2 General safety notes

The following warnings and safety notes must be observed in all life phases of the device:

### **DANGER!**

Risk of death due to fire or explosion.

The device contains flammable refrigerant (R290). In case of leakage, the refrigerant can mix with the ambient air and form a flammable atmosphere.

- ▶ Work on the heat pump is only to be carried out by people with the knowledge set out in Fig. 1.1 on page 4.
- ▶ Avoid ignition sources (naked flames, hot surfaces, electrical equipment with ignition sources and static discharge) and fire loads in the safety zone

### **WARNING!**

Risk of injury and damage to property due to improper handling.

- ▶ Work on the heat pump is only to be carried out by people with the knowledge set out in Fig. 1.1 on page 4.

### **DANGER!**

Risk of death due to electric shock.

If the device is not fitted with all covering panels there is a risk of electric shock.

- ▶ Disconnect all electric circuits from the power source prior to opening the device.

### **WARNING!**

Risk of injury.

When working on the device without protective equipment, injuries can occur, e.g. cuts.

- ▶ Use of personal protective equipment (PPE) in accordance with DGUV regulation 100-500 Chap. 2.35
- ▶ Personal protective equipment consisting of safety gloves, safety shoes, safety glasses and long clothing that fully covers the body.

### **WARNING!**

Risk of injury due to falling or slipping.

Trip hazards and leaked operating materials result in a risk of injury due to falling or slipping.

- ▶ Trip hazards caused by cables, pipes and hoses must be avoided.
- ▶ Operating material leaks must be absorbed with suitable binding agents and disposed of in accordance with the hazard class.

### **DANGER!**

Risk of death due to electric shock.

There is a risk of electric shock from contact with live parts.

- ▶ National and regional regulations on accident prevention and carrying out electrical installations must be observed.
- ▶ The following five safety rules should be used during electrical installation:
  - Disconnect from mains,
  - Secure against reconnection,
  - Confirm absence of voltage at all poles,
  - Ground and short-circuit,
  - Cover or cordon off neighbouring areas that are live.
 After disconnecting the power supply, you have to wait 5 minutes before all components are de-energised.
- ▶ Only operate the heat pump with safety equipment (casing, grating).

### **DANGER!**

Risk of death due to fire or explosion.

The device contains flammable refrigerant (R290). Alterations or modifications to the device can cause uncontrolled conditions that can lead to refrigerant leakage.

- ▶ Please refrain from modifying or altering the device.

### 1.3 Intended use

This device is only intended for use (see chap. 2) as specified by the manufacturer. Any other use beyond that intended by the manufacturer is prohibited. This requires the user to abide by the relevant project planning documents. Please refrain from modifying or altering the device.

### 1.4 Legal regulations and directives

The construction and design of the heat pump comply with all valid EU directives, DIN and VDE regulations (see CE Declaration of conformity).

When connecting the heat pump to the power supply, the relevant VDE, EN and IEC standards must be complied with. Any further connection requirements stipulated by local utility companies must also be observed.

When connecting the heating system, the applicable regulations must be complied with.

The device is filled with flammable refrigerant R290 (propane) and is only intended for outdoor installation. Suitable safety measures must be implemented for installation, assembly, operation and disposal.

Work on the heat pump must only be carried out by people with the following knowledge. Use by people who have not been instructed is not permissible.

Activity	Instructed persons	Qualified specialist	Authorised and qualified after-sales service technician
Transport, storage		X	X
Installation		X	X
Assembly		X	X
Commissioning			X
Operation	X	X	X
Cleaning work		X	X
Care	X	X	x
Faults / troubleshooting / repair		X	X
Decommissioning / disposal			X

Fig. 1.1: Phases and authorised persons

#### **WARNING!**

**Risk of injury and damage to property due to improper handling.**

- ▶ **Work on the heat pump is only to be carried out by people with the knowledge set out in Fig. 1.1 on page 4.**

#### **NOTE**

**When operating a heat pump, the legal requirements of the country where the heat pump is operated must be complied with.**

This device can be used by children aged 8 and over and by persons with limited physical, sensory or mental aptitude or lack of experience and/or knowledge, providing they are supervised or have been instructed in safe use of the device and understand the associated potential dangers.

Children must not play with the device. Cleaning and user maintenance must not be carried out by children without supervision.

### 1.5 Energy-efficient use of the heat pump

By operating this heat pump, you are helping to protect the environment. A prerequisite for energy-efficient operation is the correct design of the heat source system and heating system.

To maintain heat pump efficiency, it is particularly important to keep the temperature difference between the heating water and heat source to a minimum. For this reason, it is advisable to design the heat source and heating system very carefully. **A temperature difference that is higher by 1 Kelvin (1°C) increases the power consumption by around 2.5%.** When designing the heating system, it should be borne in mind that special consumers such as domestic hot water preparation should also be taken into consideration and dimensioned for low temperatures. **Underfloor heating systems (panel heating)** are optimally suited for heat pump use on account of the low flow temperatures (30 °C to 40 °C).

It is important to ensure that the heat exchangers are not contaminated during operation, as this increases the temperature difference, which in turn reduces the coefficient of performance (COP).

When set correctly, the heat pump manager is also an essential factor in the energy-efficient use of the heat pump. Further information can be found in the heat pump manager operating instructions.

## 2 Intended use of the heat pump

### 2.1 Area of application

The air-to-water heat pump is to be used exclusively for the heating and cooling of heating water. It can be used in new or existing heating systems.

The heat pump is designed exclusively for outdoor installation. The instructions in the chapter "**Installation**" must be observed.

The circulating pump(s) must be controlled using the heat pump manager.

If pump functions relevant to the overall function or to safety are not supported, e.g. due to integration of the heat pump into a building management system, this results in the warranty being void and can lead to damage to the heat pump.

The circulating pump(s) and the heat pump controller must always be ready for operation.

The specifications in the technical documents must be followed, particularly limit values for the minimum and – if available – maximum warm/cold water volume flow.

The heat pump is suitable for mono energy and bivalent operation in outside air temperatures to  $-22^{\circ}\text{C}$ .

Proper defrosting of the evaporator is guaranteed by maintaining a heating water return temperature of more than  $20^{\circ}\text{C}$  during continuous operation. The maximum water outlet temperature must not exceed  $65^{\circ}\text{C}$  and must be secured on the system side so that, if the temperature is exceeded, all additional heat sources are switched off safely.

The heat pump is not designed for the increased heat consumption required when a building is being dried out. For this reason, the additional heat consumption should be met using special devices provided by the customer. For drying out a building in autumn or winter, it is advisable to install a suitable 2nd heat generator (e.g. an electric heating element available as an accessory).

In cooling operation, the heat pump is suitable for air temperatures ranging from  $+15^{\circ}\text{C}$  to  $+45^{\circ}\text{C}$ .

It can be used for silent and dynamic cooling. The minimum cooling water outlet temperature is  $+12^{\circ}\text{C}$ .



#### **CAUTION!**

**Use of a 4-way valve on the heating water side can cause damage to the device.**

► **A 4-way valve must not be used on the heating water side**

## 2.2 Operating principle

### Heating with the heat source air

Surrounding air is drawn in by the fan and fed through the evaporator (heat exchanger). The evaporator cools the air, i.e. extracts heat from it. This extracted heat is then transferred to the working medium (refrigerant) in the evaporator.

The heat is "pumped" to a higher temperature level by increasing its pressure with the aid of the electrically driven compressors. It is then transferred to the heating water via the liquefier (heat exchanger).

Electrical energy is used to raise the temperature level of the heat from the environment. Since the energy extracted from the air is transferred to the heating water, this type of device is referred to as an air-to-water heat pump.

The air-to-water heat pump consists of the main components evaporator, fan and expansion valve, as well as the low-noise compressors, the liquefier and the electrical control system.

At low ambient temperatures, humidity accumulates on the evaporator in the form of frost, reducing the transfer of heat. Uneven accumulation during this process does not indicate a fault. The evaporator is defrosted automatically by the heat pump as required. Under certain atmospheric conditions, steam may be emitted from the air outlet.

### Cooling

The functions of the evaporator and the liquefier are reversed in the "Cooling" operating mode.

The heating water transfers its heat to the refrigerant via the liquefier, which is now functioning as an evaporator. The refrigerant is brought to a higher temperature level using the compressor. Heat is transferred to the surrounding air via the liquefier (which, in heating operation, functions as an evaporator).

## 3 Scope of supply

### 3.1 Basic device

The heat pump contains the components listed below.

R290 (propane) is used as refrigerant.

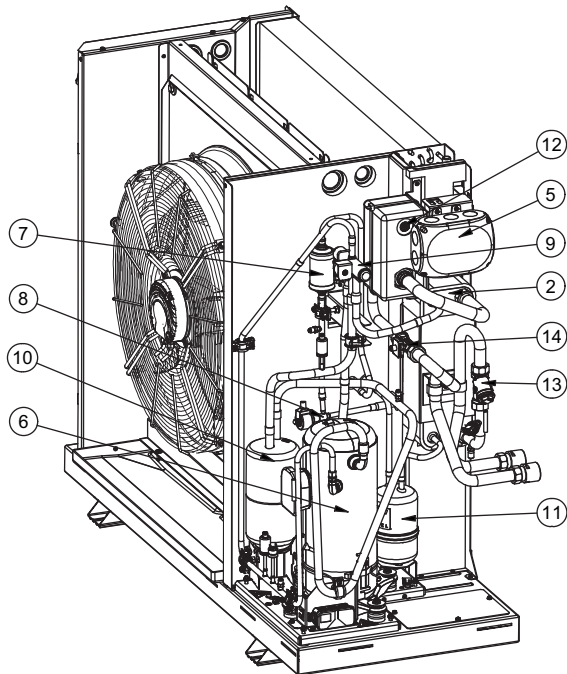

- 1) Evaporator, air
- 2) Liquefier
- 3) Fan
- 4) Switch box
- 5) Connection box
- 6) Compressor
- 7) Filter dryer

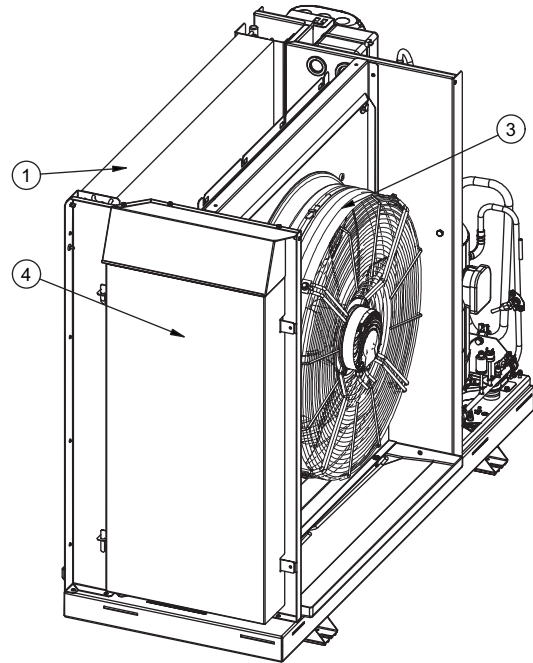

- 8) Expansion valve
- 9) 4-way reversing valve
- 10) Separator
- 11) Collector
- 12) Ventilator
- 13) Dirt trap
- 14) Flow rate sensor

### 3.2 Connection box

The connection box (5) contains the supply connection terminals (load/control voltage) and the connecting terminals for the communication line.

#### **i** NOTE

**Connection work must only be carried out on the connection box.**

### 3.3 Heat pump manager

A heat pump manager (controller -N1) must be used for operating your heat pump.

The heat pump manager is a convenient electronic regulation and control unit. It controls and monitors the entire heating system based on the outside temperature, as well as domestic hot water preparation and operating limits.

The external temperature sensor to be mounted on-site is included in the heat pump manager scope of supply together with the necessary fixing accessories.

The functions and usage of the heat pump manager are described in the operating instructions supplied with it.

## 4 Accessories

### 4.1 Building management system

The heat pump manager can be connected to a building management system network via supplementation of the relevant interface plug-in card. The supplementary installation instructions of the interface card must be consulted regarding the exact connection and parametrisation of the interface.

The following network connections can be made on the heat pump manager:

- Modbus
- EIB, KNX
- Ethernet



## 5 Transport

### **!** DANGER!

Risk of death due to fire and explosion.

If there is a leakage of the propane refrigerant during transportation, an ignitable atmosphere can form in the transport vehicle.

- ▶ An adequate air supply must be ensured during transportation.
- ▶ For transportation in a small transporter connected to the passenger compartment, avoid ignition sources such as sparks or smoking and ensure adequate ventilation.

### **!** WARNING!

Risk of injury due to tipping.

- ▶ The machine must be secured to prevent tipping.

### **!** DANGER!

Risk of death due to fire and explosion.

If a leakage occurs during transportation or storage, an ignitable atmosphere can form.

- ▶ The device must only be stored in rooms with no permanent ignition sources.
- ▶ Where possible, store the heat pump above ground and ensure adequate ventilation.

### **!** DANGER!

Risk of death due to fire and explosion.

If there is a leakage of the propane refrigerant due to a fault, an ignitable atmosphere can form.

- ▶ Avoid ignition sources and fire loads in the safety zone.
- ▶ Keep the casing closed.

### **!** DANGER!

Risk of death due to fire and explosion hazard.

Flammable refrigerant may leak if the heat pump falls or is subject to impact loads during transportation.

- ▶ Protect against mechanical damage during transportation.
- ▶ The heat pump must be checked immediately for leakages if it falls or is subject to impact loads during transportation.
- ▶ Avoid setting down the system heavily.
- ▶ If outflow noises can be heard, if oily surfaces form or if a leakage can be detected with a detector, the refrigerant must be drained off by a person trained in handling of propane.
- ▶ Ignition sources in the area around the device must be avoided until the draining is safely completed. If the leakage occurs inside a building, the affected area must be ventilated immediately.
- ▶ The heat pump must be returned to the manufacturer for repair if it is not possible to remedy the leakage on site.

### **!** DANGER!

Risk of death due to lightning.

Standing outside during a storm can result in a risk of death.

- ▶ Do not stand in the immediate vicinity of the heat pump.

Transportation, including all related activities such as lifting, loading, lowering, unloading and unpacking, must be carried out by trained personnel.

The transport routes must be cleared and suitable agents must be spread if necessary (for defrosting or increasing grip).

Only use suitable transport equipment. The carrying capacity of the load suspension device (slings and straps) must be observed.

Personal protective equipment must be used when transporting and removing the transport packaging in accordance with DGUV regulation 100-500 Chap. 2.35

The pallet should be used for transportation to the final installation location. The device can also be carried using slings or straps fed between the baseplate and the floor brackets. (see figure)

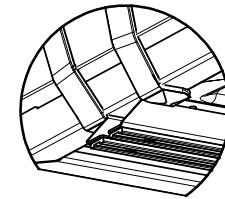
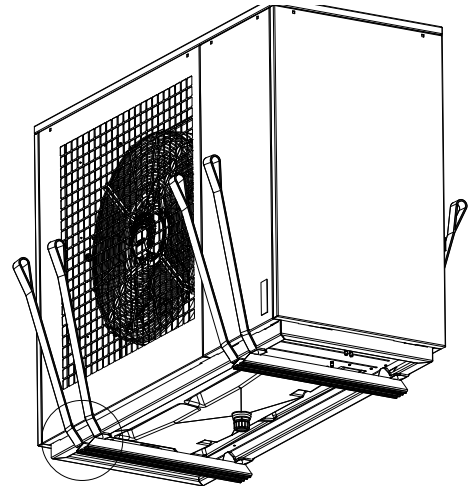

After transportation, the transport fastening in the device is to be removed from both sides of the base.

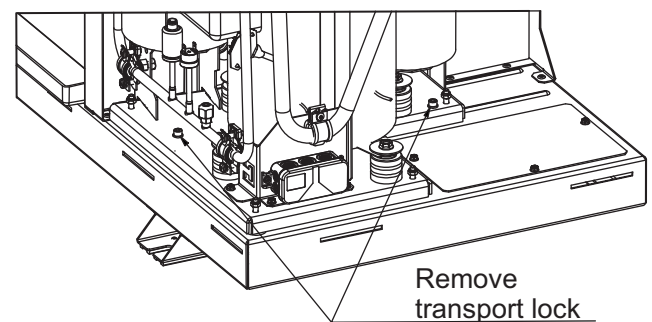

### **i** NOTE

Before commissioning, the transport fastening must be removed.

## 6 Installation

### 6.1 General

These specifications have priority during installation and operation of the system and must be complied with. The responsibility for this lies with the specialist system construction company.

The heat pump, especially its refrigeration circuit, must be protected against damage (e.g. drilling, burning etc.) during installation and other construction activities.

#### **DANGER!**

**Risk of death due to fire and explosion.**

If there is a leakage of the propane refrigerant due to a fault, an ignitable atmosphere can form.

- ▶ Avoid ignition sources and fire loads in the safety zone.
- ▶ Keep the casing closed.

The heat pump is not an ignition source.

#### **DANGER!**

**Risk of death due to fire and explosion.**

If there is a leakage of the propane refrigerant due to a fault, an ignitable atmosphere can form, especially in hollows, shafts or areas with no free air outflow or air exchange.

- ▶ Installation in hollows, shafts or areas with no free air outflow or air exchange is not permitted.

#### **DANGER!**

**Risk of death due to fire and explosion.**

In the very unlikely event that propane gets into the heating circuit, an ignitable atmosphere can form due to mixing with the surrounding air.

- ▶ The minimum volume of the room in which the hydraulic system - comprising the safety group, automatic air vent and buffer - is installed must not be less than 12 m<sup>3</sup>.

#### **NOTE**

Observe country-specific building regulations.

#### **NOTE**

The responsibility for heat pump installation lies with the specialist system construction company.

#### **NOTE**

Once the heat pump has been commissioned by an authorised and qualified after-sales service technician, the responsibility for the intended operation of this heat pump lies with the operator.

#### **NOTE**

The heat pump is not intended for use above 2000 metres (mean sea level).

## 6.2 General requirements for heat pump installed outdoors

The heat pump device must be installed on a suitably stable foundation or on a permanently level, smooth and horizontal surface. The heat pump can be installed raised by 200 mm (see Chap. 6.3 on page 10) or level with the ground (see Chap. 6.4 on page 12).

Furthermore, the heat pump should be installed so that the air outlet direction of the fan is perpendicular to the main wind direction to allow proper defrosting of the evaporator in the event of high wind exposure.

The cover panels on the baseplate in the machine room must remain sealed with connection to the rear (standard configuration) to guarantee optimum sound insulation and to protect the interior of the device from small animals.

To enable this to be ensured with vertical connection of the heat pump (optional accessories), it is essential to ensure that all panels are fitted on the installation shaft when assembly work is complete.

- For installations on a foundation with direct contact to the building, vibration insulation must be ensured to avoid transmission of solid-borne noise to the building.
- It must be assessed whether lightning protection is required and, if necessary, implemented.
- During the installation, the circumstances at the installation location, such as building regulations, static load of the building, wind exposure and lightning protection, must be taken into account.
- If the installation is close to walls, it must be noted that there may be more contamination in the intake and air outlet area due to the air flow. For installation close to walls, the heat pump must be able to blow out air freely for energy reasons.
- When installing multiple heat pumps, the safety zone ① must be established around the entire group of heat pumps.
- To carry out maintenance work, a service area ② with the clearances shown must be kept freely accessible. When installing multiple heat pumps, observe the service clearances ② between the individual heat pumps.
- Installation on the roof is permitted. The safety clearances indicated must be adhered to.
- When using heat pumps close to the sea, the high salt content in the air may lead to increased corrosion. The use of heat pumps is safe from a distance of 12 km from the sea with a maximum salt content of 3.5%.  
For shorter distances, refer to the more detailed distance calculation in the project planning manual
- The device must not be exposed to corrosive or permanently dusty air. (e.g. close to stables). The air containing dust and / or ammonia can cause permanent damage to the device.

### **DANGER!**

Risk of death due to fire and explosion.

If there is a leakage of the propane refrigerant due to a fault, an ignitable atmosphere can form.

- ▶ Install the heat pump in such a way that in the event of a leakage no refrigerant can get into the building.
- ▶ Empty conduits, openings etc. that lead into the building, shafts etc. must be fitted with an air tight seal.

Empty conduits, openings etc. that lead into the building, shafts etc. must be fitted with an air tight seal.

If other equipment is installed inside the safety zone ① these components located in the safety zone must not represent an ignition source or fire load.

### **NOTE**

Do not restrict the air intake and air outlet area of the fan.

### **CAUTION!**

If the heat pump takes in cooled air close to the ground, this can cause damage or reduced efficiency.

- ▶ Do not install the device in depressions or courtyards.

### **DANGER!**

Risk of death due to fire and explosion.

Damage to the refrigeration circuit during construction work can result in leakage of the propane refrigerant. This can cause an ignitable atmosphere.

- ▶ Protect the heat pump from damage during installation and other construction work.

### **NOTE**

Structural influences must be observed for installation close to walls. No windows or doors should be present in the area surrounding the air outlet of the fan.

### **NOTE**

In cases of installation close to walls, there may be more sediment in the intake and air outlet area due to the air flow. The colder outside air outlet should discharge in such a way as to not increase the heat losses in heated neighbouring rooms.

### 6.3 Safety zone for 200 mm raised installation

If the device is raised above the installation surface by 200 mm using a strip footing or other suitable method, a **safety zone ① of 1 metre** must be maintained all the way around the device. There must not be any ignition sources such as sockets, light switches, lamps, electrical switches or other permanent ignition sources, windows doors, ventilation openings, light wells, drainage openings and similar in this zone. Fire loads must also be avoided. Open drains to a lower level are permitted providing there are no openings into the sewer system within 1 metre

around them. Building openings must be made airtight within the safety zone. The safety zone must not protrude onto neighbouring property or public traffic areas. The device must be positioned so that in the event of a leakage no refrigerant can get into neighbouring buildings.

If the device is to be installed on a continuous foundation, a cut-out in the area of the condensate outlet is recommended to allow connection work on the condensate drain to be carried out with no problems.

No structural modifications are to be made in the safety zone that could violate the integrity of the safety zone.

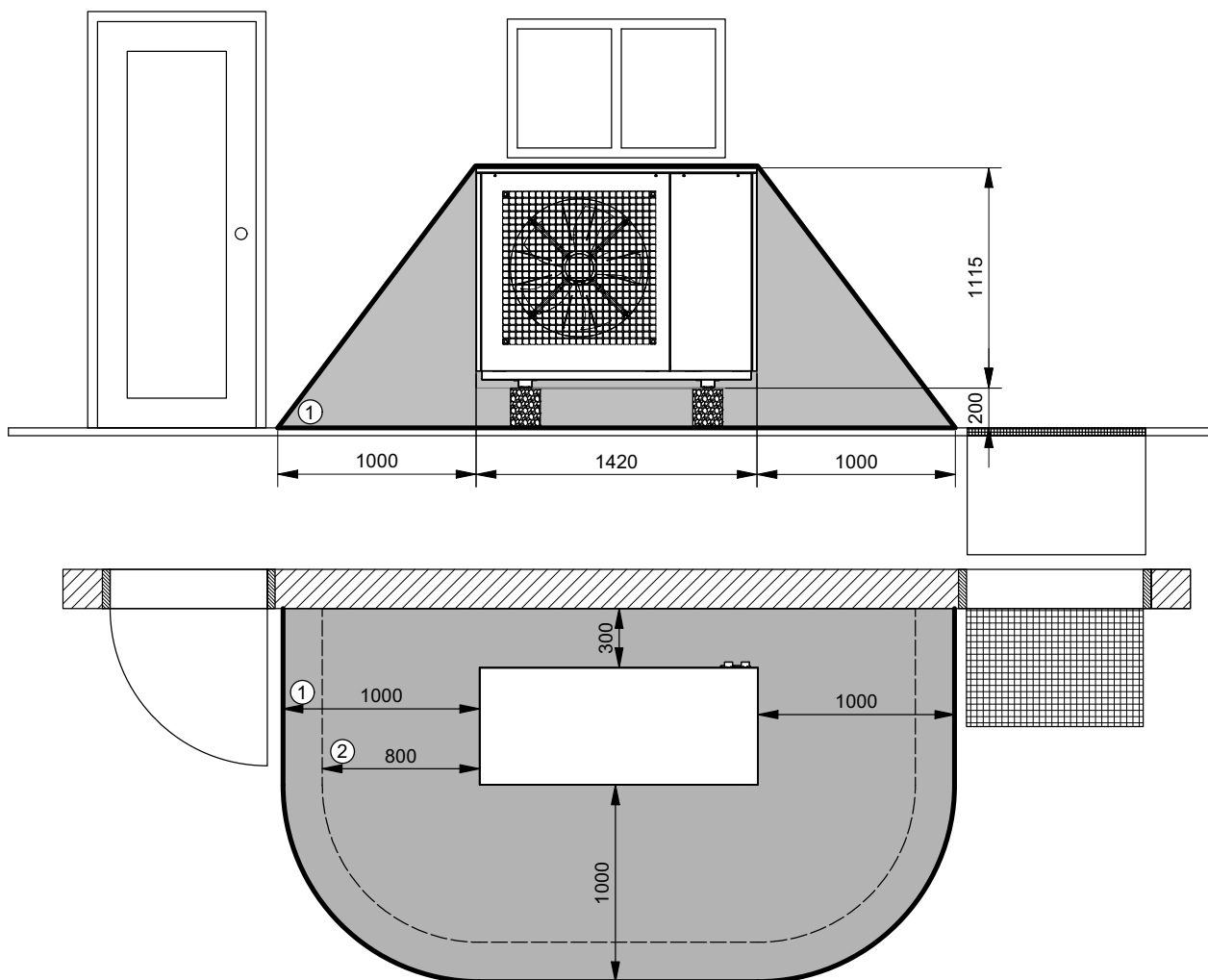

Fig. 6.1: Safety zone (raised installation) around the heat pump

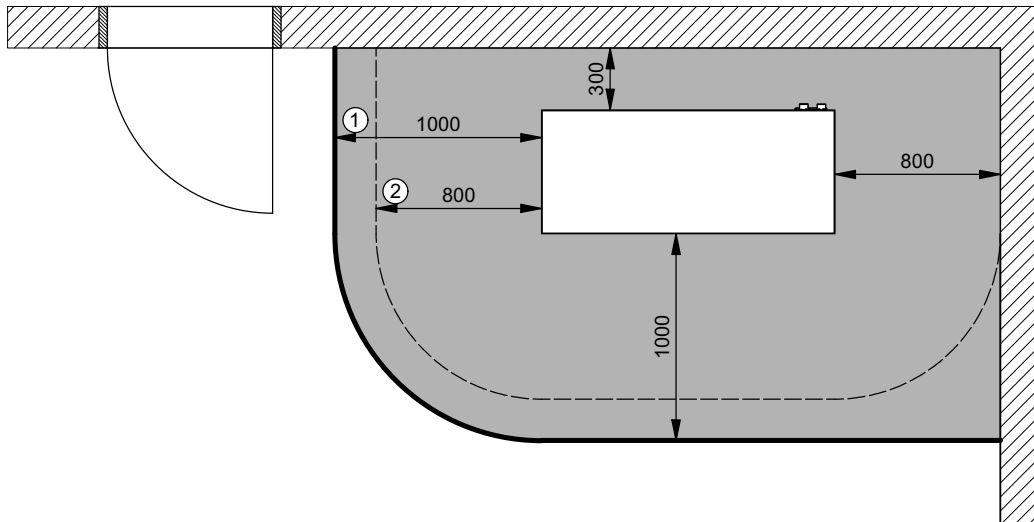

Fig. 6.2: Safety zone (raised installation) for installation in a corner

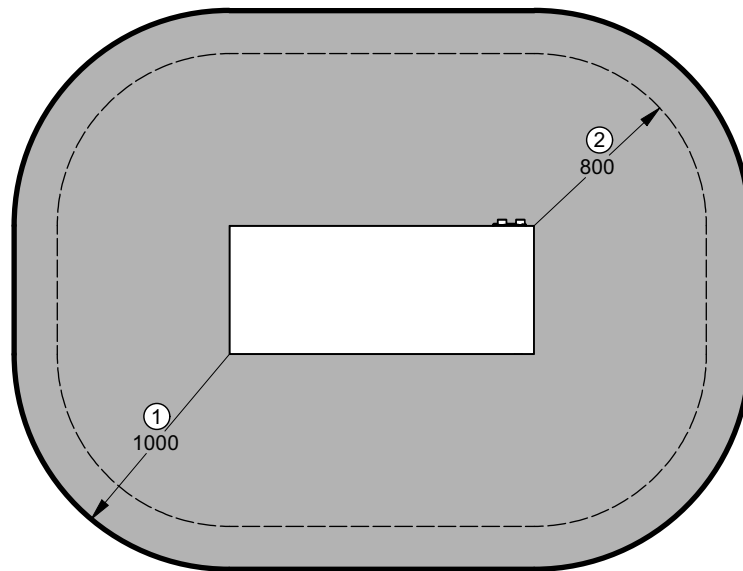

Fig. 6.3: Safety zone (raised installation) for installation in open space

## 6.4 Safety zone for floor level installation

If the device is installed at floor level, a **safety zone ① of 2 meters** must be observed all the way around the device. There must not be any ignition sources such as sockets, light switches, lamps, electrical switches or other permanent ignition sources, windows doors, ventilation openings, light wells, drainage openings and similar in this zone. Fire loads must also be

avoided. Open drains to a lower level are permitted providing there are no openings into the sewer system within 2 metre around them. Building openings must be made airtight within the safety zone. The safety zone must not protrude onto neighbouring property or public traffic areas. The device must be positioned so that in the event of a leakage no refrigerant can get into neighbouring buildings.

No structural modifications are to be made in the safety zone that could violate the integrity of the safety zone.

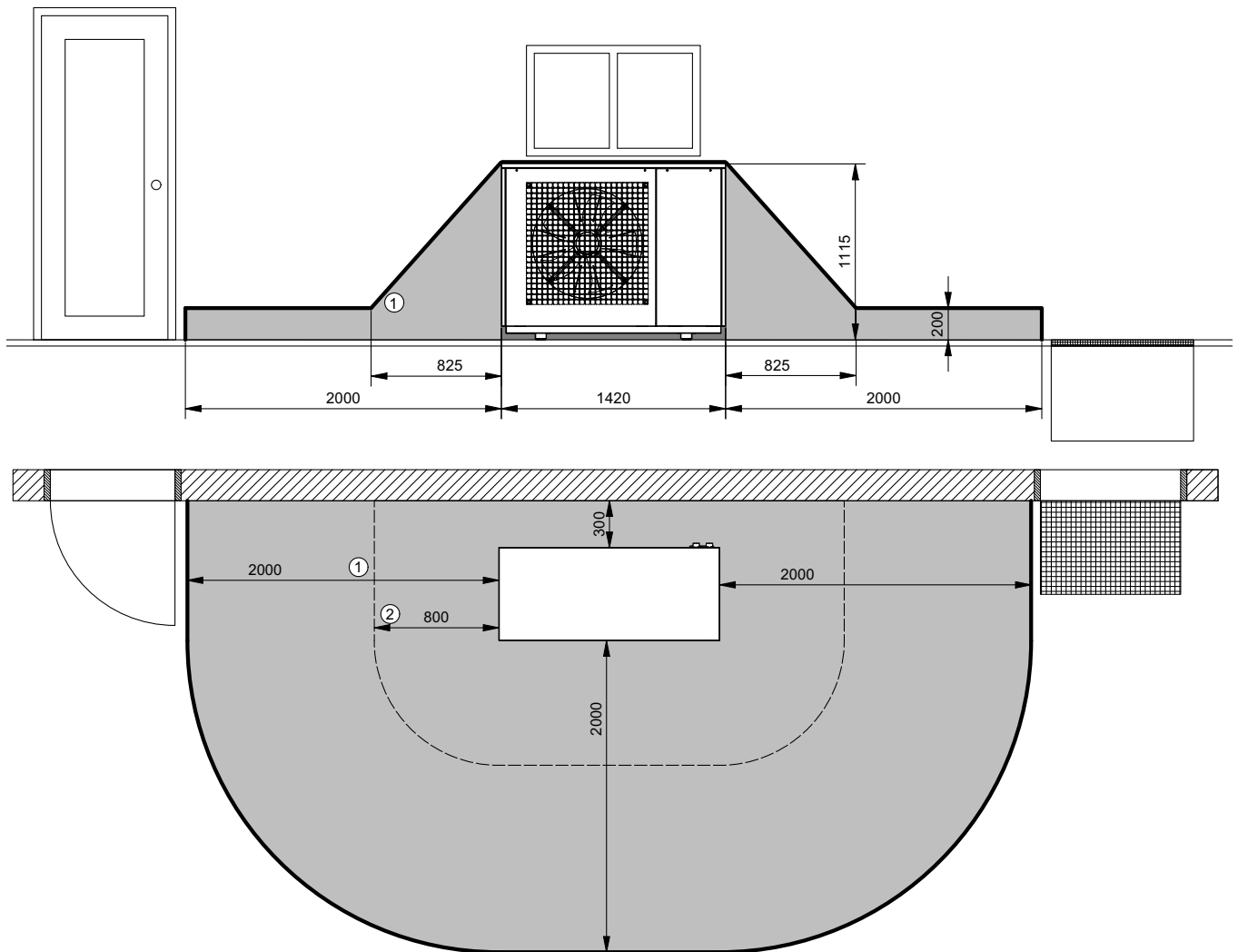

Fig. 6.4: Safety zone (floor level installation) around the heat pump

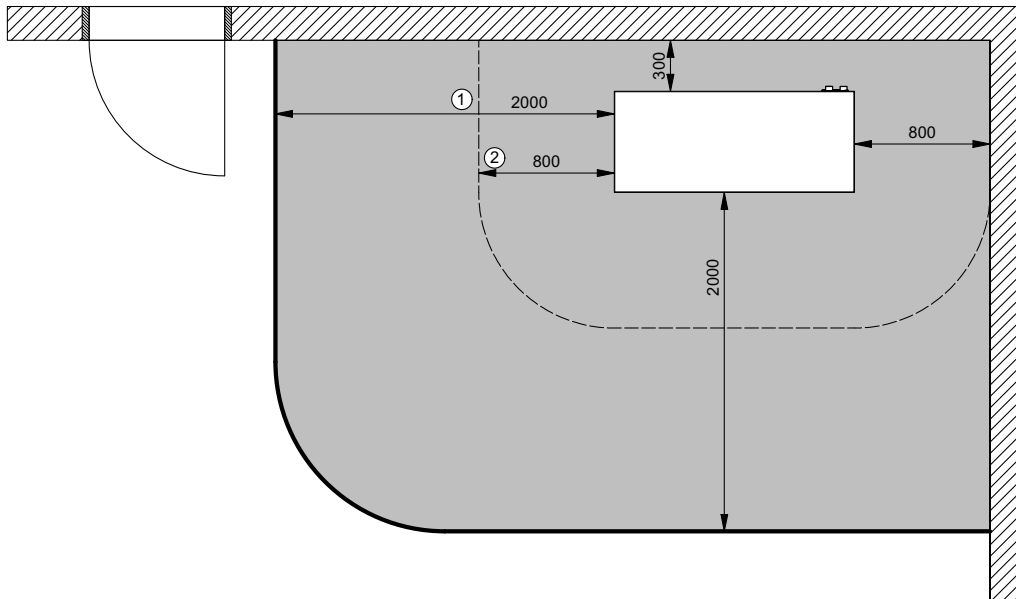

Fig. 6.5: Safety zone (floor level installation) for installation in a corner

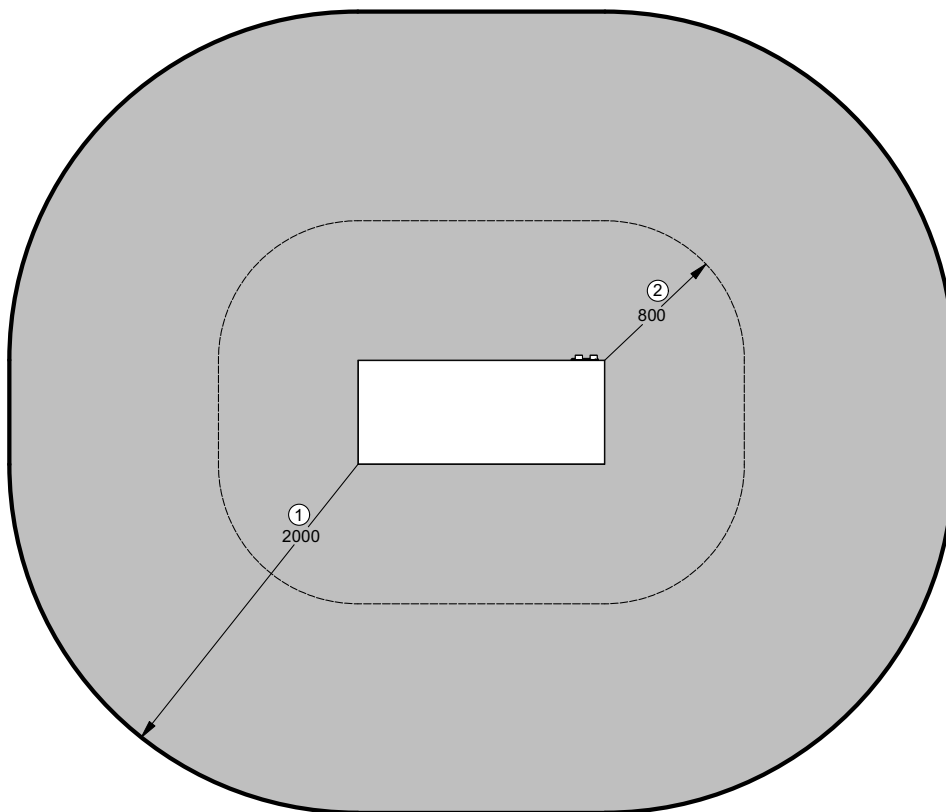

Fig. 6.6: Safety zone (floor level installation) for installation in open space

## 6.5 Condensate pipe for heat pumps with flammable refrigerant

Frost-free condensate discharge must be guaranteed. To ensure proper drainage, the heat pump must stand horizontally.

### **i** NOTE

The frost line ④ may vary according to the climatic region. The regulations of the countries in question must be observed.

#### Version 1

The condensate, which accumulates during operation, must be drained vertically into a base filled with gravel. A daily seepage capacity of at least 1.5 litres per kW heat output of the heat pump shall be provided and the diameter of the condensate water pipe should be at least 50 mm.

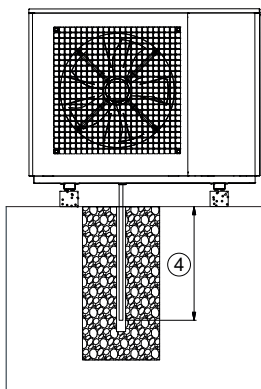

Fig. 6.7: Condensate drain in gravel

### **i** NOTE

The condensate water pipe must be installed vertically to prevent it from freezing in winter. If the condensate pipe is exposed to frost, trace heating must be provided.

#### Version 2

The condensate is channelled into a sewer, rainwater or drainage channel via a condensate pipe in the ground. The condensate pipe contains a siphon below the frost line ④. The water level in the siphon prevents the refrigerant from getting into the channel if there is a leakage. Pumping systems are impermissible! The siphon must have a minimum sealing liquid level of 300 mm.

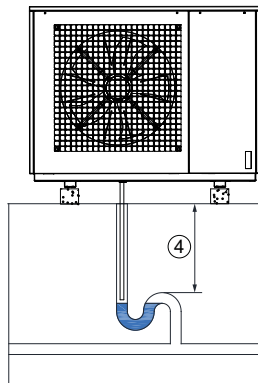

Fig. 6.8: Condensate pipe in channel over siphon

#### Version 3

Free discharge is only advisable in climate zones with short frost periods. In colder climate zones, the condensate pipe in areas at risk from frost must be fitted with a suitably dimensioned and regulated electrical trace heating on the insulated condensate pipe.

#### Version 4

The condensate pipe may lead into the building. The wall opening must be air tight. Inside the building, the pipe connection to the waste water pipe must be equipped with a siphon. The siphon must be protected against drying out. If this is not possible, a siphon that closes when it runs dry must be fitted. Lifting units are not permitted.



## 7 Assembly

### 7.1 General

The following connections need to be established on the heat pump:

- Heating system flows and returns
- Condensate drain
- Communication line to the heat pump manager (controller -N1)
- Power supplies (load/control voltage)

#### **i** NOTE

When setting up and installing the heat pump system, it must be ensured that the heat pump casing is intact and any tampering with the heat pump casing must be refrained from. In particular, misuse of the heat pump casing (e.g. as a mounting or similar) must be prevented.

#### **!** DANGER!

Risk of death due to lightning.  
Standing outside during a storm can result in a risk of death.

- ▶ Do not stand in the immediate vicinity of the heat pump.

#### **!** DANGER!

Risk of death due to electric shock.  
There is a risk of death when working on the electrical equipment or live components in wet weather conditions (precipitation, snow).

- ▶ In case of precipitation, the device must be properly closed.

#### **!** WARNING!

Risk of injury.  
When working on the device without protective equipment, injuries can occur, e.g. cuts.

- ▶ Use of personal protective equipment (PPE) in accordance with DGUV regulation 100-500 Chap. 2.35
- ▶ Personal protective equipment consisting of safety gloves, safety shoes, safety glasses and long clothing that fully covers the body.

## 7.2 Opening the covering panels

### 7.2.1 Opening the grid panels

Removing the grid panels on the front and rear:

- Loosen the screws at the top of the corresponding panel (1).
- Tilt the upper panel approx. 30° forwards (2)
- Pull the panel diagonally upwards out of the pedestal (3)

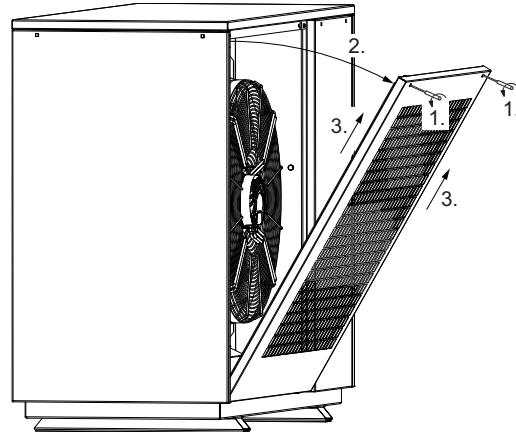

Fig. 7.1: Opening the grid panels

### 7.2.2 Opening the side covering panels

Removing the side covering panels:

- Loosen the screws at the top of the corresponding panel (1)
- Tilt the upper panel approx. 30° forwards (2)

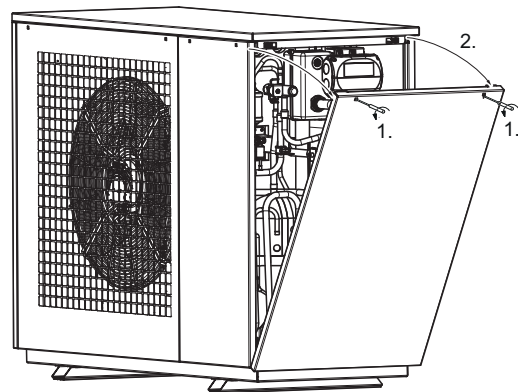

Fig. 7.2: Opening the side covering panels, work step 1 and 2

- In the tilted position, slide the panel approx. 40 mm to the right as far as it will go (3)

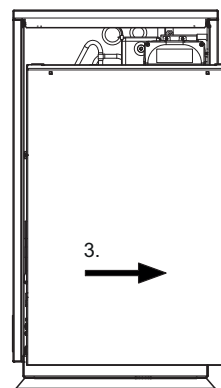

Fig. 7.3: Opening the side covering panels, work step 3

- In this position, pull the panel diagonally upwards out of the pedestal (4)

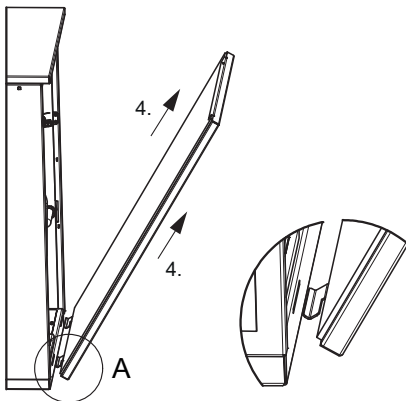

Fig. 7.4: Opening the side covering panels, work step 4

### 7.2.3 Opening the machine room covering panels

Removing the machine room front and rear panel:

- Loosen the screws at the top of the corresponding panel (1)
- Tilt the upper panel approx. 55° forwards (2) to enable it to be pushed past the profiles of the adjacent side panels.

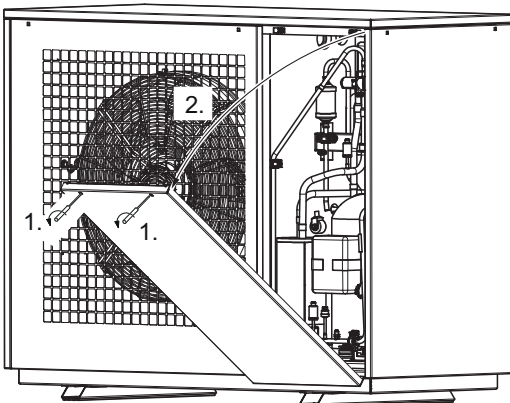

Fig. 7.5: Opening the machine room covering panels, work step 1 and 2

- In the tilted position, slide the panel approx. 40 mm to the right as far as it will go (3) (see Fig. 7.3)
- In this position, pull the panel diagonally upwards out of the pedestal (4) (see Fig. 7.4)

### 7.2.4 Opening the inspection cover

To access the space between the evaporator and the fan:

- Remove the grid panel on the fan side (see Chap. 7.2.1 on page 15)
- Loosen and remove the screw-in blind rivets with a screwdriver.

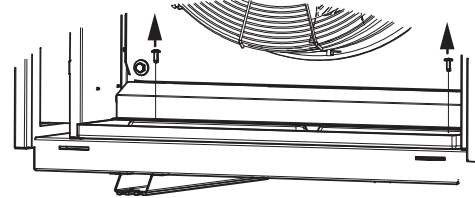

- Remove the cable cover plate

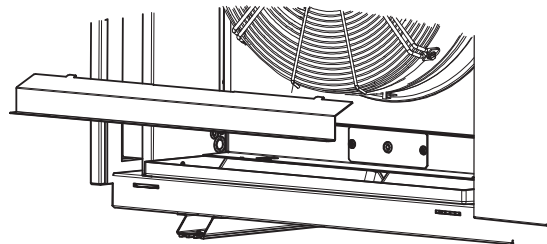

- Loosen and remove the screw-in blind rivets. Remove the inspection cover

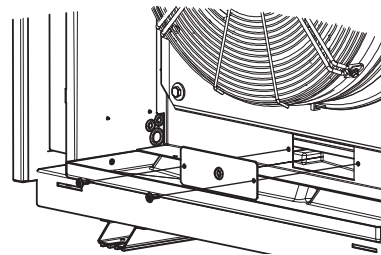

### 7.3 Connection on heating side

Refer to the device information for the connection sizes.

After the heat pump has been installed, the ductwork must be sealed so that the connection is gas-tight.

#### **CAUTION!**

**If the heating system is not flushed, impurities, sealing material residue or similar can cause damage to the liquefier and thus result in total failure.**

- ▶ **Flush the heating system adequately prior to connecting the heat pump.**

Once the heat pump has been connected to the heating system, it must be filled, purged and pressure-tested.

The tightness of the hydraulic circuit must be ensured.

#### **NOTE**

**Pump units with check valves maintain the specified flow direction. If there is incorrect distribution or breaking off of the volume flow, these units (and the check valves in particular) must be checked! The use of check valves is mandatory in the event of several heating circuits or parallel connections for heat pumps in order to avoid incorrect distribution.**

## 7.4 Water quality in heating systems

### 7.4.1 Scale formation

Scale formation in heating systems cannot be avoided, but in systems with flow temperatures below 60 °C the problem is so small that it is negligible. With high-temperature heat pumps and in particular with bivalent systems in the higher performance range (heat pump + boiler combination), flow temperatures of 60°C and more can be achieved. One preferred method for preventing scale formation is softening because this permanently removes alkaline earths (calcium and magnesium ions) from the heating system.

The following values for water quality in heating water and cold water must be observed and checked during an on-site check:

- Degree of hardness
- Conductivity
- pH value
- Filterable materials

The following (limit) values must absolutely be observed:

- Maximum degree of hardness of filling water and supplementary water 3 dGH.
- The conductivity of demineralised water (DM water) (low-salt) may not be greater than 100 µS/cm.
- The conductivity of partially demineralised water (saline) may not be greater than 1500 µS/cm.
- The pH value must be between 7.5 and 9.
- The limit value for filterable materials in heating water is < 30 mg/l.

If necessary, for example in bivalent systems, the specifications listed in the table below must also be observed, or the precise guidelines for filling water and supplementary water and the total hardness must be taken from the table in accordance with VDI 2035 – Sheet 1.

#### **i** NOTE

**The specific volumes of a heating system must be determined before filling the system.**

The saturation index SI is used to determine whether water has a tendency towards lime dissolution or lime separation. This shows whether the pH value corresponds to a neutral pH point or by how much it undershoots it due to excess acid or by how much it exceeds it due to carbonic acid deficit. At a saturation index below 0, the water is aggressive and will tend towards corrosion. At a saturation index above 0, the water is calcareous.

The saturation index SI should be between  $-0.2 < 0 < 0.2$

Filling and supplementary water as well as heating water, depending on heat output			
Overall heat output in kW	Total alkaline earths in mol/m <sup>3</sup> (total hardness in dGH)		
	≤ 20	> 20 to ≤ 50	> 50
	Specific system volume in l/kW Heat output <sup>1</sup>		
≤ 50 Specific water content heat generator > 0.3 k per kW <sup>2</sup>	none	≤ 3.0 (16.8)	< 0.05 (0.3)
≤ 50 Specific water content heat generator > 0.3 k per kW <sup>2</sup> (e.g. circulation water heaters) and systems with electrical heating elements	≤ 3.0 (16.8)	≤ 1.5 (8.4)	
> 50 kW to ≤ 200 kW	≤ 2.0 (11.2)	≤ 1.0 (5.6)	
> 200 kW to ≤ 600 kW	≤ 1.5 (8.4)	< 0.05 (0.3)	
> 600 kW	< 0.05 (0.3)	< 0.05 (0.3)	
Heating water, depending on heating output			
Operating mode	Electrical conductivity in µS/cm		
Low-salt <sup>3</sup>	> 10 to ≤ 100		
Containing salt	> 100 to ≤ 1500		
	Appearance		
	clear, free from sedimentary substances		

1. For the purpose of calculating the specific system volume, the smallest individual heat output is to be used for systems with several heat generators.
2. In systems with several heat generators with different specific water contents, the smallest specific water content is decisive.
3. Full softening is recommended for systems with aluminium alloys.

Fig. 7.6: Guideline values for filling and supplementary in accordance with VDI 2035

#### **!** CAUTION!

**Non-compliance with the specified limit values for the heating water can lead to damage.**

- ▶ The minimum permitted pH value of 7.5 must be observed.
- ▶ The specified limit values for water quality must be ensured.

### 7.4.2 Corrosion

The VDI 2035 standard recommends the use of partially demineralised water or demineralised water in systems with larger-than-average specific system volumes of 50 l/kW.

These measures (e.g. pH stabilizers) are implemented to set the pH value of the heating water to minimise the risk of corrosion in the heat pump and in the heating system.

Irrespective of the legal requirements, the following limit values in the heating water used for various substances must not be undershot or exceeded. This is to ensure safe operation of the heat pump. A water analysis must be carried out before commissioning the system. If the water analysis produces a "-" for a maximum of one indicator or a "o" for a maximum of two indicators, the analysis must be classed as negative.

Evaluation characteristic	Concentration range (mg/l or ppm)	Stainless steel	Copper
Bicarbonate (HCO <sub>3</sub> )	< 70	+	o
	70 - 300	+	+
	> 300	+	o/+
Sulphate (SO <sub>4</sub> <sup>2-</sup> )	< 70	+	+
	70 - 300	+	o/-
	> 300	o	-
Hydrogen carbonate HCO <sub>3</sub> <sup>-</sup> / SO <sub>4</sub> <sup>2-</sup>	> 1.0	+	+
	< 1.0	+	o/-
Electrical conductivity	< 10 µS/cm	+	o
	10 - 500 µS/cm	+	+
	> 500 µS/cm	+	o
pH value	< 6.0	o	o
	6.0 - 7.5	o/+	o
	7.5 - 9.0	+	+
	> 9.0	+	o
Ammonium (NH <sub>4</sub> <sup>+</sup> )	< 2	+	+
	2 - 200	+	o
	> 200	+	-
Chloride ions (Cl <sup>-</sup> )	< 150	+	+
	> 150	o	o/+
Chlorine (Cl <sub>2</sub> )	< 0.5	+	+
	1 - 5	+	o
	> 5	o/+	o/-
Hydrogen sulphide (H <sub>2</sub> S)	< 0.05	+	+
	> 0.05	+	o/-
Carbon dioxide (CO <sub>2</sub> )	< 5	+	+
	5 - 20	+	o
	> 20	+	-
Nitrate (NO <sub>3</sub> )	< 100	+	+
	> 100	+	o
Iron (Fe)	< 0.2	+	+
	> 0.2	+	o
Aluminium (Al)	< 0.2	+	+
	> 0.2	+	o
Manganese (Mn)	< 0.1	+	+
	> 0.1	+	o
Saturation Index	> -0.2	+	+
	< 0.2	+	+

Fig. 7.7: Limit values for the quality of heating water

Resistance of copper-soldered or welded stainless-steel plate heat exchangers to the substances present in water:

#### Notes

- "+" = Normally good resistance
- "o" = Corrosion problems may arise, particularly if several factors receive an evaluation of "o"
- "-" = Should not be used

#### **i** NOTE

The water quality should be checked again after 4 to 6 weeks, as the quality could change during the first few weeks of operation due to chemical reactions.

### Important!

The notes/settings in the instructions of the heat pump manager must always be observed and carried out accordingly; not doing so will lead to malfunctions. The maximum water outlet temperature must not exceed 65°C and must be secured on the system side so that, if the temperature is exceeded, all additional heat sources are switched off safely.

### Minimum and maximum heating water flow rate

The minimum heating water flow rate through the heat pump must be assured in all operating statuses of the heating system. For example, this can be accomplished by installing a dual differential pressureless manifold.

The maximum flow rate must not be exceeded.

The specified nominal flow rate (Chap. 13 on page 26) must be assured in all operating states. A built-in flow rate sensor monitors the necessary minimum flow rate.

### Frost protection

On heat pump systems where protection from frost cannot be guaranteed, there must be an option for draining the system (see figure). The frost protection function of the heat pump manager is active whenever the heat pump manager and the heat circulating pump are ready for operation. The system must be drained if the heat pump is taken out of service or in the event of a power failure.

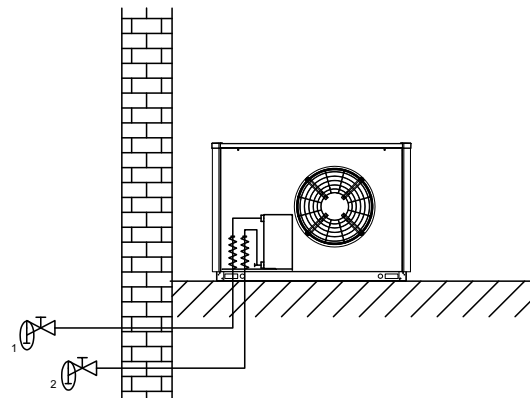

## 7.5 Temperature sensor

The following temperature sensors are already installed or must be installed additionally:

- Outside temperature (R1; NTC-2) is supplied with the heat pump manager.
- Secondary circuit return temperature (R2; NTC-10) installed
- Flow rate monitoring (- R3.1; PT1000) installed

### 7.5.1 Sensor characteristic curves

The temperature sensors (NTC-10) to be connected to the heat pump manager (controller -N1) must correspond to the sensor characteristic curve illustrated in Fig. 7.8 on page 19. The only exception is the outside temperature sensor included in the scope of supply of the heat pump (NTC-2) (see Fig. 7.9 on page 19)

Temp. in °C	NTC-2 in kΩ	NTC-10 in kΩ	PT 1000 in kΩ
-20	14.6	67.7	0.92
-15	11.4	53.4	0.94
-10	8.9	42.3	0.96
-5	7.01	33.9	0.98
0	5.6	27.3	1.0
5	4.5	22.1	1.02
10	3.7	18.0	1.04
15	2.9	14.9	1.06
20	2.4	12.1	1.08
25	2.0	10.0	1.10
30	1.7	8.4	1.12
35	1.4	7.0	1.14
40	1.1	5.9	1.16
45	1.0	5.0	1.17
50	0.8	4.2	1.19
55	0.7	3.6	1.21
60	0.6	3.1	1.23
70			1.27
80			1.31
90			1.35
100			1.39
110			1.42
120			1.46
130			1.50
140			1.54

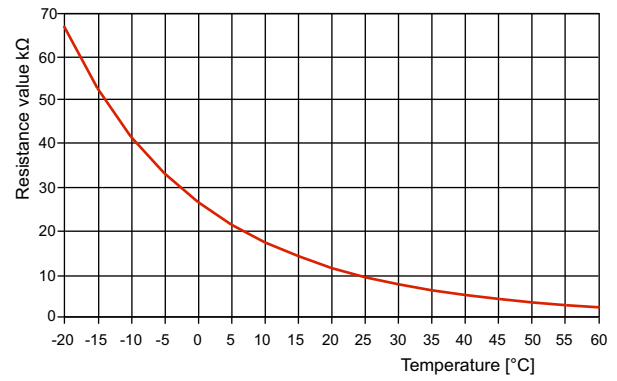

Fig. 7.8: Sensor characteristic curve NTC-10

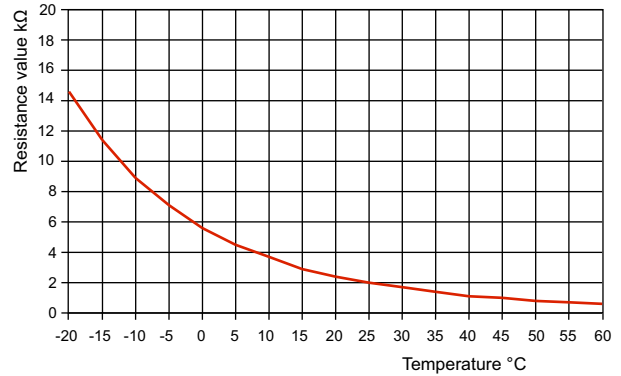

Fig. 7.9: Sensor characteristic curve NTC-2 according to DIN 50350 Outside temperature sensor

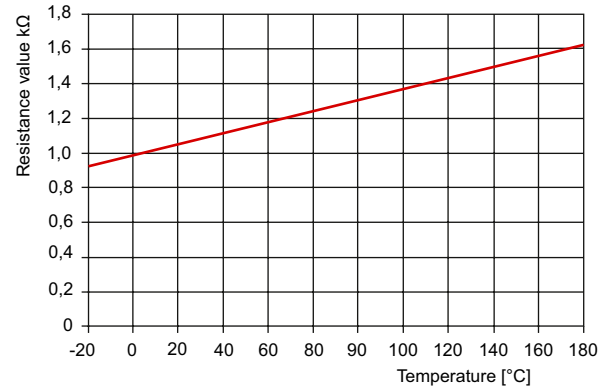

Fig. 7.10: Sensor characteristic curve PT 1000

## 7.6 Electrical connection

### 7.6.1 General

All electrical installation work must be carried out by a trained electrician or a specialist for the specified tasks in accordance with the

- installation and operating instructions
- country-specific installation regulations (e.g. VDE 0100),
- technical connection conditions of the energy suppliers and supply grid operators (e.g. TAB) and
- local conditions.

To ensure that the frost protection function of the heat pump works properly, the heat pump manager can only be briefly disconnected from the power supply and the flow must be maintained through the heat pump.

All supply cables on the heat pump must be fed into the connection socket through the designated free cable glands. The cables must be secured with strain relief.

### 7.6.2 Electrical installation work

3 lines/cables must be routed to the heat pump in total:

- The heat pump is connected to the power using a commercially available 5-wire cable.  
The cable must be provided on-site. The line cross section is selected in accordance with the power consumption of the heat pump (see attachment Device Information) and the applicable VDE (EN) and VNB regulations. All pole disconnection with minimum 3 mm contact gap (e.g. utility company blocking contactor, power contactor) must be fitted in the power supply for the heat pump.  
A 3-pole circuit breaker with common tripping of all phase conductors (tripping current according to Device Information) provides short-circuit protection, taking into consideration the design of the internal wiring.  
The relevant components in the heat pump receive internal overload protection.  
The clockwise rotating field of the load supply must be ensured when connecting.  
Phase sequence: L1, L2, L3.
- The control voltage is supplied via the heat pump manager (controller -N1).  
To this end, a 3-pole cable should be routed as shown in the electrical documentation. Further information on the wiring of the heat pump manager is available in the heat pump manager operating instructions.
- A shielded communication line (J-Y(ST)Y ..LG) (not included in the scope of supply) connects the heat pump manager (controller -N1) with the refrigerant circuit controller -N0 installed in the heat pump. More detailed instructions can be found in the heat pump manager operating instructions and in the electrical documentation.

#### **i** NOTE

**The communication cable is necessary for the function of air-to-water heat pumps in outdoor installation. It must be shielded and laid separately from the mains cable**

### 7.6.3 Demand sensor connection

The demand sensor R2.2 (NTC 10) is included with the heat pump manager (controller -N1). It must be installed depending on the hydraulics used (see cap. 17 on page 38).

If a demand sensor is not connected, the second heat generator cannot be controlled with the heat pump manager in the event of an interruption in communication either.

#### **i** NOTE

**The return sensor R2 installed in the heat pump is active when the compressor is running and must not be disconnected.**

#### **i** NOTE

**Sensor cables can be extended up to 50 m with 2 x 0.75 mm cables.**

### 7.6.4 High-performance circulating pump connection

In many cases, the supply voltage of the pump is stuck on continuous current when using larger electronically controlled circulating pumps (the manufacturer's information on the pump being used should be taken into consideration). The pump is then generally actuated using the Start/Stop input. This input is operated with extra low voltage from the pump (a link cable is usually inserted in the factory default of the pump). In order to be able to actuate the input, a coupling relay with a floating contact is required. This must be controlled with the pump function of a 230 V relay output of the controller. Due to the extra low voltage to be switched, a suitable relay with the appropriate contact material (gilded) must be selected and integrated on-site.

### 7.6.5 Frost protection

Regardless of the settings for the heat circulating pumps, they always run in heating, defrost and frost protection mode. In systems with multiple heating circuits, the 2nd and 3rd heat circulating pump has the same function.

#### **⚠ CAUTION!**

**Risk of damage.**

**When the heat pump manager has no voltage, there is no longer any flow through the heat pump and damage can occur due to frost.**

- ▶ **To ensure the frost protection function on the heat pump, do not disconnect the heat pump manager from the voltage.**
- ▶ **The primary pump M11, the secondary pump M16 and, if necessary, the heat circulating pump M13 may only be clamped onto the heat pump manager.**

## 8 Commissioning

### 8.1 General

Commissioning must be carried out by trained personnel. Specialist tools must be used. To ensure that commissioning is performed correctly, it should only be carried out by an after-sales service technician authorised by the manufacturer (Fig. 1.1 on page 4). Under certain conditions, this may be associated with an additional warranty service.

#### **WARNING!**

**Risk of injury and damage to property due to improper handling.**

- ▶ **Work on the heat pump is only to be carried out by people with the knowledge set out in Fig. 1.1 on page 4.**

### 8.2 Preparation

The following items must be checked prior to commissioning:

- The casing covers of the heat pump must be mounted on all sides.
- There must be no ignition sources and fire loads in the safety zone.
- Personal protective equipment (e.g. protective goggles, safety shoes and gloves where necessary) must be used when working on the device.
- All of the heat pump connections must be installed as described in chapter 7.
- The heating circuit must have been filled and checked.
- All valves which could impair the proper flow in the heating circuit must be open.
- The air intake and air outlet paths must be clear.
- The settings on the heat pump manager (controller -N1) must be adapted to the heating system in accordance with the operating instructions.
- Ensure that the condensate drain functions properly.
- The hydraulic network must be flushed correctly before installing the heat pump. This includes the supply line to the heat pump. Only when flushing is complete can the heat pump be hydraulically integrated.
- The dirt traps present as standard or included for assembly must be inspected between 4 and 8 weeks after the heat pump is commissioned or changes made to the heating system and cleaned if necessary. Additional maintenance intervals must be scheduled depending on the level of soiling, and must be defined and carried out by a suitably qualified person. Unless there is an excessive accumulation of dirt, an interval of 1 year is generally effective.

#### **Special notes for integration of heat pumps into existing systems (renovations):**

The existing heat distribution network (pipe materials, connection types, etc.) and the existing heating systems (e.g. radiators, underfloor heating, etc.) can impact the quality of the water in existing systems. Particularly when welded steel pipes or pipes that are not oxygen diffusion-proof are used, deposits, scaling, silting or similar may be present that can cause damage in the heat pump system. This can result in a total failure of the heat pump. The following measures must be observed to avoid this:

- Compliance with the water properties and water quality
- Flushing of the hydraulic system
- Maintenance interval of the dirt traps
- If silting or ferromagnetic particles are to be expected in the hydraulic network, dirt separators or magnetite separators must be installed on-site before the medium enters the heat pump. The cleaning intervals must be defined by a suitably qualified person.
- It is essential to ensure that no oxygen gets into the heating circuit of the heat pump.

### 8.3 Procedure

#### **NOTE**

**Only software that is authorised and approved by the manufacturer can be installed on the machine's control system.**

The heat pump is commissioned via the heat pump manager (controller -N1). The settings must be completed in accordance with the instructions.

At heating water temperatures lower than 7 °C, commissioning is not possible. The water in the buffer tank must be heated to at least 20 °C with the 2nd heat generator.

The following procedure must then be followed to ensure problem-free commissioning:

- 1) Close all consumer circuits.
- 2) Ensure that the heat pump has the correct water flow.
- 3) Use the manager to select the "winter" operating mode.
- 4) In the special functions menu, start the "Commissioning" program.
- 5) Wait until a return temperature of at least 29 °C has been reached.
- 6) Now slowly reopen the heating circuit valves in succession so that the heating water flow rate is constantly raised by slightly opening the respective heating circuit. The heating water temperature in the buffer tank must not be allowed to drop below 24 °C during this process. This ensures that the heat pump can be defrosted at any time.
- 7) When all heating circuits are fully open and a return temperature of at least 20 °C is maintained, the commissioning is complete.

## 9 Cleaning work

### 9.1 General

Regular cleaning of the system ensures continuous efficient and fault-free operation.

#### **WARNING!**

**Risk of injury and damage to property due to improper handling.**

- ▶ **Work on the heat pump is only to be carried out by people with the knowledge set out in Fig. 1.1 on page 4.**

#### **DANGER!**

**Risk of death due to fire and explosion. If there is a leakage of the propane refrigerant due to a fault, an ignitable atmosphere can form.**

- ▶ **Avoid ignition sources and fire loads in the safety zone.**
- ▶ **Keep the casing closed.**

To protect the paintwork, avoid leaning anything against the device or putting objects on the device. The outdoor components of the heat pump can be wiped with a damp cloth and commercially available domestic cleaner.

#### **NOTE**

**Never use cleaning agents containing sand, soda, acid or chloride, as these can damage the surfaces.**

#### **NOTE**

**Only genuine spare parts may be used.**

#### **CAUTION!**

**Leakage from the hydraulic circuit can result in damage.**

- ▶ **Continuous sealing of the entire hydraulic network must be ensured.**

### 9.2 Cleaning the heating system

#### **CAUTION!**

**A clogged dirt trap can result in malfunctions or damage.**

- ▶ **The installed dirt traps must be cleaned at regular intervals as required.**

The cleaning intervals should be chosen according to the degree of soiling in the system itself. The filter insert and any sludge or magnetite separator must be cleaned.

For cleaning, the heating circuit must be made pressureless in the vicinity of the dirt trap, the filter compartment unscrewed, and the filter insert removed and cleaned.

Assembly carried out in reverse order requires attention to correct assembly of the screen insert and tightness of the screw joints.

The ingress of oxygen into the heating water circuit may result in the formation of oxidation products (rust), particularly if steel components are used. These enter the heating system via the valves, the circulating pumps and/or plastic pipes. A diffusion-resistant installation is therefore essential, especially with regard to the complete piping.

Residue from lubricants and sealants may also contaminate the heating water.

In the event of severe contamination leading to a reduction in the performance of the liquefier in the heat pump, the system must be cleaned by a heating technician.

Based on current information, we recommend using a 5% phosphoric acid solution for cleaning purposes. If cleaning needs to be performed more frequently, a 5% formic acid solution should be used.

In both cases, the cleaning fluid should be at room temperature. We recommend flushing the heat exchanger in the direction opposite to the normal flow direction.

To prevent acidic cleaning agents from entering the heating system circuit, we recommend connecting the flushing device directly to the flow and return of the liquefier of the heat pump.

It is then important that the system be thoroughly flushed using appropriate neutralising agents to prevent any damage from being caused by cleaning agent residue remaining in the system.

Acids must be used with care and the regulations of the employers liability insurance associations must be adhered to.

The instructions of the cleaning agent manufacturer must always be observed.

### 9.3 Cleaning the air system

The evaporator, ventilator and condensate drain should be cleaned of contamination (leaves, twigs, etc.) as required.

The grid panels on the heat pump see Chap. 7.2.1 on page 15 must be removed for this purpose. The inspection opening should also be used for cleaning the condensate drain or the condensate hose.

The side panel parts and the inspection opening are removed and fitted as described in Cap. 7.2.4 on page 16.

#### **DANGER!**

**Risk of death due to fire and explosion. Using sharp and hard objects to clean the evaporator and the condensate tray can result in damage to the refrigeration circuit. Leaked refrigerant can form an ignitable atmosphere.**

- ▶ **Do not use sharp or hard objects for cleaning the evaporator and the condensate tray.**



## 10 Care

- To protect the paintwork, avoid leaning anything against the device or putting objects on the device.
- The outdoor components of the heat pump can be wiped with a damp cloth and commercially available domestic cleaner.

### **i** NOTE

**Never use cleaning agents containing sand, soda, acid or chloride, as these can damage the surfaces.**

- Under extreme weather conditions (e.g. snow drifts), ice formation may occur on the air intake and air outlet grids. If this happens, the ice must be removed from the vicinity of the intake and air outlet area to ensure that the minimum air flow is maintained.
- Twigs, leaves and dirt accumulated around the device must be removed at regular intervals.

## 11 Faults/troubleshooting/repair

This heat pump is a quality product and is designed for trouble-free operation. In the unlikely event that a fault should occur, please inform the responsible after-sales service.

### **!** DANGER!

**Risk of death due to fire or explosion.**

The device contains flammable odourless refrigerant (R290). In case of leakage, the refrigerant can mix with the ambient air and form a flammable atmosphere.

- ▶ **Work on the heat pump is only to be carried out by people with the knowledge set out in Fig. 1.1 on page 4.**
- ▶ **Avoid ignition sources (naked flames, hot surfaces, electrical equipment with ignition sources and static discharge) and fire loads in the danger zone.**
- ▶ **Before and when opening the device, check the working area and the interior of the device for the presence of R290 using the refrigerant detector. The detector and all other tools must be suitable for the R290 refrigerant, produce no sparks and must be appropriate sealed or explosion protected and calibrated.**
- ▶ **Cordon off the area around the device to prevent unauthorised access.**
- ▶ **The leakage tightness of the refrigerant circuit must be tested after all assembly work is complete and the external power supply (load and control voltage) has been connected.**

### **!** DANGER!

**Risk of death due to electric shock.**

If the device is not fitted with all covering panels there is a risk of electric shock.

- ▶ **Disconnect all electric circuits from the power source prior to opening the device.**
- ▶ **After disconnecting the power supply, you have to wait 5 minutes before all components are de-energised.**

### **!** DANGER!

**Risk of death due to lightning.**

Standing outside during a storm can result in a risk of death.

- ▶ **Do not stand in the immediate vicinity of the heat pump.**

### **!** DANGER!

**Risk of death due to electric shock.**

There is a risk of death when working on the electrical equipment or live components in wet weather conditions (precipitation, snow)

- ▶ **In case of precipitation, the device must be properly closed.**

### **i** NOTE

Only software that is authorised and approved by the manufacturer can be installed on the machine's control system.

The following steps must be adhered to before starting the work

- 1) Before starting the work, ensure that the power supply to the device is disconnected externally. The earth connection must be guaranteed. After disconnecting the power supply, you have to wait 5 minutes before all components are de-energised.
- 2) The refrigeration circuit must not be damaged.
- 3) Before and when opening the device, check the working area and the interior of the device for the presence of R290 using the refrigerant detector.

Anyone carrying out work on the refrigeration circuit must be certified to safely handle flammable refrigerants or be supervised by a person with such certification.

If there is a risk of refrigerant escaping during repair work, a mobile ventilation (ex-proof fan) can be used as a supporting or even essential measure.

Before starting the repair work on the relevant component, the paint protector must be checked to ensure it is in the original state. Paint protectors that have to be removed for the repair work must be mounted again once the work is complete.

If soldering or welding work has to be carried out, an appropriate fire extinguisher must be in the immediate vicinity. A CO<sub>2</sub> or powder extinguisher must also be available in the location where the device is filled with refrigerant.

### **DANGER!**

**Risk of death due to fire or explosion.**

**The device contains flammable refrigerant (R290). In case of leakage, the refrigerant can mix with the ambient air and form a flammable atmosphere.**

- ▶ **Work on the heat pump is only to be carried out by people with the knowledge set out in Fig. 1.1 on page 4.**
- ▶ **Avoid ignition sources (naked flames, hot surfaces, electrical equipment with ignition sources and static discharge) and fire loads in the danger zone.**
- ▶ **Before and when opening the device, check the working area and the interior of the device for the presence of R290 using the refrigerant detector.**
- ▶ **Cordon off the area around the device to prevent unauthorised access.**

To prevent excessive leakage of refrigerant when connecting hoses to the refrigeration circuit and sealing them, it is useful to use a quick opening refrigerant Schrader valve.

### **CAUTION!**

**Leakage from the hydraulic circuit can result in damage.**

- ▶ **Continuous sealing of the entire hydraulic network must be ensured.**

Check that the wiring is not exposed to any wear, corrosion, tension, vibrations, sharp edges and other unfavourable environmental influences. The check must also take into account the effects of ageing.

If the high pressure switch has been replaced, correct functioning must be ensured during the leakage tightness test with nitrogen.

## 11.1 Refrigerant handling

(removal and filling)

### **Always proceed as follows before opening the refrigeration circuit:**

If possible, siphon off the refrigerant using suitable equipment and collect it in approved recycling bottles. All personnel must be trained in handling recycling bottles for R290. Handling recycling bottles as well as their return/disposal must comply with the safety rules, in this respect refer to the information supplied by the recycling system's operator. If it is not possible to siphon and recycle, the refrigerant may alternatively be drained through a hose into a safe zone containing no ignition sources, windows, doors, ventilation openings, light wells, sewer system openings or similar.

Additionally, a suitable fan (Ex zone II) must be used at the hose outlet point to ensure that the refrigerant is sufficiently diluted. To achieve the fastest possible dilution of the refrigerant in the environment, it is useful to raise the outlet point as high as possible and not to position it at ground level.

The zone around the outlet point must be cordoned off and indicated by appropriate warning notices. In the fan flow direction for diluting the refrigerant, there must not be any ignition sources, windows, doors, ventilation openings, light wells, drainage openings or property boundaries.

- Start drainage of the refrigerant with the service valve on the low pressure side.
- After a few minutes, move the expansion valve to the open position using the permanent magnet.
- Then open the service valve on the high pressure side.
- When drainage / extraction is complete, adequately flush the entire device into a drainage zone with nitrogen using a drain hose.
- Evacuate to 20 mbar absolute pressure. Use vacuum pumps suitable for R290. The blower (Ex zone II) must be positioned in such a way that the vacuum pump is in the air flow.
- Then break the vacuum with nitrogen.
- If there is still refrigerant in the refrigeration circuit, repeat the evacuation and flushing work steps. This must be checked at all service valves in the refrigeration circuit.
- The refrigeration circuit must always be opened with a pipe cutter. Desoldering of components must not be carried out.
- During soldering work, flush the area with an adequate quantity of nitrogen.
- Replace the filter dryer whenever any repair work is performed on the open refrigeration circuit
- After the repair work is complete, perform the following tests before adding the refrigerant:
  - ♦ Pressure test at solder connections that have been created
  - ♦ Leakage tightness test
  - ♦ Evacuate to an absolute pressure of 2.7 mbar or lower.
- The leak detector must be suitable for the type of refrigerant being used.
- During refrigerant emptying and filling, ensure that heating water is being conveyed through the liquefier.
- Make sure that the filling fittings are not used for different refrigerants. Hoses should be as short as possible to minimise the quantity of refrigerant they contain.

- Refrigerant bottles must remain in a vertical position.
- During filling, the refrigerant bottle and the hoses must be externally ventilated using the blower (Ex zone II).
- The refrigerant bottle must not be heated with naked flames or a hot air dryer to speed up filling. This can be done using a hot water bath or heating sleeves suitable for propane bottles.
- Ensure that the refrigerant circuit is earthed before starting filling.
- Evacuate the filling hose and manifold as far as the connection point on the device before filling.  
If the manifold and the filling hose are filled with propane, check them for leaks again.
- After filling, safely drain the remaining quantity of propane in the manifold and the hoses.
- Check for leaks again after filling using the refrigerant detector. If a leakage is indicated, repeat the operation.

### CAUTION!

**Risk of damage when emptying and filling the refrigerant. When emptying and filling the refrigerant, damage can occur due to freezing.**

- ▶ **When emptying and filling the refrigerant, ensure that there is a flow through the liquefier.**

Components that have been removed can still release small quantities of refrigerant from compressor oil residue (especially the compressor itself). Do not seal or solder removed components. Store the components in the open air until the work is complete. Subsequent transportation must be in a ventilated vehicle

## 12 Decommissioning/disposal

Before the heat pump is removed, familiarise yourself with the device-specific and local conditions, disconnect the machine from the external voltage and block it hydraulically. The heat pump must be dismantled by trained personnel.

Observe all environmental requirements regarding the recovery, recycling and disposal of materials and components in accordance with all applicable standards. Particular attention should be paid to proper disposal of the refrigerant oil. Anyone carrying out work on the refrigeration circuit must be certified to safely handle flammable refrigerants or be supervised by a person with such certification.

If disposing of parts of the refrigeration circuit, particularly the compressor or the entire heat pump, the parts must be left open after removing the refrigerant, see Cap. 11.1 on page 24. Sealing by squeezing or soldering must not be carried out.

If the compressor is to be disposed of, it should be evacuated with sufficient negative pressure to remove as much dissolved refrigerant in the compressor oil as possible. The procedure for extraction or drainage of the refrigerant set out in Cap. 11 on page 23 must be followed.

### NOTE

**Devices must be marked to specify that they have been decommissioned and that the refrigerant has been removed. This marking should include the date and a signature.**

### DANGER!

**Risk of death due to lightning. Standing outside during a storm can result in a risk of death.**

- ▶ **Do not stand in the immediate vicinity of the heat pump.**

### DANGER!

**Risk of death due to electric shock. There is a risk of death when working on the electrical equipment or live components in wet weather conditions (precipitation, snow).**

- ▶ **In case of precipitation, the device must be properly closed.**

### DANGER!

**Risk of death due to electric shock. If the device is not fitted with all covering panels there is a risk of electric shock.**

- ▶ **Disconnect all electric circuits from the power source prior to opening the device.**
- ▶ **After disconnecting the power supply, you have to wait 5 minutes before all components are de-energised.**

## 13 Device information

Type and order code		LA 1118CP
<b>1 Design</b>		
Heat source		Air
1.1 Seasonal room heating energy efficiency $\eta_s$ average climate 35 °C / 55 °C		196 %/152 %
1.2 Controller		WPM
1.3 Installation location		Outside
1.4 Thermal energy metering		Integrated
1.5 Performance level		Inverter
<b>2 Operating limits</b>		
2.1 Heating water flow / return	°C	Up to 65 / Above 20
2.2 Air (heating)	°C	-22 to +35
Cooling water flow	°C	+12 to +20
Air (cooling)	°C	+15 to +45
<b>3 Flow / sound</b>		
3.1 Heating water flow / internal pressure differential		
Nominal flow in accordance with EN 14511	A7/ W35...30m <sup>3</sup> /h / Pa	0.95 / 18000
3.2 Minimum heating water flow rate	m <sup>3</sup> /h	0.95
3.3 Maximum heating / cooling water flow rate	m <sup>3</sup> /h	1.8
3.4 Minimum cooling water flow rate	m <sup>3</sup> /h	1.05
3.5 Sound power level according to EN 12102 for A7 / W55 outside Normal operation / reduced operation	dB(A)	49 / 48
3.6 Sound pressure level at distance of 10 m for A7 / W55 outside Normal operation / reduced operation	dB(A)	21 / 20
3.7 Maximum sound power level in daytime operation for A7 / W55 outside	dB(A)	59
3.8 Air flow	Normal operation / reduced operation 1m <sup>3</sup> /h	1700-5000 / 1600-4500
<b>4 Dimensions, weight and filling quantities</b>		
4.1 Device dimensions without connections	H x W x L mm	1107 x 1418 x 598
4.2 Device connections for heating	Inches	G 1 1/4" external thread
4.3 Weight of device excluding packaging	kg	213
4.4 Refrigerant/total filling weight	Type / kg	R290 / 1.3
4.5 GWP value / CO2 equivalent	--- / t	3 / 0.004
4.6 Refrigeration circuit hermetically sealed		Yes
4.7 Lubricant	Type	PZ46M
<b>5 Electrical connection</b>		
5.1 Supply voltage / fusing / RCD type		3~/N/PE 400 V (50 Hz) / C13 / B
5.2 Control voltage/fusing via WPM		1~/N/PE 230 V (50 Hz) / 6.3AT
5.3 Degree of protection according to EN 60 529		IP 24
5.4 Starting current limiter		Inverter
5.5 Rotary field monitoring		Yes
5.6 Max. consumption	kW	Max. ~5.6
5.7 Crank case heater (regulated) power consumption	W	70
5.8 Power consumption of fan	W	Max. 280
<b>6 Complies with the European safety regulations</b>		See CE declaration of conformity
<b>7 Additional model features</b>		
7.1 Type of defrosting		Reverse circulation
7.2 Condensate tray frost protection/water in device is protected from freezing		Yes
7.3 Max. operating overpressure (heat sink)	bar	6.0

Type and order code		LA 1118CP
<b>8</b>	<b>Heat output/COP</b>	
<b>8.1</b>	<b>Heat output/coefficient of performance (COP)</b>	EN 14511
	<b>Performance level</b>	Modulating
	A-10 / W35 kW / ---	10.6 / 2.7
	A-7 / W35 kW / ---	11.2 / 2.9
	A2 / W35 opt. kW / ---	4.9 / 4.6
	A2 / W35 nominal kW / ---	5.6 / 4.3
	A7 / W35 kW / ---	5.4 / 5.6
	A7 / W45 kW / ---	5.1 / 4.2
	A7 / W55 kW / ---	4.0 / 3.2
	A7 / W65 kW / ---	3.7 / 2.4
<b>8.2</b>	<b>Cooling capacity / coefficient of performance (COP)</b>	EN 14511
	A35 / W18 opt. kW / ---	4.6 / 4.0
	A35 / W18 nominal kW / ---	5.9 / 3.6
	A35 / W18 max kW / ---	8.0 / 2.9

1. In reduced operation, the heat output and the efficiency are reduced.

# 14 Product information as per Regulation (EU) No 813/ 2013, Annex II, Table 2

Information requirements for heat pump space heaters and heat pump combination heaters							
Model	LA 1118CP						
Air-to-water heat pump	yes						
Water-to-water heat pump	no						
Brine-to-water heat pump	no						
Low-temperature heat pump	no						
Equipped with a supplementary heater	no						
Heat pump combination heater	no						
Parameters shall be declared for medium-temperature application, except for low-temperature heat pumps. For low-temperature heat pumps, parameters shall be declared for low-temperature application.							
Parameters shall be declared for average climate conditions:							
Item	Symbol	Value	Unit	Item	Symbol	Value	Unit
<b>Rated heat output (*)</b>	$P_{rated}$	9	kW	<b>Seasonal space heating energy efficiency</b>	$\eta_s$	152	%
Declared capacity for heating for part load at indoor temperature 20°C and outdoor temperature $T_j$				Declared coefficient of performance or primary energy ratio for part load at indoor temperature 20 °C and outdoor temperature $T_j$			
$T_j = -7^\circ\text{C}$	$P_{dh}$	8,4	kW	$T_j = -7^\circ\text{C}$	$COP_d$	2,28	-
$T_j = +2^\circ\text{C}$	$P_{dh}$	5,1	kW	$T_j = +2^\circ\text{C}$	$COP_d$	3,91	-
$T_j = +7^\circ\text{C}$	$P_{dh}$	4,6	kW	$T_j = +7^\circ\text{C}$	$COP_d$	5,21	-
$T_j = +12^\circ\text{C}$	$P_{dh}$	5,2	kW	$T_j = +12^\circ\text{C}$	$COP_d$	6,81	-
$T_j = \text{bivalent temperature}$	$P_{dh}$	9,4	kW	$T_j = \text{bivalent temperature}$	$COP_d$	2,28	-
$T_j = \text{operation limit temperature}$	$P_{dh}$	9,4	kW	$T_j = \text{operation limit temperature}$	$COP_d$	2,28	-
For air-to-water heat pumps				For air-to-water heat pumps:			
$T_j = -15^\circ\text{C}$ (if TOL < $-20^\circ\text{C}$ )	$P_{dh}$	0,0	kW	$T_j = -15^\circ\text{C}$ (if TOL < $-20^\circ\text{C}$ )	$COP_d$	0,00	-
Bivalent temperature	$T_{biv}$	-10	°C	For air-to-water heat pumps: Operation limit temperature	TOL	-10	°C
Cycling interval capacity for heating	$P_{cyc}$	-	kW	Cycling interval efficiency	$COP_{cyc}$	-	-
Degradation co-efficient (**)	$C_{dh}$	0,94	-	Heating water operating limit temperature	WTOL	65	°C
Power consumption in modes other than active mode				Supplementary heater			
Off mode	$P_{OFF}$	0,050	kW	Rated heat output (*)	$P_{sup}$	0	kW
Thermostat-off mode	$P_{TO}$	0,110	kW	Type of energy input	electrical		
Standby mode	$P_{SB}$	0,090	kW				
Crankcase heater mode	$P_{CK}$	0,064	kW				
Other items							
Capacity control	variable			For air-to-water heat pumps: Rated air flow rate, outdoors	-	5000	m <sup>3</sup> /h
Sound power level, indoors/ outdoors	$L_{WA}$	-49	dB	For water-/brine-to-water heat pumps: Rated brine or water flow rate, outdoor heat exchanger	-	--	m <sup>3</sup> /h
Emissions of nitrogen oxides	$NO_x$	-	mg/kWh				
For heat pump combination heater:							
<b>Declared load profile</b>	-			<b>Water heating energy efficiency</b>	$\eta_{wh}$	-	%
Daily electricity consumption	$Q_{elec}$	-	kWh	Daily fuel consumption	$Q_{fuel}$	-	kWh
Contact details	Glen Dimplex Deutschland GmbH, Am Goldenen Feld 18, 95326 Kulmbach						
(*) For heat pump space heaters and heat pump combination heaters, the rated output $P_{rated}$ is equal to the design load for heating $P_{designh}$ , and the rated heat output of a supplementary capacity for heating $sup(T_j)$ .							
(**) If $C_{dh}$ is not determined by measurement then the default degradation is $C_{dh} = 0,9$							
(-) not applicable							

# 15 Dimension drawings

## 15.1 Dimension drawing

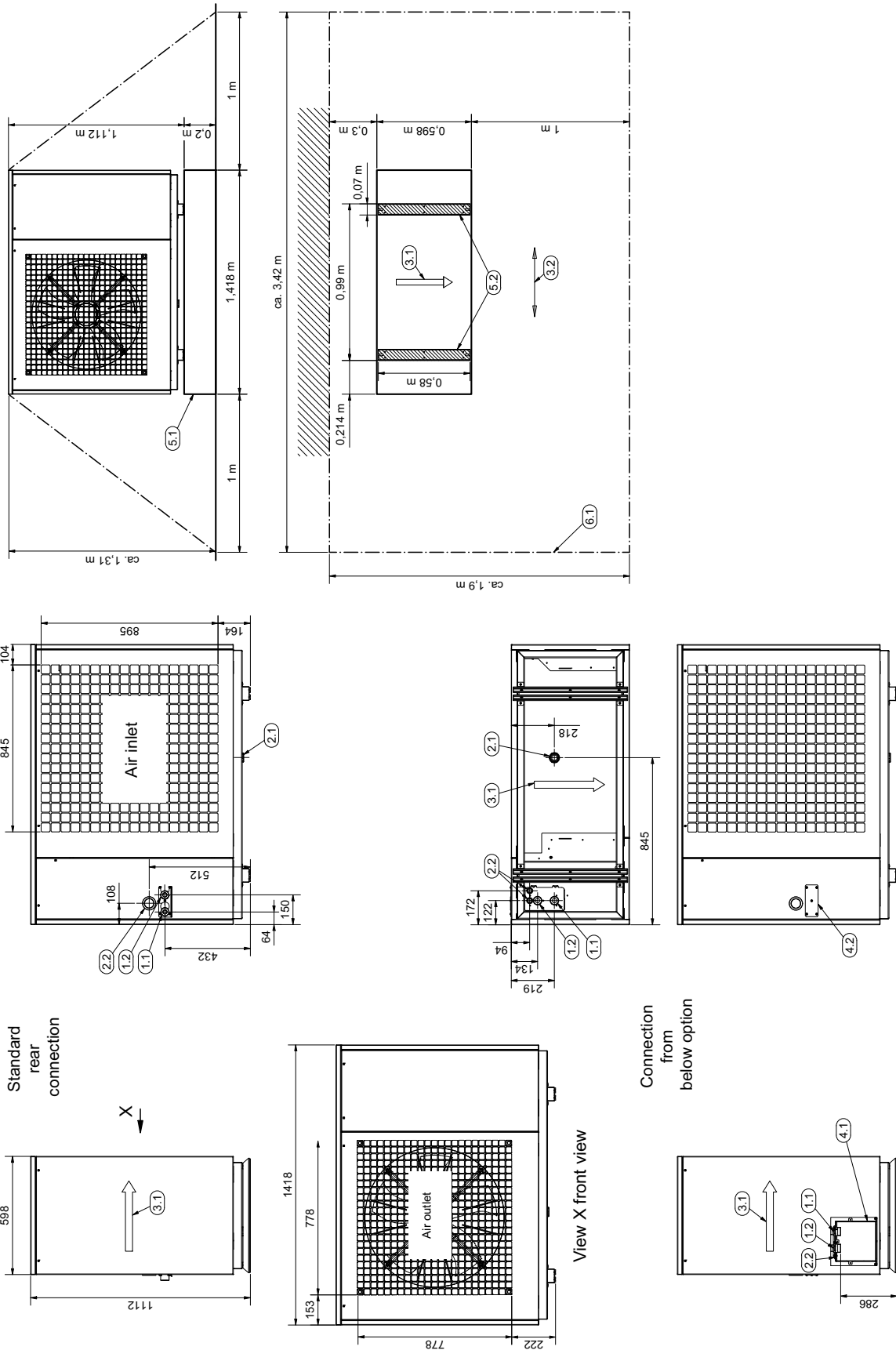

## 15.2 Dimension drawing legend

1.1	Flow G 1 1/4" external thread, flat-sealing
1.2	Return G 1 1/4" external thread, flat-sealing
2.1	Feed-through - condensate pipe
2.2	Feed-through - electric wire
3.1	Direction of air flow
3.2	Main wind direction with free-standing installation
4.1	Installation shaft for connection from below (optional accessory)
4.2	Cover on connection from below version (optional accessory)
5.1	Foundation
5.2	Floor bracket mounting surface
6.1	Safety and maintenance zone for R290 see Chap. 6 on page 8



# 16 Diagrams

## 16.1 Heating curve

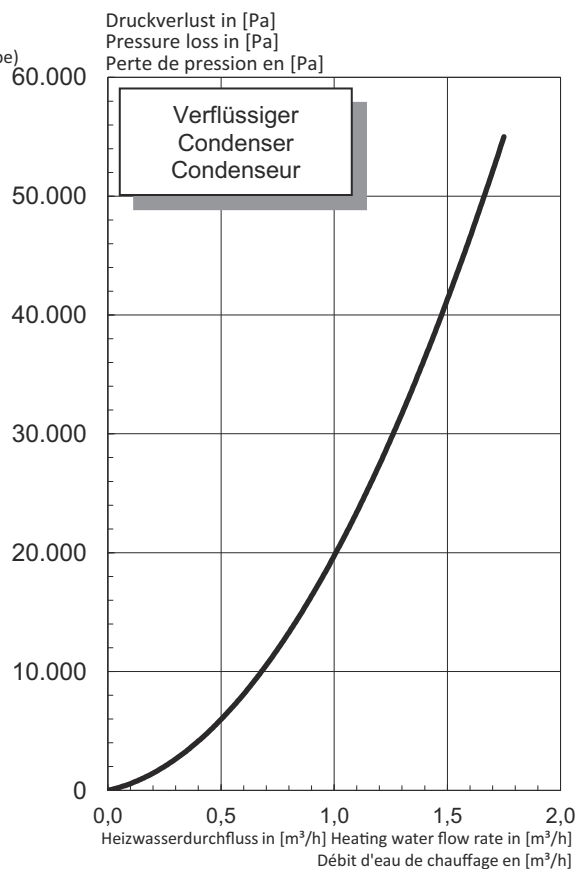
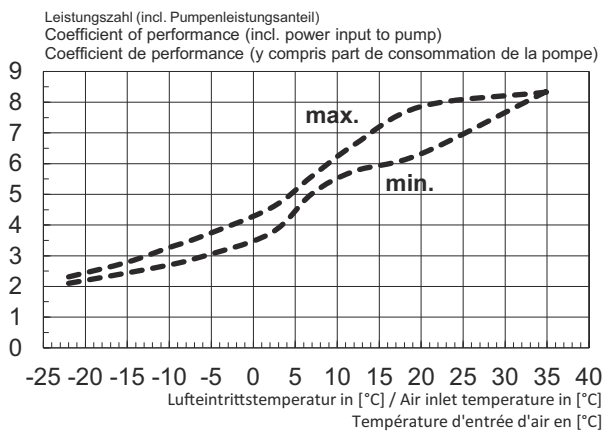
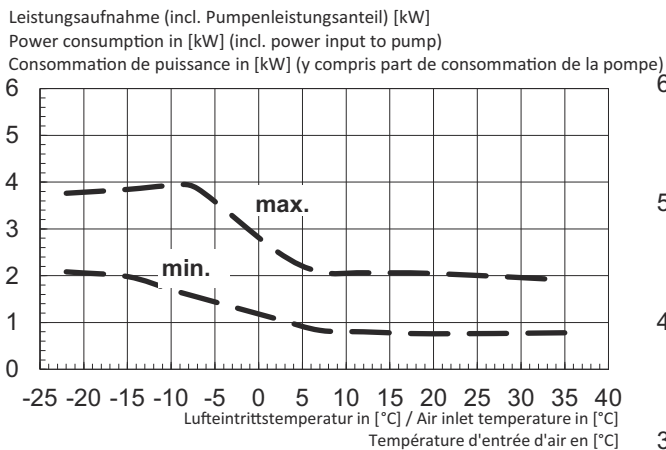
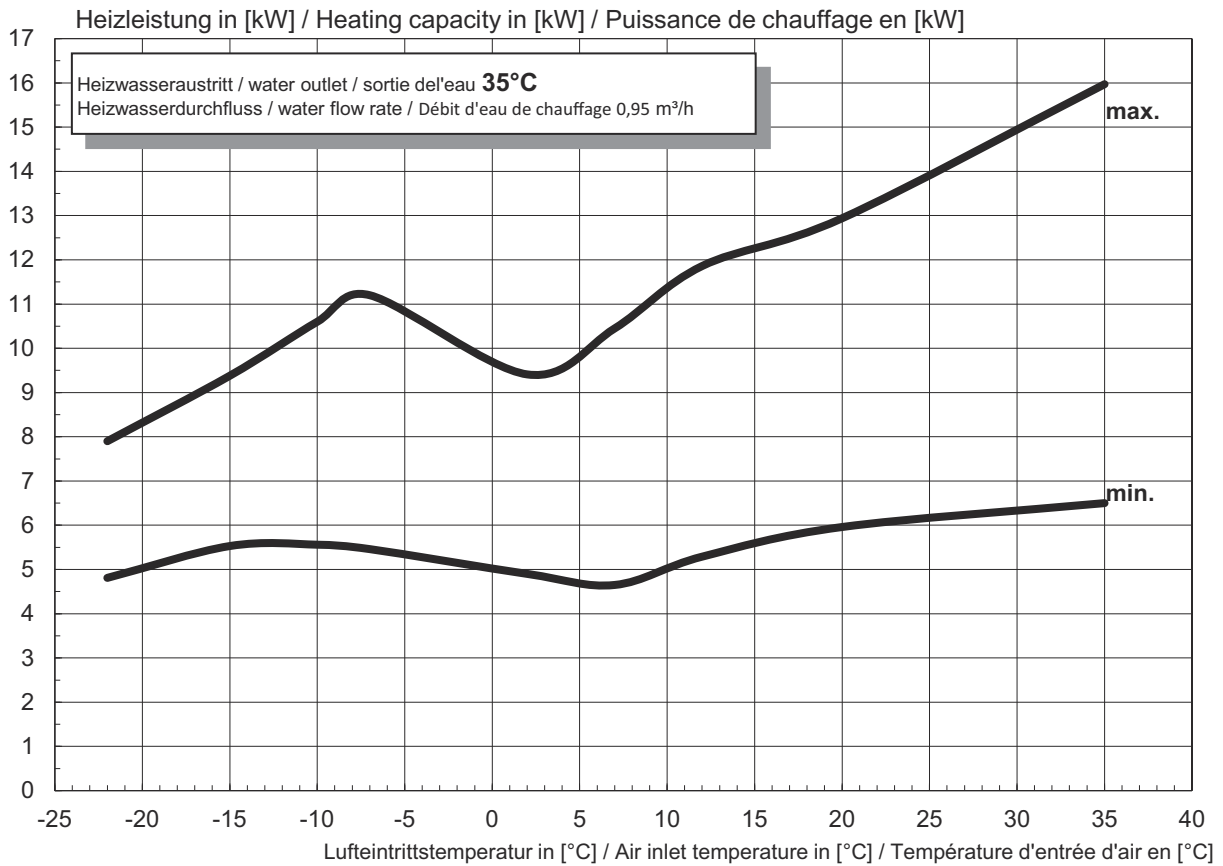

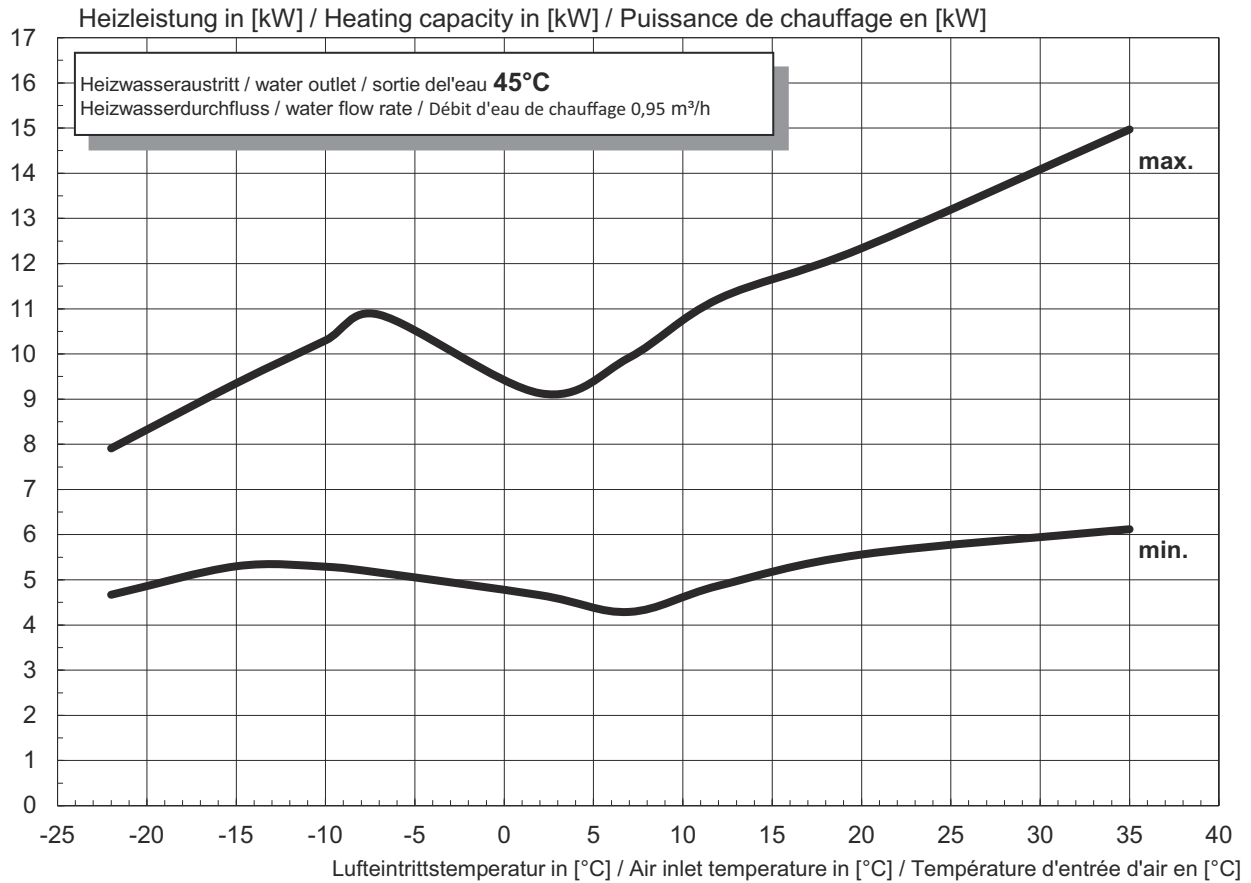

Leistungsaufnahme (incl. Pumpenleistungsanteil) [kW]  
 Power consumption in [kW] (incl. power input to pump)  
 Consommation de puissance in [kW] (y compris part de consommation de la pompe)

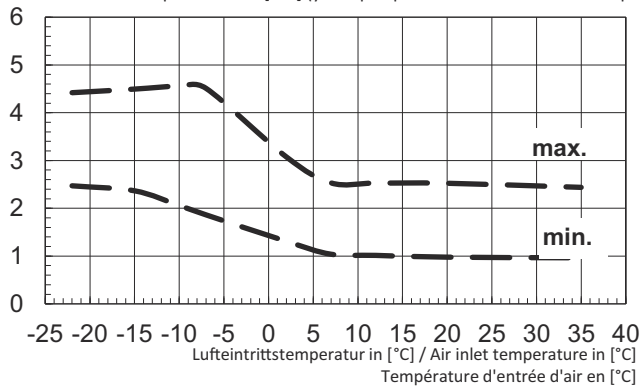

Leistungszahl (incl. Pumpenleistungsanteil)  
 Coefficient of performance (incl. power input to pump)  
 Coefficient de performance (y compris part de consommation de la pompe)

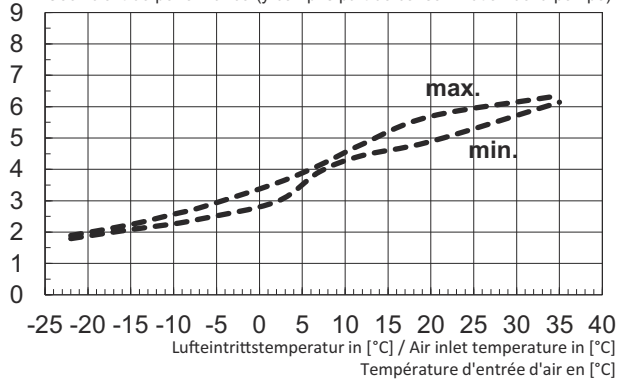

Druckverlust in [Pa]  
 Pressure loss in [Pa]  
 Perte de pression en [Pa]

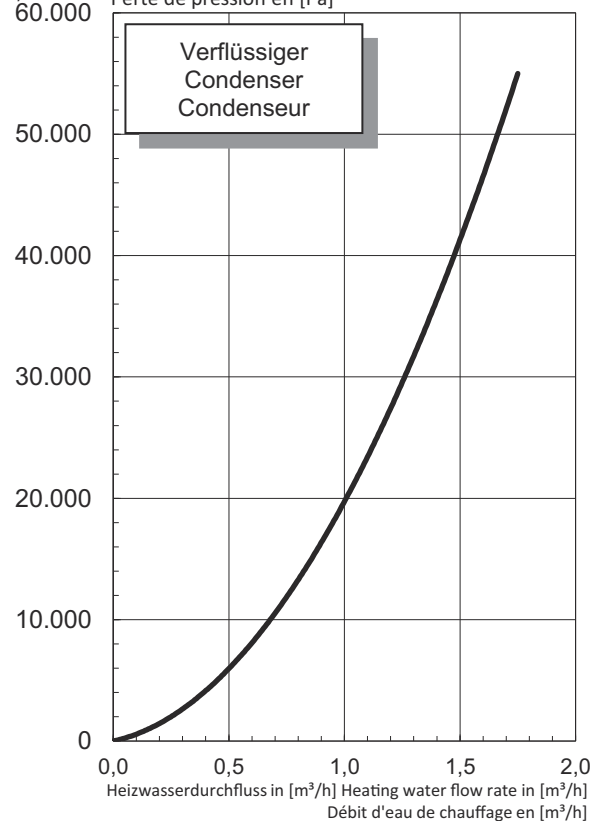

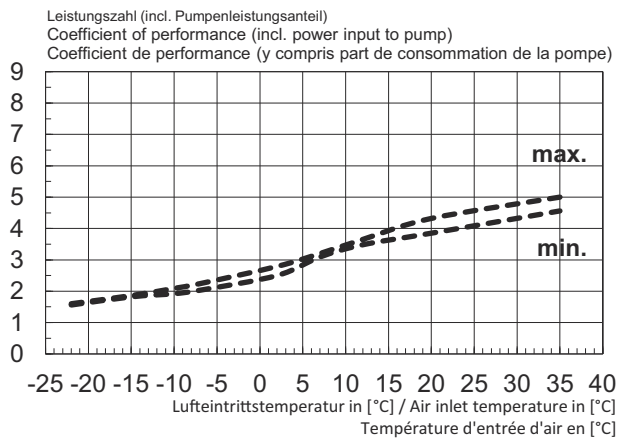
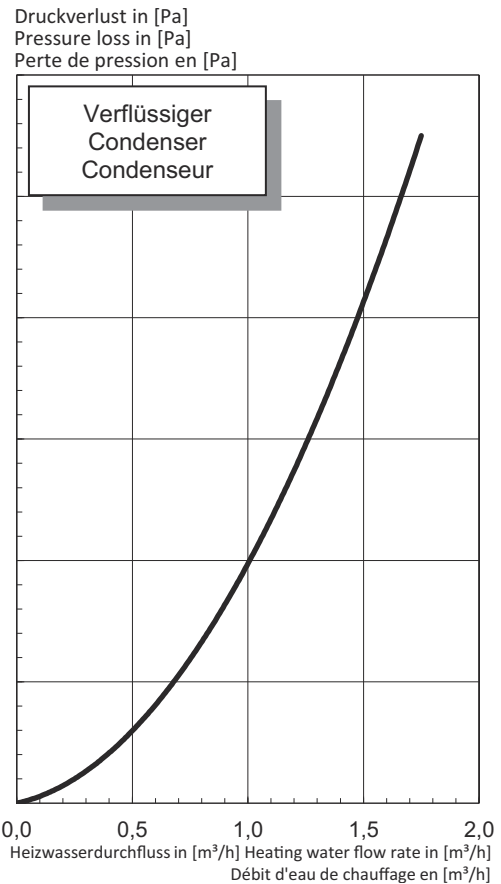
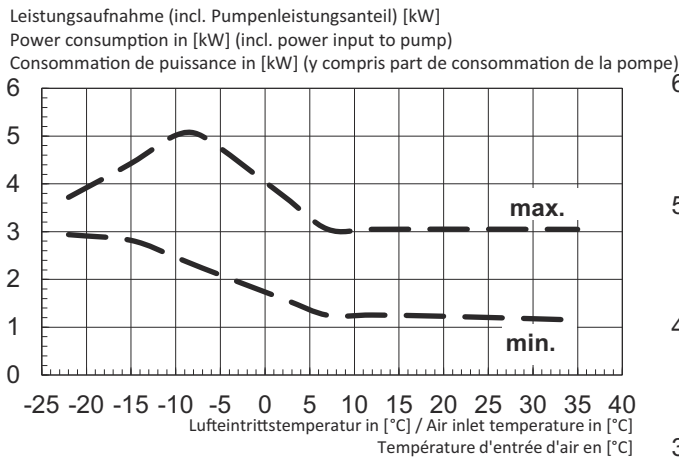
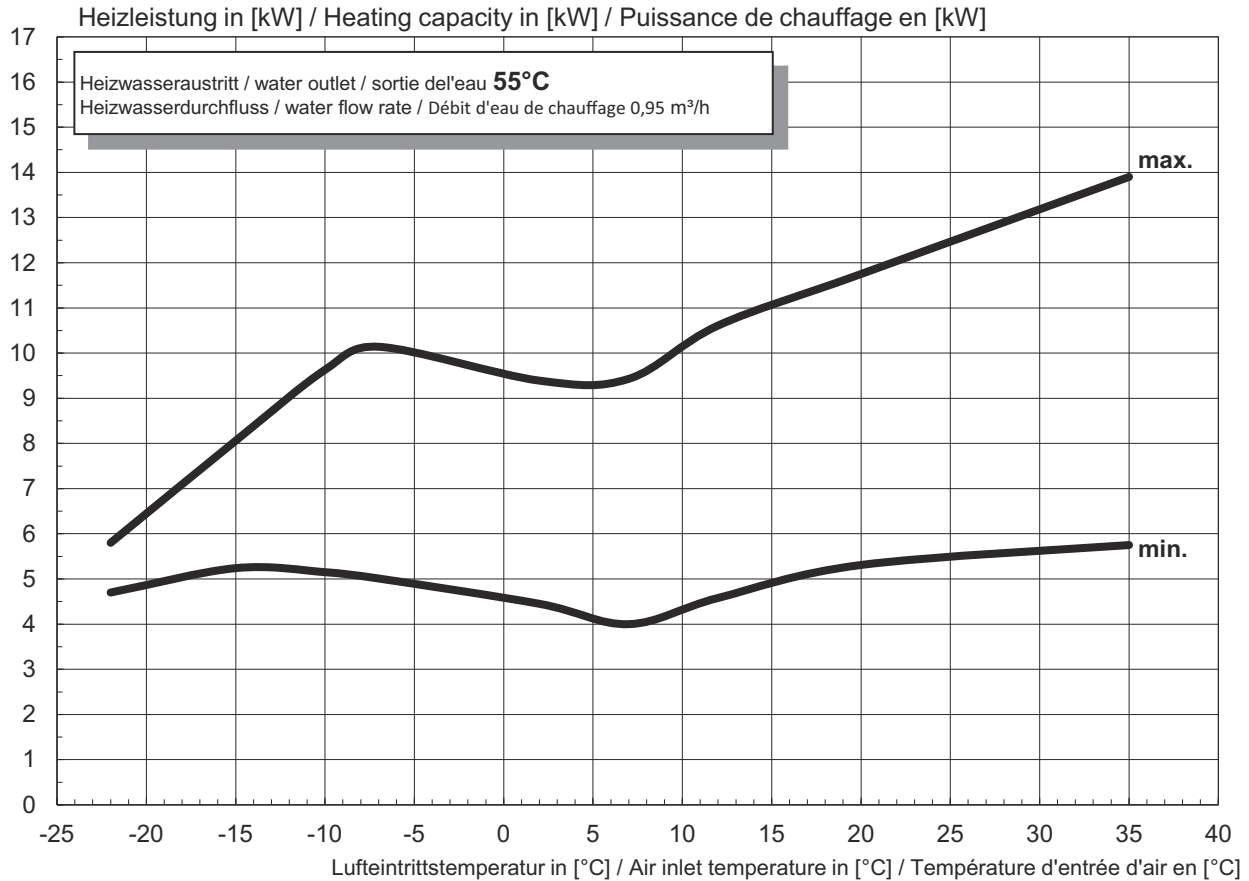

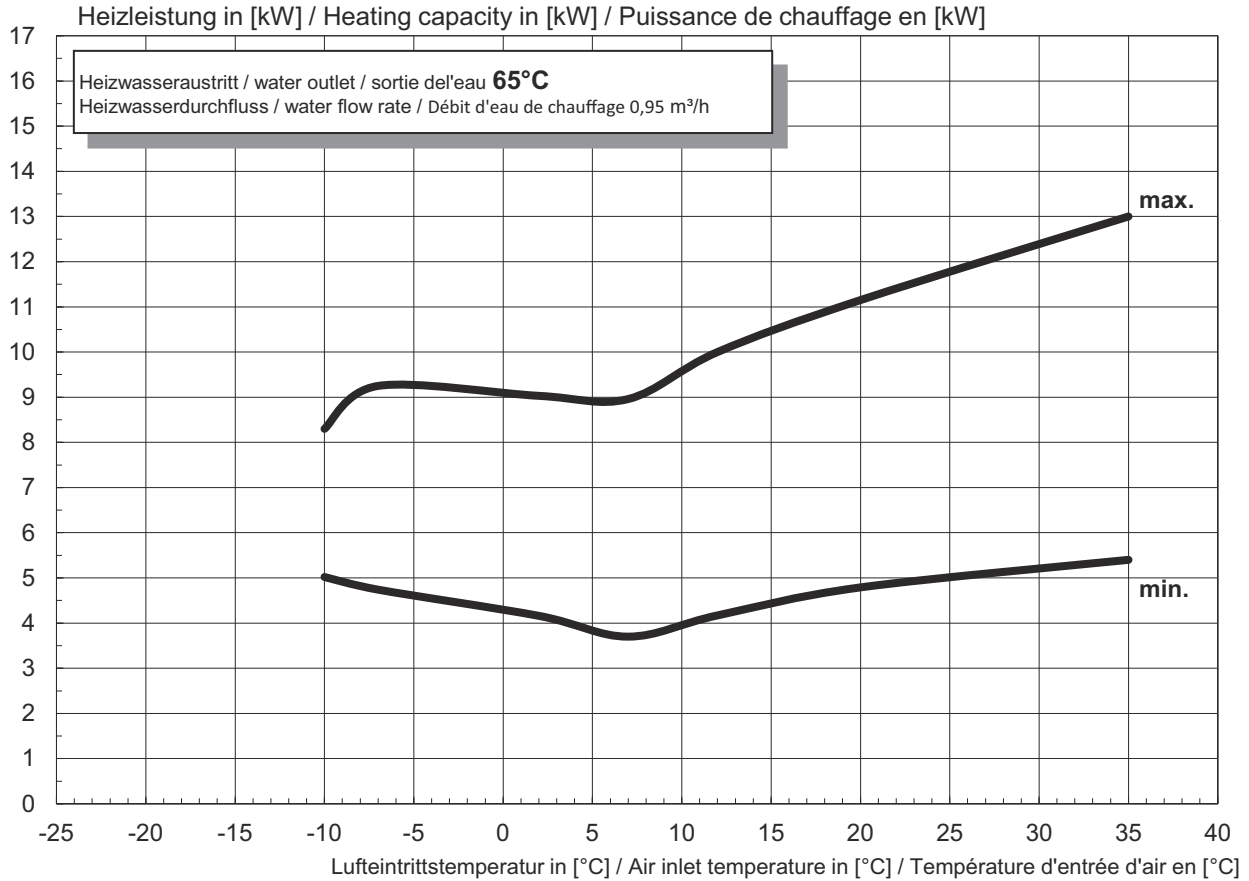

Leistungsaufnahme (incl. Pumpenleistungsanteil) [kW]  
 Power consumption in [kW] (incl. power input to pump)  
 Consommation de puissance in [kW] (y compris part de consommation de la pompe)

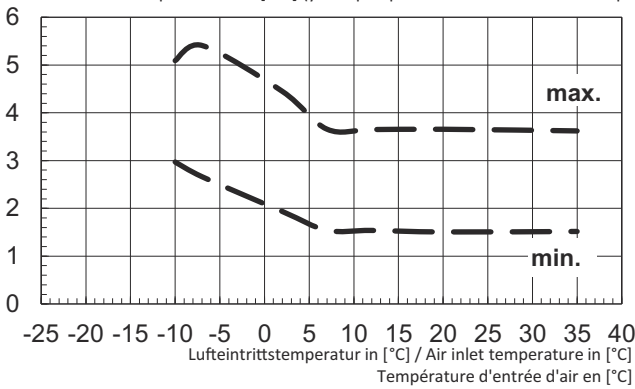

Druckverlust in [Pa]  
 Pressure loss in [Pa]  
 Perte de pression en [Pa]

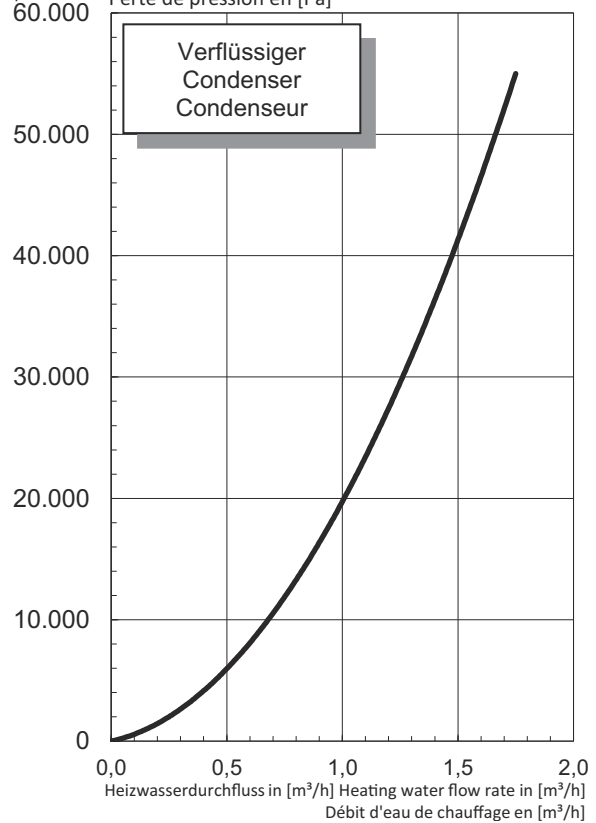

Leistungszahl (incl. Pumpenleistungsanteil)  
 Coefficient of performance (incl. power input to pump)  
 Coefficient de performance (y compris part de consommation de la pompe)

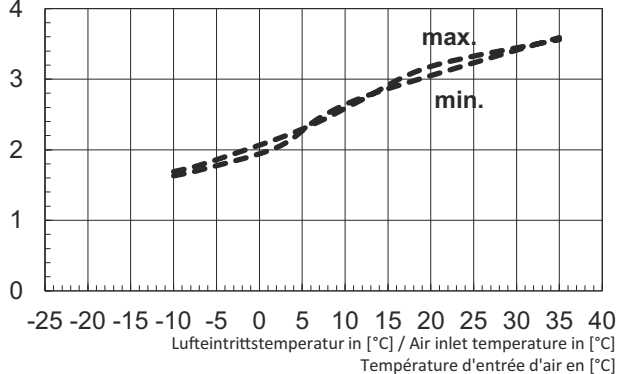

### 16.2 Cooling curve

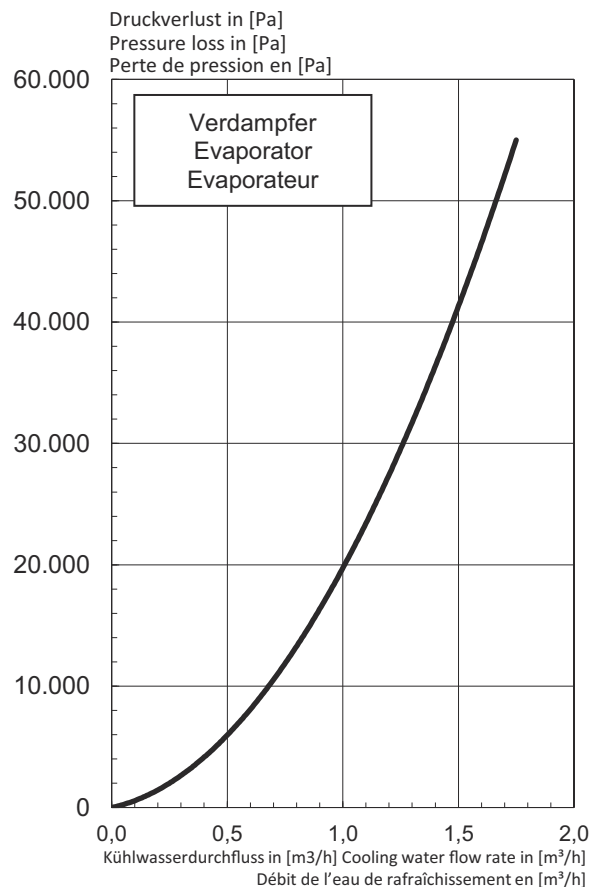
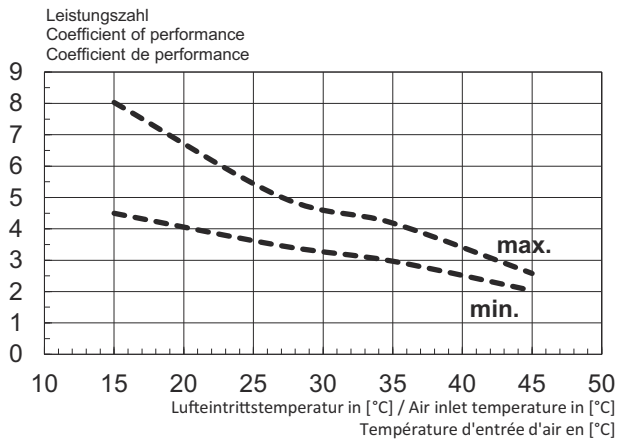
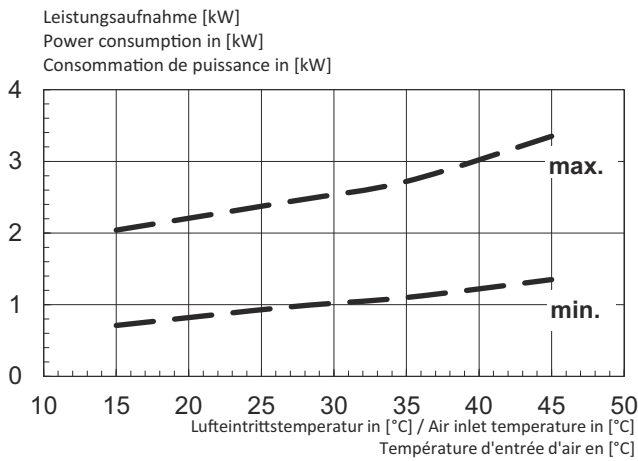
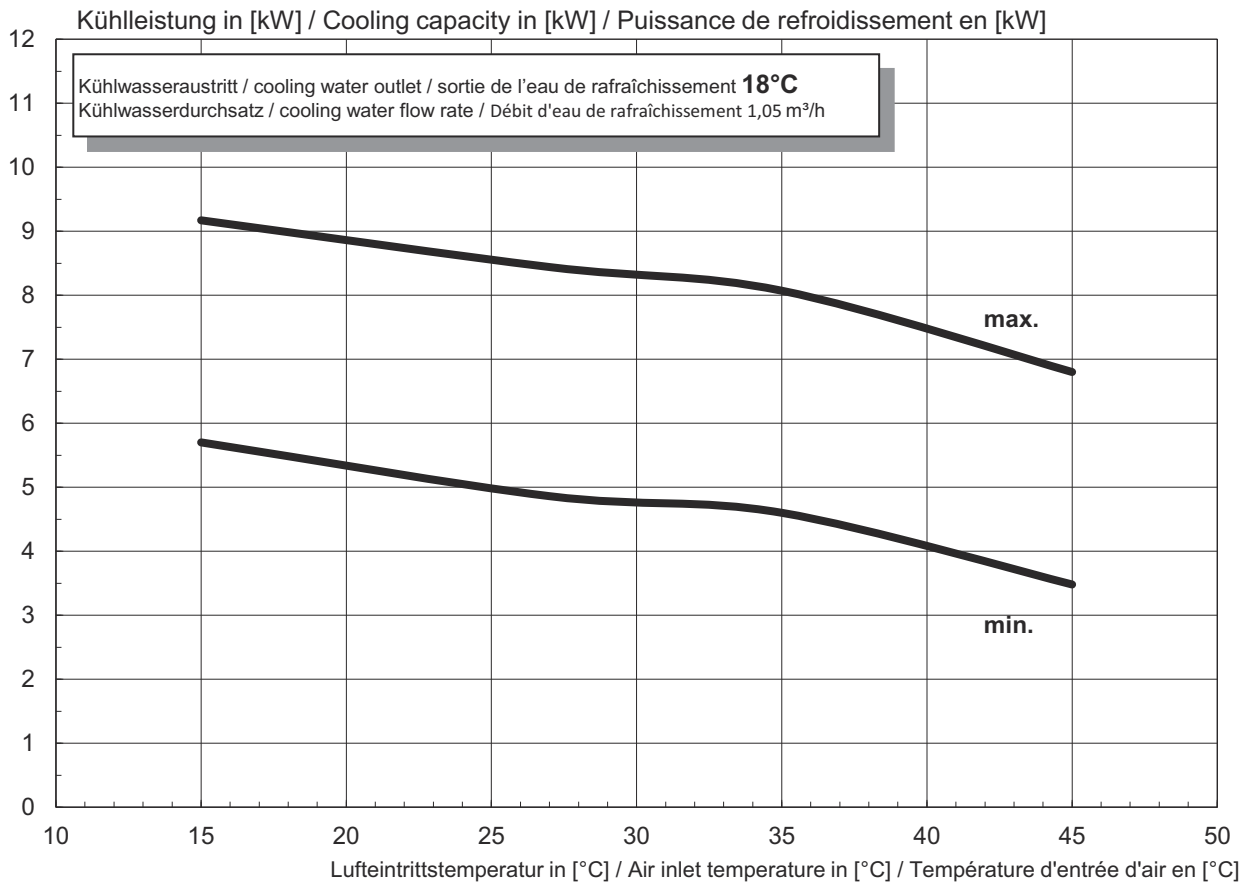

## 16.3 Heating operating limit

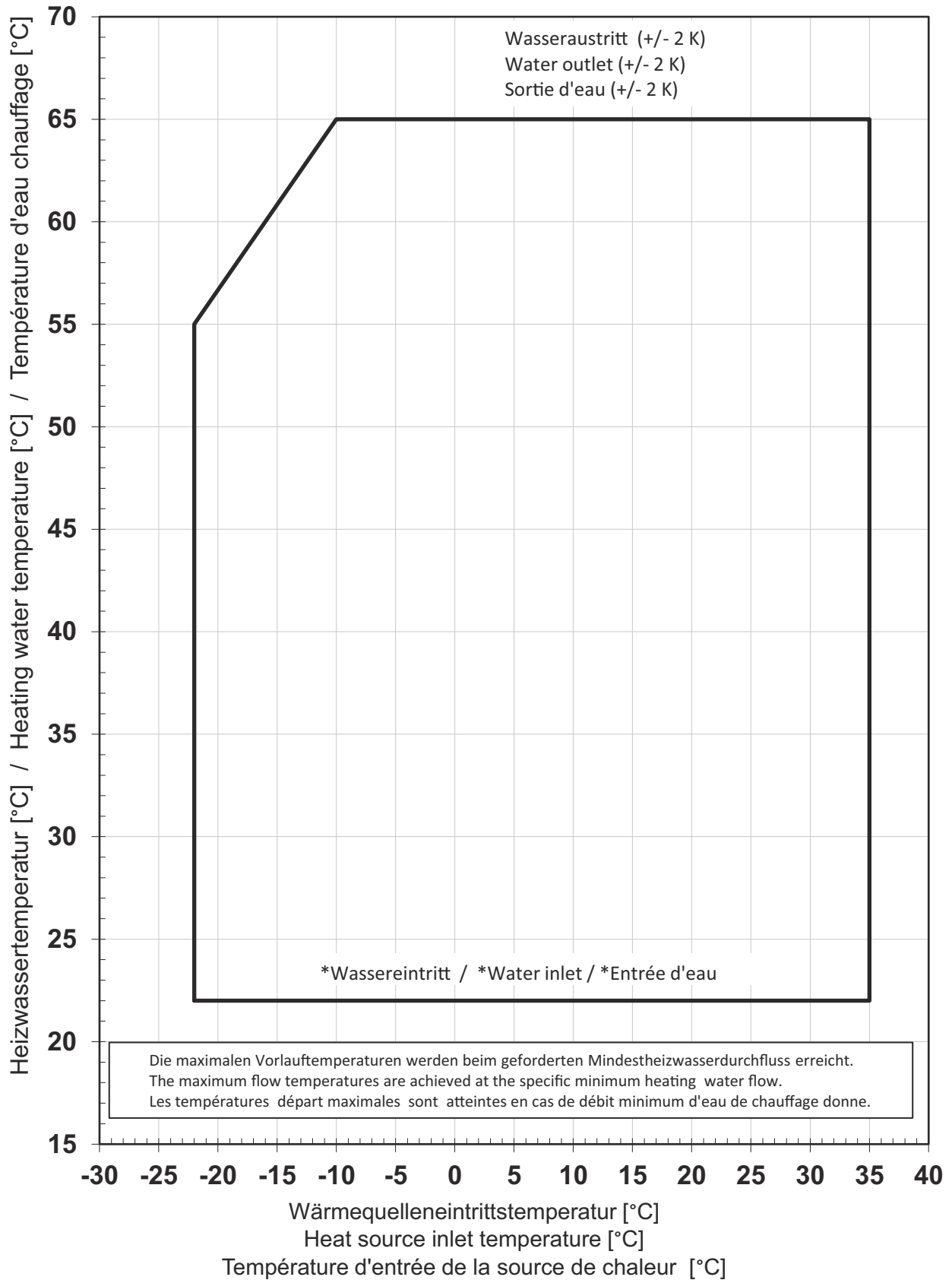

\*Bei Luft/Wasser-Wärmepumpen stellt die minimale Heizwassertemperatur die Mindest-Rücklauftemperatur dar  
\*For air-to-water heat pumps the minimum heating water temperature is the minimum return temperature  
\*Sur les pompes à chaleur air / eau, la température minimale d'eau de chauffage correspond à la température retour minimale

## 16.4 Cooling operating limit

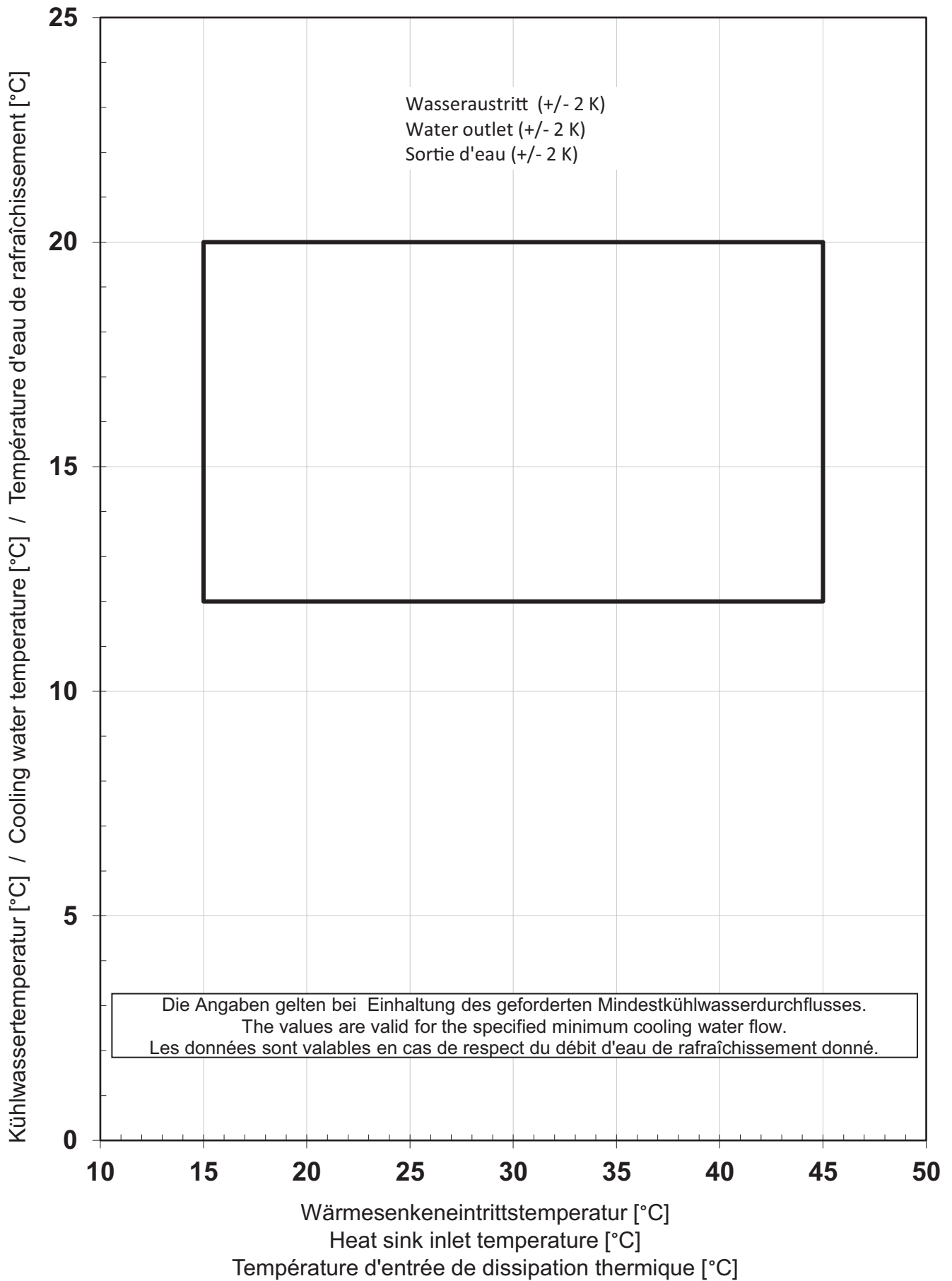

## 17 Integration Diagram

### 17.1 Hydraulic integration diagram

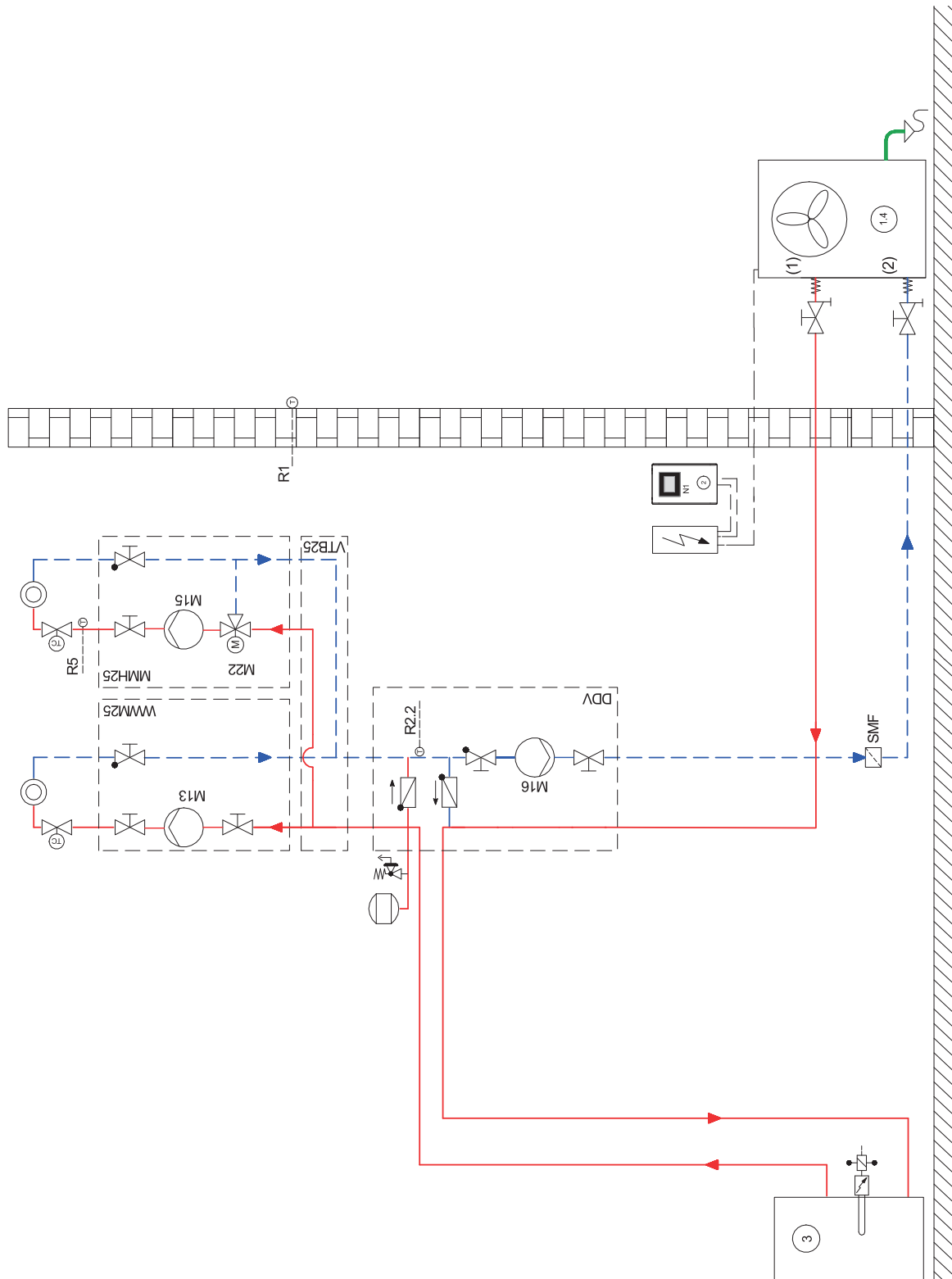

#### **i** NOTE

The hydraulic integration diagram is an example and intended only as an aid. The system requires professional and safety-approved layout by a specialist planner. All information in the section on installation and the corresponding safety notes must be observed at all times.





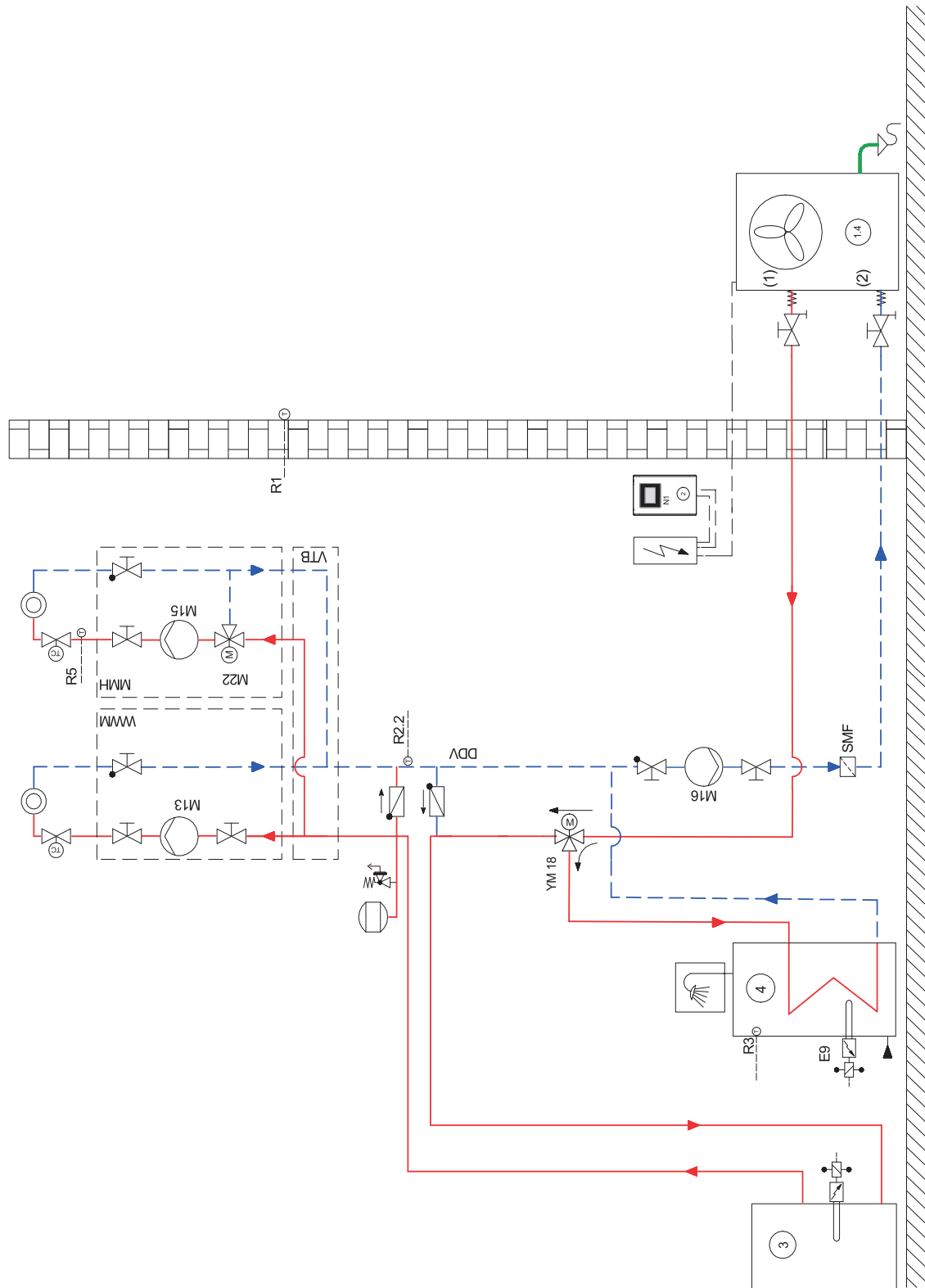















## 17.2 Hydraulic integration diagram



**i NOTE**

The hydraulic integration diagram is an example and intended only as an aid. The system requires professional and safety-approved layout by a specialist planner. All information in the section on installation and the corresponding safety notes must be observed at all times.

## 17.3 Legend

	Isolating valve
	Safety valve combination
	Circulating pump
	Expansion vessel
	Room-temperature controlled valve
	Isolating valve with check valve
	Isolating valve with drainage
	Heat consumer
	Four-way reversing valve
	Temperature sensor
	Flexible connection hose
	Check valve
	Three-way mixer
	Dirt trap
	Three-way mixer
	Air-to-water heat pump
	Heat pump manager
	Buffer tank connected in series
	Domestic hot water cylinder
E9	Flange heater domestic hot water
M13	Heat circulating pump main circuit
M15	Heat circulating pump for 2nd heating circuit
M16	Auxiliary circulating pump
M22	Mixer for 2nd heating circuit
N1	Heat pump manager
R1	External wall sensor
R2.2	Demand sensor
R3	Domestic hot water sensor
R5	Temperature sensor for 2nd heating circuit
SMF	Dirt trap
YM18	Domestic hot water reversing valve

## 18 Declaration of conformity

You can find the current CE declaration of conformity to download at:

**<https://dimplex.de/la1118cp>**



## **Glen Dimplex Deutschland**

### **Head office**

Glen Dimplex Deutschland GmbH  
Am Goldenen Feld 18  
D-95326 Kulmbach

T +49 9221 709-101  
F +49 9221 709-339  
info@dimplex.de  
www.dimplex.de

## **On site service**

After-sales service, technical support and spare parts. Assistance before and after installation of your equipment

T +49 9221 709-545  
F +49 9221 709-924545  
Mon - Thu: 7:00 to 17:00  
Fri: 7:00 to 15:00  
service@dimplex.de

Outside these opening times,  
in an emergency you can contact  
our 24/7 hotline.

Request after-sales service on the internet:  
[www.dimplex.de/dimplex-service](http://www.dimplex.de/dimplex-service)