

LA 1422C

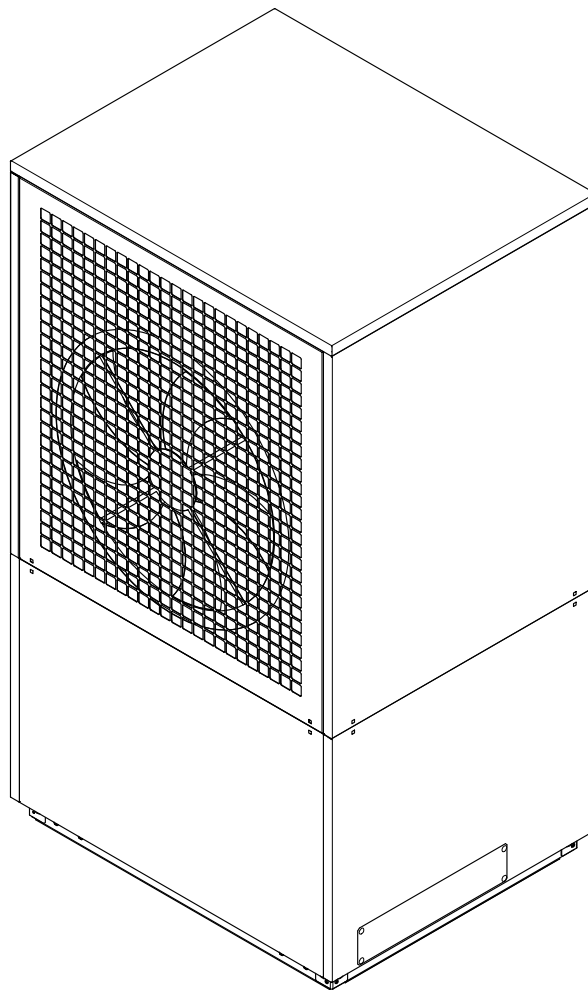

Installation and Operating Instruction

Air-to-Water
Heat Pump for
Outdoor Installation

Table of contents

1	Safety notes	EN-2
1.1	Symbols and markings.....	EN-2
1.2	General safety notes.....	EN-2
1.3	Intended use.....	EN-3
1.4	Legal regulations and directives.....	EN-3
1.5	Energy-efficient use of the heat pump.....	EN-3
2	Intended use of the heat pump	EN-4
2.1	Area of application.....	EN-4
2.2	Operating principle.....	EN-4
2.3	Functional description for integrated thermal energy metering.....	EN-4
3	Scope of supply	EN-5
3.1	Basic unit.....	EN-5
3.2	Switch box.....	EN-5
3.3	Heat pump manager.....	EN-5
4	Transport	EN-6
5	Installation	EN-7
5.1	General.....	EN-7
5.2	Condensate pipe.....	EN-7
6	Assembly	EN-8
6.1	General.....	EN-8
6.2	Connection on heating side.....	EN-8
6.3	Water quality in heating systems.....	EN-8
6.4	Electrical connection.....	EN-11
7	Commissioning	EN-12
7.1	General.....	EN-12
7.2	Preparation.....	EN-12
7.3	Procedure.....	EN-12
8	Cleaning/maintenance	EN-13
8.1	Care.....	EN-13
8.2	Cleaning the heating system.....	EN-13
8.3	Cleaning the air system.....	EN-13
9	Faults/troubleshooting	EN-14
10	Decommissioning/disposal	EN-14
11	Device Information	EN-15
12	Product information as per Regulation (EU) No 813/2013, Annex II, Table 2	EN-17
13	Dimension Drawings	EN-18
13.1	Dimension Drawing.....	EN-18
14	Diagrams	EN-19
14.1	Characteristic curves for heating operation.....	EN-19
14.2	Characteristic curves for cooling operation.....	EN-20
14.3	Operating limits diagram heating.....	EN-21
14.4	Operating limits diagram cooling.....	EN-22
15	Integration diagram	EN-23
15.1	Hydraulic integration diagrams.....	EN-23
15.2	Hydraulic integration diagrams.....	EN-24
15.3	Legend.....	EN-25
16	Declaration of Conformity	EN-26

1 Safety notes

1.1 Symbols and markings

Particularly important information in these instructions is marked with CAUTION! or NOTE.

⚠ CAUTION!

Immediate danger to life or danger of severe personal injury or significant damage to property.

i NOTE

Risk of damage to property or minor personal injury or important information with no further risk of personal injury or damage to property.

1.2 General safety notes

The following warnings and safety notes must be observed in all life phases of the unit:

⚠ CAUTION!

Work on the heat pump must only be performed by authorised and qualified after-sales service technicians!

⚠ CAUTION!

Failure to use personal protective equipment could result in severe injury. Risk of injury!

- ▶ Use of personal protective equipment (PPE) in accordance with DGUV regulation 100-500, Chap. 2.35.
- ▶ Personal protective equipment consisting of safety gloves, safety shoes, safety glasses and long clothing that fully covers the body.

⚠ CAUTION!

There is a risk of falling or slipping on trip hazards and leaking operating materials. Risk of injury!

- ▶ Trip hazards caused by cables, pipes and hoses must be avoided.
- ▶ Operating material leaks must be absorbed with suitable binding agents and disposed of in accordance with the hazard class.

⚠ CAUTION!

Work may only be carried out on the unit outdoors in dry weather conditions. Risk of damage to the unit or electric shock!

- ▶ In wet weather conditions, such as rain, snow, etc., the housing of the heat pump must be kept properly closed

⚠ CAUTION!

Do not stand near the unit during storms. Risk of lightning!

- ▶ Do not stand in the immediate vicinity of the heat pump.

⚠ CAUTION!

Weather-related conditions on transport routes. Risk of injury due to slipping!

- ▶ Transport routes must be kept clear and weather-related conditions such as ice and snow must not impair safe transport.

⚠ CAUTION!

Before opening the unit, ensure that all electric circuits are disconnected from the power supply.

⚠ CAUTION!

Failure to observe the safety rules could result in electric shock. Danger to life!

- ▶ National and regional regulations on accident prevention and carrying out electrical installations must be observed.
- ▶ The following five safety rules should be used during electrical installation:
 - Disconnect from mains,
 - Secure against reconnection,
 - Confirm absence of voltage at all poles,
 - Ground and short-circuit,
 - Cover or guard off neighbouring areas that are live. After disconnecting the power supply, you have to wait 5 minutes before all components are de-energised.

⚠ CAUTION!

It is forbidden to operate the heat pump without safety devices (cover, grating).

⚠ CAUTION!

Please refrain from tampering with or altering the unit.

1.3 Intended use

This unit is only intended for use as specified by the manufacturer. Any other use beyond that intended by the manufacturer is prohibited. This requires the user to abide by the relevant project planning documents. Please refrain from tampering with or altering the unit.

1.4 Legal regulations and directives

This heat pump is designed for use in a domestic environment according to Article 1, Paragraph 2 k) of EU directive 2006/42/EC (Machinery Directive) and is thus subject to the requirements of EU directive 2014/35/EU (Low Voltage Directive). It is thus also intended for use by non-professionals for heating shops, offices and other similar working environments, agricultural establishments and hotels, guest houses and other residential buildings.

The construction and design of the heat pump complies with all relevant EU directives, and DIN/VDE regulations (see CE declaration of conformity).

When connecting the heat pump to the power supply, the relevant VDE, EN and IEC standards are to be adhered to. Any further connection requirements stipulated by local utility companies must also be observed.

When connecting the heating system, all applicable regulations must also be adhered to.

This unit can be used by children aged 8 and over and by persons with limited physical, sensory or mental aptitude or lack of experience and/or knowledge, providing they are supervised or have been instructed in safe use of the unit and understand the associated potential dangers.

Children must not play with the unit. Cleaning and user maintenance must not be carried out by children without supervision.

i NOTE

When operating or maintaining a heat pump, the legal requirements of the country where the heat pump is operated apply. Depending on the refrigerant fill quantity, the heat pump must be inspected for leaks at regular intervals by a certified technician, and these inspections must be recorded.

More information can be found in the accompanying log book.

1.5 Energy-efficient use of the heat pump

With the purchase of this heat pump, you are helping to protect the environment. A prerequisite for energy-efficient operation is the correct design of the heat source system and heating system.

To maintain heat pump efficiency, it is particularly important to keep the temperature difference between the heating water and heat source to a minimum. For this reason, it is advisable to design the heat source and heating system very carefully. **A temperature difference of approx. 1 Kelvin (1 °C) higher increases power consumption by around 2.5 %.** When designing the heating system, it should be borne in mind that special consumers such as domestic hot water preparation should also be taken into consideration and dimensioned for low temperatures. **Underfloor heating systems (panel heating)** are optimally suited for heat pump use on account of the low flow temperatures (30 °C to 40 °C).

It is important to ensure that the heat exchangers are not contaminated during operation, as this increases the temperature difference, which in turn reduces the coefficient of performance (COP).

When set correctly, the heat pump manager is also an essential factor in the energy-efficient use of the heat pump. Further information can be found in the heat pump manager operating instructions.

2 Intended use of the heat pump

2.1 Area of application

The air-to-water heat pump is to be used exclusively for the heating and cooling of heating water. It can be used in new or existing heating systems.

The circulating pump(s) must be controlled using the heat pump manager.

If function-relevant or safety-relevant pump functions, such as integration of the heat pump into the building management system, are not supported, then this can result in loss of warranty and cause a write-off of the heat pump.

The circulating pump(s) and the heat pump controller must always be ready for operation.

The specifications in the technical documents must be followed, particularly limit values for the minimum and – if available – maximum warm/cold water volume flow.

The heat pump is suitable for mono energy and bivalent operation in outside air temperatures to -22 °C.

Proper defrosting of the evaporator is guaranteed by maintaining a heating water return temperature of more than 22 °C (+2 °C/-0 °C) during continuous operation.

The heat pump is not designed for the increased heat consumption required when a building is being dried out. For this reason, the additional heat consumption should be met using special units provided by the customer. If a building is to be dried out in autumn or winter, we recommend installing an additional electric heating element (available as an accessory).

In cooling operation, the heat pump is suitable for air temperatures ranging from +15 °C to +45 °C. It can be used for silent and dynamic cooling. The minimum cooling water inlet temperature is +7 °C.

i NOTE

The unit is not suitable for operation with a frequency converter.

2.2 Operating principle

Heating

Outside air is drawn in by the fan and fed via the evaporator (heat exchanger). The evaporator cools the air, i.e. extracts heat from it. This extracted heat is then transferred to the working medium (refrigerant) in the evaporator.

The heat is "pumped" to a higher temperature level by increasing its pressure with the aid of an electrically driven compressor. It is then transferred to the heating water via the liquefier (heat exchanger).

Electrical energy is used to raise the temperature level of the heat from the environment. Since the energy extracted from the air is transferred to the heating water, this type of unit is referred to as an air-to-water heat pump.

Main components of the air-to-water heat pump are the evaporator, fan, expansion valve, 4-way reversing valve, as well as the compressor, the liquefier and the electrical control system.

At low ambient temperatures, humidity accumulates on the evaporator in the form of frost, reducing the transfer of heat. Uneven accumulation during this process does not indicate a fault. The evaporator is defrosted automatically by the heat pump as required. Under certain atmospheric conditions, steam may be emitted from the air outlet.

Cooling

The functions of the evaporator and the liquefier are reversed in the "Cooling" operating mode.

The heating water transfers its heat to the refrigerant via the liquefier, which is now functioning as an evaporator. The refrigerant is brought to a higher temperature level using the compressor. Heat is transferred to the surrounding air via the liquefier (which, in heating operation, functions as an evaporator).

2.3 Functional description for integrated thermal energy metering

The compressor manufacturer's performance specifications for different pressure levels are stored in the heat pump software. Two additional pressure sensors for determining the current pressure level are installed in the refrigeration circuit of the heat pump, one before and one after the compressor. The current heat output can be calculated from the compressor data stored in the software and the current pressure level. The integral for the heat output over the runtime gives the quantity of thermal energy supplied by the heat pump, which is displayed separately for heating, domestic hot water preparation and swimming pool water preparation on the heat pump manager display.

The integrated thermal energy metering must not be used for heating cost billing purposes. EN 1434 is not applicable.

3 Scope of supply

3.1 Basic unit

The heat pump contains the components listed below.

The refrigeration circuit is "hermetically sealed" and contains the fluorinated refrigerant R410A incorporated in the Kyoto protocol. Information on the GWP value and CO₂ equivalent of the refrigerant is available under "Device Information". The refrigerant is CFC-free, non-ozone depleting and non-combustible.

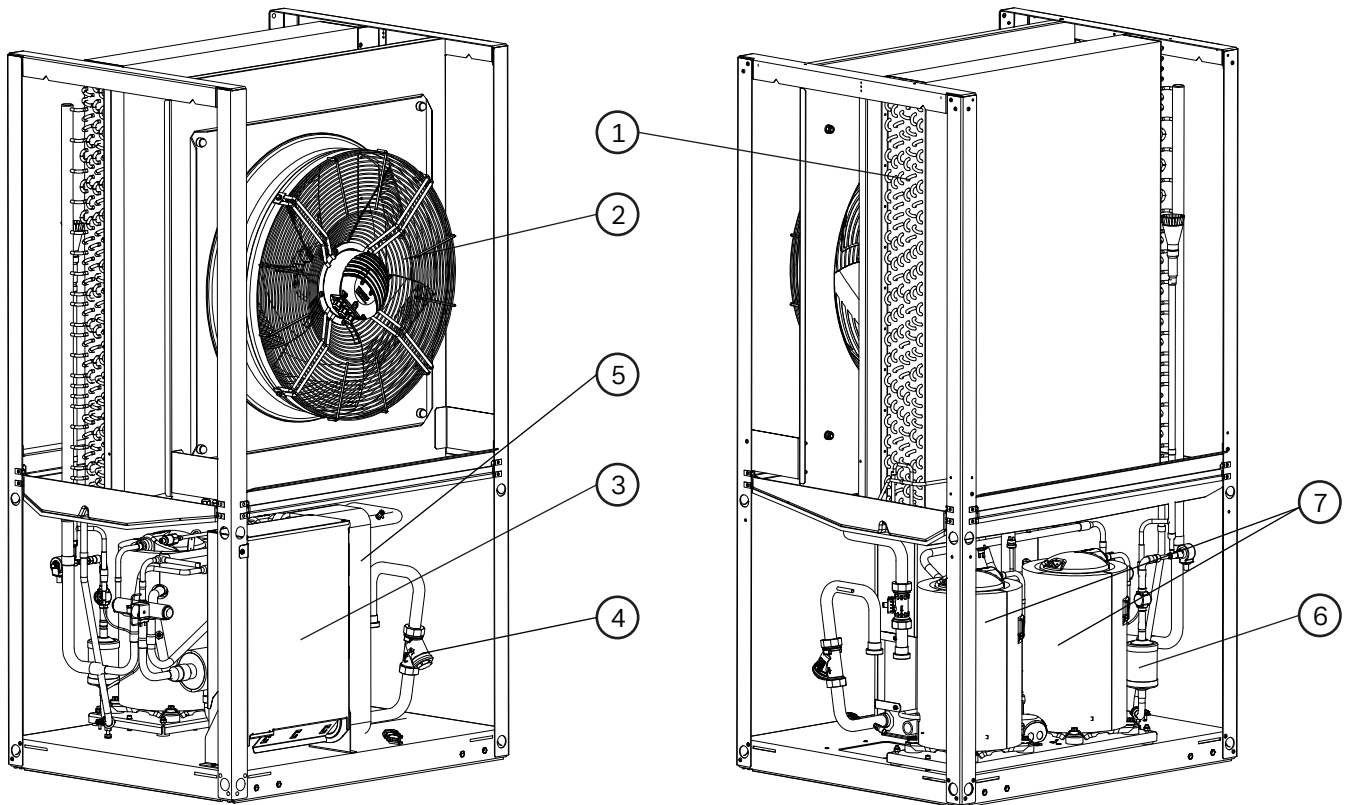

- 1) Evaporator
- 2) Fan
- 3) Switch box
- 4) Dirt trap
- 5) Liquefier
- 6) Filter dryer
- 7) Compressor

3.2 Switch box

The switch box located in the unit can be folded out once the bottom front cover has been removed and the fixing screw has been loosened.

The power supply terminals, power contactors, the soft starter units and the extended controller unit (refrigeration circuit control) are inside the switch box. The refrigeration circuit control monitors and controls all heat pump signals and communicates with the heat pump manager.

Communication and control or mains cables, which should be routed apart from each other, are fed into the switch box through the cable entry area on the baseplate.

Routing through the side wall of the unit is possible by means of an accessory available separately.

3.3 Heat pump manager

The heat pump manager included in the scope of supply must be used to operate the air-to-water heat pump.

The heat pump manager is a convenient electronic regulation and control unit. It controls and monitors the entire heating system based on the outside temperature, as well as domestic hot water preparation and safety systems.

Sensors for heating, demand and outside temperature to be installed on site, including mounting material, are included with the heat pump manager.

The functions and usage of the heat pump manager are described in the operating instructions supplied with it.

4 Transport

⚠ CAUTION!

Risk of injury when lifting and setting down the load. Risk of crushing!

- ▶ Do not stand under the load when lifting and setting down.

⚠ CAUTION!

Risk of injury if unsuitable lifting devices are used incorrectly. Risk of falling and crushing!

- ▶ People may only stand outside the danger area.
- ▶ Observe the load capacity of the lifting devices and slings used. (Germany: DGUV regulation 109-017)

⚠ CAUTION!

Risk of the heat pump tipping over if unsuitable attachment points are used. Risk of falling and crushing!

- ▶ The heat pump may only be lifted from the operator side with a lift truck or forklift.

⚠ CAUTION!

Refrigerant may leak if the heat pump falls or is subject to impact load during transport.

- ▶ The unit must be checked immediately for leakages if it falls or is subject to impact load during transport.
- ▶ If outflow noises can be heard, if oily surfaces form or if a leakage is detected with a detector, the refrigerant must be drained off by a trained individual.
- ▶ If the leakage occurs inside a building, the affected area must be ventilated immediately.
- ▶ The heat pump must be returned to the manufacturer for repair if it is not possible to remedy the leakage onsite.

⚠ CAUTION!

The heat pump must not be tipped during transport. The machine must be secured to prevent the risk of tipping.

A pallet should be used for transportation to the final installation location. The basic unit can be transported with a lift truck, hand truck or by means of 3/4" pipes fed through the holes in the baseplate or frame (max. pipe diameter in the evaporator-compressor frame area, 25 mm). In the frame area, the pipes must run parallel to the operator side (see figure).

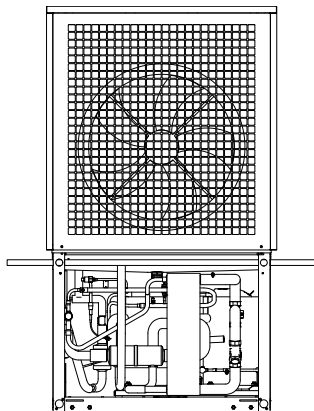

Before using the transport holes in the frame, it is necessary to remove the two bottom side panel assemblies. Each covering panel is secured with two screws. Once the screws have been loosened, the covering panels can be tilted (top plates by approx. 20°, bottom plates by approx. 45°). The bottom facade

plates can then be pulled out of the skirt panel, the top facade plates, which do not have to be removed for transport, can be hung out of the cover plate. Rehang the top panels by gently pushing them in an upwards direction.

i NOTE

Be careful not to damage any components when inserting the pipes through the frame.

The dust caps that were removed for usage of the transport bores in the base must be re-inserted in order to prevent small animals from entering into the interior of the unit and to ensure sufficient sound insulation.

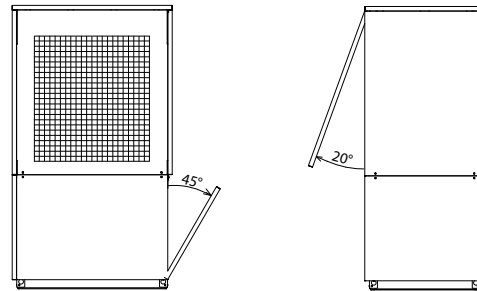

Once the heat pump has been set up in its intended location, the transport fastenings (2x M6 screws) must be removed from the compressor plate (the front or rear covering panel at the bottom must be removed for this).

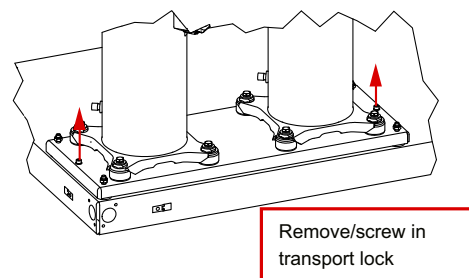

⚠ CAUTION!

Before commissioning, the transport fastening must be removed.

5 Installation

5.1 General

The unit must be installed on a permanently even, smooth and horizontal surface. The entire frame should be in direct contact with the ground in order to ensure an adequate soundproof seal, to prevent the water-bearing components from becoming too cold and to protect the inside of the unit from small animals. If this is not the case, additional insulation measures may be necessary. To prevent small animals from entering the inside of the unit, the connection hole in the base plate must be sealed, for example. Furthermore, the heat pump should be set up so that the air outlet direction of the fan is perpendicular to the main wind direction to allow unrestricted defrosting of the evaporator. The heat pump is fundamentally designed for installation on even ground. For different conditions (e.g.: fitting on a platform or flat roof) or where there is a greater risk of the heat pump tipping over (e.g. due to an exposed position or high wind exposure), additional protection against tipping over must be provided. The responsibility for the heat pump installation lies with the specialist system construction company. During the installation, local requirements such as building regulations, the static load of the building, and wind exposure must be accounted for.

It must be possible to carry out maintenance work without hindrance. This is ensured when observing the distances to solid walls as shown in the figure.

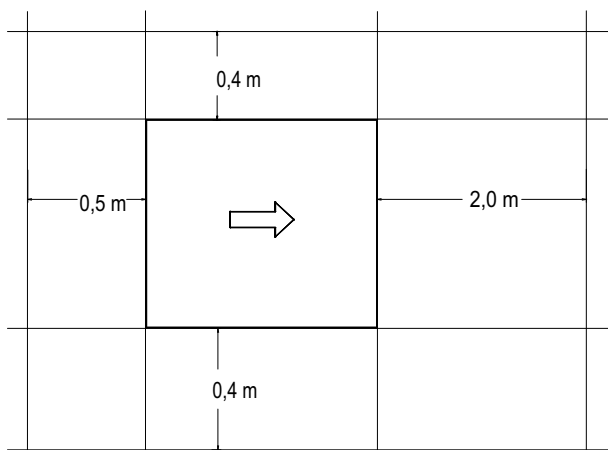

i NOTE

The heat pump is not intended for use above 2000 metres (mean sea level).

⚠ CAUTION!

Do not restrict or block the area around the intake or the air outlet area.

⚠ CAUTION!

Observe country-specific building regulations.

⚠ CAUTION!

Structural influences must be observed for installation close to walls. No windows or doors should be present in the area surrounding the air outlet of the fan.

⚠ CAUTION!

In cases of installation close to walls, there may be more sediment in the intake and air outlet area due to the air flow. The colder outside air outlet should discharge in such a way as to not increase the heat losses in heated neighbouring rooms.

⚠ CAUTION!

Installation in a hollow or in an inner courtyard is not permitted because cooled air collects at ground level and is drawn in again by the heat pump during prolonged operation.

5.2 Condensate pipe

Condensate that forms during operation must be drained off frost free. To ensure proper drainage, the heat pump must be mounted horizontally. The condensate pipe must have a minimum diameter of 50 mm and must be fed into a sewer in such a way that it is safe from frost. Do not discharge the condensate directly into clarifiers or cesspits. The aggressive vapours and a condensate pipe laid in an area which is not frost-free can destroy the evaporator.

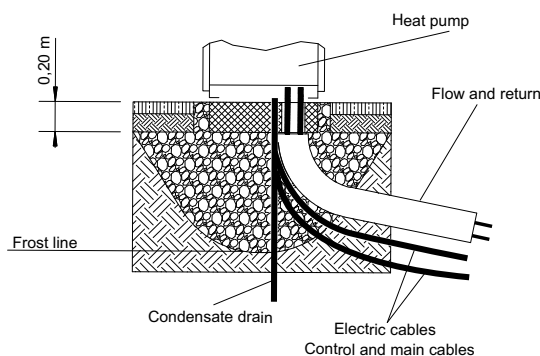

6 Assembly

6.1 General

The following connections need to be established on the heat pump:

- Flow and return of the heating system
- Communication line (heat pump manager)
- Control voltage line (heat pump manager)
- Supply voltage line (electrical distribution system)
- Condensate drain

6.2 Connection on heating side

The heating system connections on the heat pump have a 1 1/4" external thread. A spanner must be used to firmly grip the transitions when connecting the heat pump.

⚠ CAUTION!

Fault on the safety switching equipment of the hydraulic circuit intended for pressure limitation. Risk of injury!

- ▶ **The safety switching equipment of the hydraulic circuit intended for pressure limitation must be checked for proper installation and functionality before commissioning.**

Before connecting the heating water system to the heat pump, the heating system must be flushed to remove any impurities, residue from sealants, etc. Any accumulation of deposits in the liquefier may cause the heat pump to completely break down. For systems in which the heating water flow rate can be shut off via the radiator or thermostat valves, an overflow valve must be installed by the customer in a heating bypass downstream from the heat pump. This ensures a minimum heating water flow rate through the heat pump and helps to avoid faults.

Once the heat pump has been connected to the heating system, it must be filled, purged and pressure-tested.

i NOTE

Pump units with check valves maintain the specified flow direction. If there is incorrect distribution or breaking off of the volume flow, these units (and the check valves in particular) must be checked! The use of check valves is mandatory in the event of several heating circuits or parallel connections for heat pumps in order to avoid incorrect distribution.

6.3 Water quality in heating systems

6.3.1 Scale formation

Scale formation in heating systems cannot be avoided, but in systems with flow temperatures below 60 °C the problem is so small that it is negligible. With high-temperature heat pumps and in particular with bivalent systems in the higher performance range (heat pump + boiler combination), flow temperatures of 60 °C and more can be achieved. One preferred method for preventing scale formation is softening because this permanently removes alkaline earths (calcium and magnesium ions) from the heating system.

The following values for water quality in heating water and cold water must be observed and checked during an on-site check:

- Degree of hardness
- Conductivity
- pH value
- Filterable materials

The following (limit) values must absolutely be observed:

- Maximum degree of hardness in filling water and supplementary water 11 dGH.
- The conductivity in demineralised water (DM water) (low-salt) may not be greater than 100 µS/cm.
- The conductivity in partially demineralised water (saline) may not be greater than 500 µS/cm.
- The pH value must be between 8.2 and 9.
- The limit value for filterable materials in heating water is < 30 mg/l.

If necessary, for example in bivalent systems, the specifications listed in the table below must also be observed, or the precise guidelines for filling water and supplementary water and the total hardness must be taken from the table in accordance with VDI 2035 – Sheet 1.

i NOTE

The specific volumes of a heating system must be determined before filling the system.

The saturation index SI is used to determine whether water has a tendency towards lime dissolution or lime separation. This shows whether the pH value corresponds to a neutral pH point or by how much it undershoots it due to excess acid or by how much it exceeds it due to carbonic acid deficit. At a saturation index below 0, the water is aggressive and will tend towards corrosion. At a saturation index above 0, the water is calcareous.

The saturation index SI should be between - 0.2 < 0 < 0.2

Filling and supplementary water as well as heating water, depending on heat output			
Overall heat output in kW	Total alkaline earths in mol/m ³ (total hardness in dGH)		
	≤ 20	> 20 to ≤ 50	> 50
Specific system volume in l/kW Heat output ¹			
≤ 50 Specific water content heat generator > 0.3 k per kW ²	none	≤ 3.0 (16.8)	< 0.05 (0.3)
≤ 50 Specific water content heat generator > 0.3 k per kW ² (e.g. circulation water heaters) and systems with electrical heating elements	≤ 3.0 (16.8)	≤ 1.5 (8.4)	
> 50 kW to ≤ 200 kW	≤ 2.0 (11.2)	≤ 1.0 (5.6)	
> 200 kW to ≤ 600 kW	≤ 1.5 (8.4)	< 0.05 (0.3)	
> 600 kW	< 0.05 (0.3)	< 0.05 (0.3)	
Heating water, depending on heating output			
Operating mode	Electrical conductivity in µS/cm		
Low-salt ³	> 10 to ≤ 100		
Containing salt	> 100 to ≤ 1500		
	Appearance		
	clear, free from sedimentary substances		

1. For the purpose of calculating the specific system volume, the smallest individual heat output is to be used for systems with several heat generators.
2. In systems with several heat generators with different specific water contents, the smallest specific water content is decisive.
3. Full softening is recommended for systems with aluminium alloys.

Fig. 6.1: Guideline values for filling and supplementary in accordance with VDI 2035

⚠ CAUTION!

When using demineralised water, ensure that the minimum permissible pH value of 8.2 is not undershot. Failure to comply with this value can result in the heat pump being destroyed.

6.3.2 Corrosion

The VDI 2035 recommends the use of partially demineralised water or demineralised water in systems with larger-than-average specific system volumes of 50 l/kW.

These measures (e.g. pH stabilizers) are implemented to set the pH value of the heating water to minimise the risk of corrosion in the heat pump and in the heating system.

Irrespective of the legal requirements, the following limit values in the heating water used for various substances must not be undershot or exceeded. This is to ensure safe operation of the heat pump. A water analysis must be carried out before commissioning the system. If the water analysis produces a "-" for a maximum of one indicator or a "o" for a maximum of two indicators, the analysis must be classed as negative.

Evaluation characteristic	Concentration area (mg/l or ppm)	Stainless steel	Copper
Bicarbonate (HCO ₃ ⁻)	< 70	+	o
	70 - 300	+	+
	> 300	+	o
Sulphate (SO ₄ ²⁻)	< 70	+	+
	70 - 300	o	o/-
	> 300	-	-
Hydrogencarbonate/sulphate HCO ₃ ⁻ /SO ₄ ²⁻	> 1.0	+	+
	< 1.0	o	-
Electrical conductivity ¹	< 10 µS/cm	o	o
	10 - 500 µS/cm	+	+
	> 500 µS/cm	o	o
pH value ²	< 6.0	-	-
	6.0 - 8.2	o	o
	8.2 - 9.0	+	+
	> 9.0	o	o
Ammonium (NH ₄ ⁺)	< 2	+	+
	2 - 20	o	o
	> 20	-	-
Chloride ions (Cl ⁻)	< 50	+	+
	50 - 150	o	o
	> 150	-	-
Free chlorine (Cl ₂)	< 0.5	+	+
	0.5 - 5	-	o
	> 5	-	-
Hydrogen sulphide (H ₂ S)	< 0.05	+	+
	> 0.05	+	o/-
Carbon dioxide (CO ₂)	< 5	+	+
	5 - 10	+	o
	> 10	o	-
Nitrate (NO ₃ ⁻)	< 100	+	+
	> 100	o	o
Iron (Fe)	< 0.2	+	+
	> 0.2	o	o
Aluminium (Al)	< 0.2	+	+
	> 0.2	+	o
Manganese (Mn)	< 0.05	+	+
	> 0.05	o	o

Saturation Index	< -0.2	o	o
	-0.2 - 0.1	+	+
	0.1 - 0.2	+	o
	> 0.2	o	o
Filterable materials	< 30	+	+
	> 30	-	-
Total hardness	< 6 °dGH	o/+	o/+
	6 - 11 °dGH	+	+
	> 11 °dGH	-	-
Oxygen (O ₂)	< 0.02	+	+
	< 0.1	+/o	+/o
	> 0.1	-	-
Nitrite (NO ₂ ⁻)	< 0.1	+	+
	> 0.1	-	-
Sulphide (S ²⁻)	< 1.0	+	+
	> 1.0	-	-

1. If the limit values in the VDI 2035 are more restrictive, these apply accordingly.
2. When using demineralised water, ensure that the minimum permissible pH value of 8.2 is not undershot. Failure to comply with this value can result in the heat pump being destroyed.

Fig. 6.2: Limit values for the quality of heating water

Resistance of copper-soldered or welded stainless-steel plate heat exchangers to the substances present in water:

Notes

- "+" = Normally good resistance
- "o" = Corrosion problems may arise, particularly if several factors receive an evaluation of "o"
- "-" = Should not be used

i NOTE

The water quality should be checked again after 4 to 6 weeks, as the quality could change during the first few weeks of operation due to chemical reactions.

i NOTE

It is mandatory to use hydraulically closed systems. The use of open hydraulic systems is not permitted.

i NOTE

The notes/settings in the instructions of the heat pump manager must always be observed and carried out accordingly; not doing so will lead to malfunctions.

Minimum heating water flow rate

The minimum heating water flow rate through the heat pump must be assured in all operating statuses of the heating system. This can be accomplished, for example, by installing either a dual differential pressureless manifold or an overflow valve. The procedure for setting an overflow valve is described in the chapter "Commissioning". When the minimum heating water flow rate is undershot, the plate heat exchanger in the refrigeration circuit can freeze, which can lead to total loss of the heat pump.

The nominal flow rate is specified depending on the max. flow temperature in the device information and must be taken into account during planning. With design temperatures below 30 °C in the flow, the design must be based on max. volume flow with 5 K spread for A7/W35.

The specified nominal flow rate (see "Device Information" on page 15.) must be assured in all operating states. A built-in flow rate sensor is used only for switching off the heat pump in the event of an unusual and abrupt drop in the heating water flow rate and not for monitoring and fusing the nominal flow rate.

i NOTE

The use of an overflow valve is only recommended for panel heating and a maximum heating water flow rate of 1.3 m³/h. System faults may result if this is not observed.

Frost protection

A method of manual drainage (see Fig. 6.3) should be provided for heat pumps which are exposed to frost. The frost protection function of the heat pump manager is active whenever the heat pump manager and the heat circulating pump are ready for operation. In the event of decommissioning or power failure, the system must be drained and, if necessary, blown out at the points shown (see Fig. 6.3). The heating circuit should be operated with a suitable frost protection if heat pump systems are implemented in buildings where a power failure cannot be detected (holiday home).

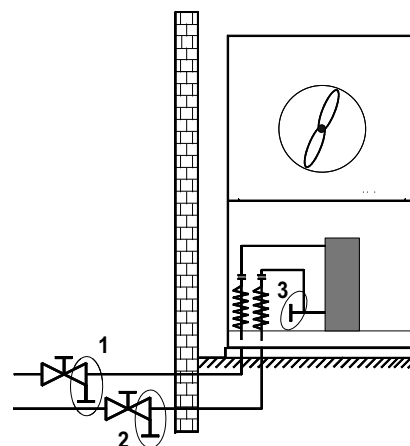

Fig. 6.3: Position of draining device

6.4 Electrical connection

6.4.1 General

All electrical installation work must be carried out by a trained electrician or a specialist for the specified tasks in accordance with the

- installation and operating instructions
- country-specific installation regulations (e.g. VDE 0100),
- technical connection conditions of the energy supplier
- and supply grid operator (e.g. TAB) and
- local conditions.

To ensure that the frost protection function of the heat pump works properly, the heat pump manager must remain connected to the power supply and the flow must be maintained through the heat pump at all times.

The switching contacts of the output relay are interference-suppressed. Therefore, depending on the internal resistance of the measuring instrument, a voltage can also be measured when the contacts are open. However, this will be much lower than the line voltage.

Controller terminals -N0/J2..J15; -N1/J1..15, J25 and J26 or the LV adapter boards are connected to extra-low voltage. If, due to a wiring error, the line voltage is mistakenly connected to these points, the controller will be destroyed.

6.4.2 Electrical installation work

3 lines/cables must be routed to the heat pump in total:

- The heat pump is connected to the power using a commercially available 5-wire cable.
The cable must be provided on-site. The line cross section is selected in accordance with the power consumption of the heat pump (see attachment Device Information) and the applicable VDE (EN) and VNB regulations. An all-pole disconnecting device with a contact gap of at least 3 mm (e.g. utility blocking contactor or power contactor) must be installed in the heat pump power supply. A 3-pole circuit breaker with common tripping of all phase conductors (tripping current according to Device Information) provides short-circuit protection, taking into consideration the design of the internal wiring.
The relevant components in the heat pump receive internal overload protection.
The clockwise rotating field of the load supply must be ensured when connecting,
Phase sequence: L1, L2, L3.

⚠ CAUTION!

Ensure that there is a clockwise rotating field: With incorrect wiring, starting of the heat pump is prevented. A corresponding warning is indicated on the display of the heat pump manager (adjust wiring).

- The control voltage is supplied via the heat pump manager. To this end, a 3-pole line should be routed following the electric's documentation. Further information on the wiring of the heat pump manager is available in the heat pump manager operating instructions.

- A shielded communication line (not included in the scope of supply) connects the heat pump manager with the refrigeration circuit controller installed in the heat pump. More detailed instructions can be found in the heat pump manager operating instructions and in the electrical documentation.

i NOTE

The communication cable is necessary for the function of air-to-water heat pumps. It must be shielded and laid separately from the mains cable.

6.4.3 Demand sensor connection

The demand sensor R2.2 (NTC 10) is included with the heat pump manager. It must be installed depending on the hydraulics used (see attachment, Chap. 3 for S. V).

If no demand sensors are connected, then, in the event of an interruption in communication with the heat pump manager, it is possible that there will not be any control of the 2nd heat generator either.

i NOTE

The return sensor R2 installed in the heat pump is active when the compressor is running and must not be disconnected.

i NOTE

Sensor cables can be extended up to 50 m with 2 x 0.75 mm cables.

6.4.4 High-performance circulating pump connection

In many cases, the supply voltage of the pump is stuck on continuous current when using larger electronically controlled circulating pumps (the manufacturer's information on the pump being used should be taken into consideration). The pump is then generally actuated using the Start/Stop input. This input is operated with extra low voltage from the pump (a link cable is usually inserted in the factory default of the pump). In order to be able to actuate the input, a coupling relay with a floating contact is required. This must be controlled with the pump function of a 230 V relay output of the controller. Due to the extra low voltage to be switched, a suitable relay with the appropriate contact material (gilded) must be selected and integrated on-site.

6.4.5 Frost protection

Regardless of the settings for the heat circulating pumps, they always run in heating, defrost and frost protection mode. In systems with multiple heating circuits, the 2nd and 3rd heat circulating pump has the same function.

⚠ CAUTION!

To ensure that the frost protection function on the heat pump works properly, the heat pump manager must remain connected to the power supply and the flow must be maintained through the heat pump at all times.

i NOTE

The primary pump (M11 – responsible for the heat source flow rate) and the secondary pump (M16 – responsible for the warm/cold water flow rate) must always be clamped to the heat pump manager in all cases. This is the only way to ensure the pump flows and returns necessary for operation and to ensure that the necessary safety measures are in place

7 Commissioning

7.1 General

To ensure that commissioning is performed correctly, it should only be carried out by an after-sales service technician authorised by the manufacturer. This may be a condition for an additional warranty (see "Warranty service").

7.2 Preparation

The following items must be checked prior to commissioning:

- All of the heat pump connections must be installed as described in Chapter 6.
- All valves which could impair the proper flow of the heating water in the heating circuit must be open.
- The air intake and air outlet paths must be clear.
- The fan must turn in the direction indicated by the arrow.
- The settings of the heat pump manager must be adapted to the heating system in accordance with the operating instructions.
- Ensure that the condensate drain functions properly.
- The accessories pack in the switch box and the accessories pack in the area below the fan must have been removed!
- The hydraulic network must be flushed correctly before installing the heat pump. This includes the supply line to the heat pump. Only when flushing is complete can the heat pump be hydraulically integrated.
- The dirt traps present as standard or included for assembly must be inspected between 4 and 8 weeks after the heat pump is commissioned or changes made to the heating system and cleaned if necessary. Further maintenance intervals must be scheduled depending on the level of soiling, which must be defined and carried out by a suitably qualified person.

Special notes for the integration of heat pumps in existing systems (renovations):

The existing heat distribution network (pipe materials, connection types, etc.) and the existing heating systems (e.g. radiators, underfloor heating, etc.) can impact the quality of the water in existing systems. Particularly when welded steel pipes or pipes that are not oxygen diffusion-proof are used, deposits, scaling, silting or similar may be present that can cause damage in the heat pump system. This can result in a total failure of the heat pump. The following measures must be observed to avoid this:

- Compliance with the water properties and water quality
- Flushing of the hydraulic system
- Maintenance interval of the dirt traps
- If silting or ferromagnetic particles are to be expected in the hydraulic network, dirt separators or magnetite separators must be installed on-site before the medium enters the heat pump. The maintenance intervals must be defined by a suitably qualified person.

7.3 Procedure

The heat pump is commissioned via the heat pump manager. Settings should be made in compliance with the heat pump manager's instructions.

If an overflow valve is fitted to ensure a minimum heating water flow, the overflow valve must be set in accordance with the requirements of the respective heating system. Incorrect adjustment can lead to faulty operation and increased energy consumption. We recommend carrying out the following procedure to set the overflow valve correctly:

Close all heating circuits that may also be closed during operation (depending on how the heat pump is being used) so that the most unfavourable operating status with regard to the water flow is achieved. This normally means the heating circuits of the rooms on the south and west sides of the building. At least one heating circuit must remain open (e.g. bathroom).

The overflow valve should be opened far enough to produce the maximum temperature spread between the heat flow and heat return flow, listed in the following table, for the current heat source temperature. The temperature spread should be measured as close as possible to the heat pump. The heating element of mono energy systems should be disconnected during commissioning.

Heat source temperature		Max. temperature spread between heating flow and return flow
from	to	
-20 °C	-15 °C	4 K
-14 °C	-10 °C	5 K
-9 °C	-5 °C	6 K
-4 °C	0 °C	7 K
1 °C	5 °C	8 K
6 °C	10 °C	9 K
11 °C	15 °C	10 K
16 °C	20 °C	11 K
21 °C	25 °C	12 K
26 °C	30 °C	13 K
31 °C	35 °C	14 K

At heating water temperatures under 7 °C, commissioning is not possible. The water in the buffer tank must be heated with the 2nd heat generator to at least 22 °C.

To ensure problem-free commissioning, the following procedure is to be implemented:

- 1) Close all consumer circuits.
- 2) Ensure that the heat pump has the correct water flow.
- 3) Select "Winter" mode on the heat pump manager.
- 4) In the special functions menu, start the "Commissioning" program.
- 5) Wait until a return temperature of at least 25 °C has been reached.
- 6) Now slowly reopen the heating circuit valves in succession so that the heating water flow rate is constantly raised by slightly opening the respective heating circuit. The heating water temperature in the buffer tank must not be allowed to drop below 22 °C during this process. This ensures that the heat pump can be defrosted at any time.
- 7) When all heating circuits are fully open and a return temperature of at least 22 °C is maintained, the commissioning is complete.

i NOTE

Operating the heat pump at low system temperatures may cause the heat pump to break down completely.

8 Cleaning/maintenance

8.1 Care

To protect the paintwork, avoid leaning anything against the unit or putting objects on the unit. The outdoor components of the heat pump can be wiped with a damp cloth and commercially available domestic cleaner.

i NOTE

Never use cleaning agents containing sand, soda, acid or chloride, as these can damage the surfaces.

To prevent faults due to sediment in the heat exchanger of the heat pump, ensure that the heat exchanger in the heating system cannot be contaminated. We recommend protecting the evaporator by installing a bird guard in the inlet duct. At least 80% of the cross section should be open. Should operating malfunctions due to contamination still occur, however, the system should be cleaned as described below.

8.2 Cleaning the heating system

i NOTE

Pressure relief devices must be checked and maintained regularly.

i NOTE

The integrated dirt trap must be cleaned at regular intervals.

The maintenance intervals should be defined according to the degree of soiling in the system. The filter insert should also be cleaned.

For cleaning, the heating circuit must be made pressureless in the vicinity of the dirt trap, the filter compartment unscrewed, and the filter insert removed and cleaned. Assembly carried out in reverse order requires attention to correct assembly of the screen inserts and tightness of the screw joints.

The ingress of oxygen into the heating water circuit may result in the formation of oxidation products (rust), particularly if steel components are used. These enter the heating system via the valves, the circulating pumps and/or plastic pipes. A diffusion-resistant installation is therefore essential, especially with regard to the piping of underfloor heating systems.

i NOTE

We recommend the installation of a suitable corrosion protection system to prevent the formation of deposits (e.g. rust) in the condenser of the heat pump.

Residue from lubricants and sealants may also contaminate the heating water.

In the event of severe contamination leading to a reduction in the performance of the liquefier in the heat pump, the system must be cleaned by a heating technician.

Based on current information, we recommend using a 5% phosphoric acid solution for cleaning purposes. If cleaning

needs to be performed more frequently, a 5% formic acid solution should be used.

In both cases, the cleaning fluid should be at room temperature. Rinsing the heat exchanger against the normal flow direction is recommended.

To prevent acidic cleaning agents from entering the heating system circuit, we recommend connecting the flushing device directly to the flow and return of the liquefier of the heat pump.

It is then important that the system be thoroughly flushed using appropriate neutralising agents to prevent any damage from being caused by cleaning agent residue remaining in the system.

Acids must be used with care and the regulations of the employers liability insurance associations must be adhered to.

The instructions of the cleaning agent manufacturer must always be observed.

8.3 Cleaning the air system

The air ducts, evaporator, ventilator and condensate drain should be cleaned of contamination (leaves, twigs, etc.) before each new heating period. To do this, the heat pump must be opened at the side. The bottom section should be opened first, followed by the top section.

⚠ CAUTION!

Before opening the unit, ensure that all electric circuits are disconnected from the power supply.

Remove and rehang the side panel assemblies, as described in Chapter 4.

To prevent the evaporator and the condensate tray from being damaged, do not use hard or sharp objects when cleaning.

9 Faults/troubleshooting

This heat pump is a quality product and is designed for trouble-free operation. Should a fault occur, however, it will be indicated on the heat pump manager display. In this case, consult the "Faults and troubleshooting" page in the operating instructions of the heat pump manager.

If you cannot correct the fault yourself, please contact your after-sales service technician.

10 Decommissioning/disposal

Before removing the heat pump, disconnect it from the power source and close all valves. The heat pump must be dismantled by trained personnel. Observe all environmental requirements regarding the recovery, recycling and disposal of materials and components in accordance with all applicable standards. Particular attention should be paid to the proper disposal of refrigerants and refrigerant oils.

i NOTE

Use suitable transport devices.

11 Device Information

1	Type and order code		LA 1422C
2	Design		
2.1	Heat source		Air
2.2	Seasonal coefficient of performance (COP) average climate 35 °C/55 °C		179 %/135 %
2.3	Controller		WPM Touch
2.4	Heat generator installation location		Outside
2.5	Heat source installation location		Outside
2.6	Thermal energy metering		Integrated
2.7	Performance levels		2
3	Operating limits		
3.1	Heating water flow / return ¹	°C	up to 60 ± 2K/from 22
3.2	Air (heating) ¹	°C	-22 to +35
3.3	Cooling water flow	°C	+7 to +20
3.4	Air (cooling)	°C	+15 to +45
4	Flow²/sound		
4.1	Heating water flow rate internal pressure differential		
	Nominal flow rate in accordance with 14511A7/W35 ... 30	m ³ /h / Pa	1.95/12900
	A7/W45 ... 40	m ³ /h / Pa	1.85/11500
	A7/W55 ... 47	m ³ /h / Pa	1.10/4800
	Minimum heating water flow	m ³ /h	1.10/4800
4.2	Cooling water flow rate/internal pressure differential		
	Nominal flow rate in accordance with EN14511A35/W18... 23	m ³ /h / Pa	3.3/37000
	Minimum cooling water flow	m ³ /h / Pa	1.95/12900
4.3	Sound power level in accordance with EN12102 with A7/W55indoors/outdoors ³⁾		
	Normal operation	dB(A)	--/63
	Reduced operation ⁴	dB(A)	--/--
4.4	Sound pressure level at a distance of 1 m outdoors ^{3 5}	dB(A)	55
4.5	Air flow with external static pressure differential	m ³ /h / Pa m ³ /h / Pa	5500/0 4000/25
5	Dimensions, weight and filling quantities		
5.1	Unit dimensions ⁶	H x W x D mm	1785 x 825 x 1000
5.2	Unit connections for heating	Inches	1 1/4" thread
5.3	Weight of heat pump	ka	298
5.4	Weight of the transportable unit(s) incl. packaging	kg	321
5.5	Refrigerant/total filling weight	Type/kg	R410A / 5.4
5.6	GWP value/CO ₂ equivalent	--- / t	2088/11
5.7	Refrigeration circuit hermetically sealed		Yes
5.8	Lubricant/total filling quantity	Type/litres	Polyolester (POE) / 2.48
5.9	Volume of heating water in the indoor component	litres	3.8
6	Electrical connection		
6.1	Supply voltage / fusing / RCD type		3~/PE 400V (50Hz) / C16A / B
6.2	Control voltage / fusing / RCD type		1~/N/PE 230V (50Hz) / C13A / A
6.3	Degree of protection according to EN 60 529		IP 24
6.4	Starting current limiter		Soft starter
6.5	Starting current	A	19
6.6	Nominal power consumption A2 W35 / max. power consumption ²	kW	4.7/8.0
6.7	Nominal current A2/W35 / cos φ	A / ---	8.5/0.8
6.8	Power consumption of fan	W	up to 500
7	Complies with the European safety regulations		7

8 Additional model features				
8.1	Type of defrosting		Reverse cycle	
8.2	Condensate tray frost protection/water in unit is protected from freezing ⁸		Yes	
8.3	Max. operating overpressure (heat sink)	bar	3.0	
9 Heat output/COP ^{2 4}				
9.1	Heat output/coefficient of performance (COP)		EN 14511	
			1	2
	at A-7/W35	kW / ---	7.4/3.2	13.5/3.1
	at A2/W35	kW / ---	9.4/4.1	15.9/3.7
	at A7/W35	kW / ---	11.5/5.0	(20.9/4.7) ⁹
10 Cooling capacity/coefficient of performance (COP) ^{2 3}				
10.1	Cooling capacity/coefficient of performance with minimum cooling water flow, see 4.3		EN 14511	
10.2			1	2
	at A27/W18	kW / ---	10.4/4.0	21.0/3.6
	at A27/W7	kW / ---	6.8/2.7	16.0/2.8
	at A35/W18	kW / ---	10.3/4.0	19.3/2.9
	at A35/W7	kW / ---	6.5/2.3	14.8/2.3

1. For air temperatures between -22°C and -5°C, flow temperature increasing from 45°C to 60°C.

2. This data indicates the size and capacity of the system according to EN 14511. For an analysis of the economic and energy efficiency of the system, the bivalence point and the regulation should be taken into consideration. These figures are only achieved with clean heat exchangers. Instructions for care, commissioning and operation can be found in the relevant sections of the installation and operation instructions. The specified values have the following meaning, e.g. A2/W35: Heat source temperature 2 °C and heating water flow temperature 35 °C.

3. Tone incorporation in accordance with DIN 45681 Table1 ≤3 dB

4. The heat output and COP is reduced by approx. 5 % in lower operation.

5. The specified sound pressure level represents the free sound area level. The measured value can vary by up to 16 dB(A) depending on the installation location.

6. Note that additional space is required for pipe connections, operation and maintenance.

7. see CE declaration of conformity

8. The heat circulating pump and the heat pump manager must always be ready for operation. The heat output and COP is reduced by approx. 5 % in lower operation.

9. Special operation, normal operation above 5 °C outside temperature 1 compressor operation

12 Product information as per Regulation (EU) No 813/2013, Annex II, Table 2

Information requirements for heat pump space heaters and heat pump combination heaters							
Model		LA1422C					
Air-to-water heat pump		yes					
Water-to-water heat pump		no					
Brine-to-water heat pump		no					
Low-temperature heat pump		no					
Equipped with a supplementary heater		no					
Heat pump combination heater		no					
Parameters shall be declared for medium-temperature application, except for low-temperature heat pumps. For low-temperature heat pumps, parameters shall be declared for low-temperature application.							
Parameters shall be declared for average climate conditions:							
Item	Symbol	Value	Unit	Item	Symbol	Value	Unit
Rated heat output (*)	P_{rated}	12	kW	Seasonal space heating energy efficiency	η_s	135	%
Declared capacity for heating four part load at indoor temperature 20°C and outdoor temperature T_j				Declared coefficient of performance or primary energy ratio for part load at indoor temperature 20 °C and outdoor temperature T_j			
$T_j = -7^\circ\text{C}$	P_{dh}	13,6	kW	$T_j = -7^\circ\text{C}$	COP_d	2,28	-
$T_j = +2^\circ\text{C}$	P_{dh}	9,2	kW	$T_j = +2^\circ\text{C}$	COP_d	3,36	-
$T_j = +7^\circ\text{C}$	P_{dh}	11,5	kW	$T_j = +7^\circ\text{C}$	COP_d	4,39	-
$T_j = +12^\circ\text{C}$	P_{dh}	13,1	kW	$T_j = +12^\circ\text{C}$	COP_d	5,40	-
$T_j = \text{bivalent temperature}$	P_{dh}	12,4	kW	$T_j = \text{bivalent temperature}$	COP_d	2,04	-
$T_j = \text{operation limit temperature}$	P_{dh}	12,4	kW	$T_j = \text{operation limit temperature}$	COP_d	2,04	-
For air-to-water heat pumps				For air-to-water heat pumps:			
$T_j = -15^\circ\text{C}$ (if TOL < -20°C)	P_{dh}	-	kW	$T_j = -15^\circ\text{C}$ (if TOL < -20°C)	COP_d	-	-
Bivalent temperature	T_{biv}	-10	°C	For air-to-water heat pumps: Operation limit temperature	TOL	-10	°C
Cycling interval capacity for heating	P_{cyc}	-	kW	Cycling interval efficiency	COP_{cyc}	-	-
Degradation co-efficient (**)	C_{dh}	0,99	-	Heating water operating limit temperature	WTOL	60	°C
Power consumption in modes other than active mode				Supplementary heater			
Off mode	P_{OFF}	0,020	kW	Rated heat output (*)	P_{sup}	0	kW
Thermostat-off mode	P_{TO}	0,020	kW	Type of energy input	electrical		
Standby mode	P_{SB}	0,020	kW				
Crankcase heater mode	P_{CK}	0,000	kW				
Other items							
Capacity control		fixed		For air-to-water heat pumps: Rated air flow rate, outdoors	-	4000	m ³ /h
Sound power level, indoors/ outdoors	L_{WA}	- / 63	dB	For water-/brine-to-water heat pumps: Rated brine or water flow rate, outdoor heat exchanger	-	--	m ³ /h
Emissions of nitrogen oxides	NO_x	-	mg/kWh				
For heat pump combination heater:							
Declared load profile		-		Water heating energy efficiency	η_{wh}	-	%
Daily electricity consumption	Q_{elec}	-	kWh	Daily fuel consumption	Q_{fuel}	-	kWh
Contact details	Glen Dimplex Deutschland GmbH, Am Goldenen Feld 18, 95326 Kulmbach						
(*) For heat pump space heaters and heat pump combination heaters, the rated output P_{rated} is equal to the design load for heating $P_{designh}$, and the rated heat output of a supplementary capacity for heating $sup(T_j)$.							
(**) If C_{dh} is not determined by measurement then the default degradation is $C_{dh} = 0,9$							
(--) not applicable							

13 Dimension Drawings

13.1 Dimension Drawing

- 1 Heating water flow
- Heat pump outlet
- 1 1/4" external thread
- 2 Heating water return flow
- Heat pump inlet
- 1 1/4" external thread
- 3 Condensate drain
- (optional lateral connections)
- 4 Electric wires
- (optional lateral connections)

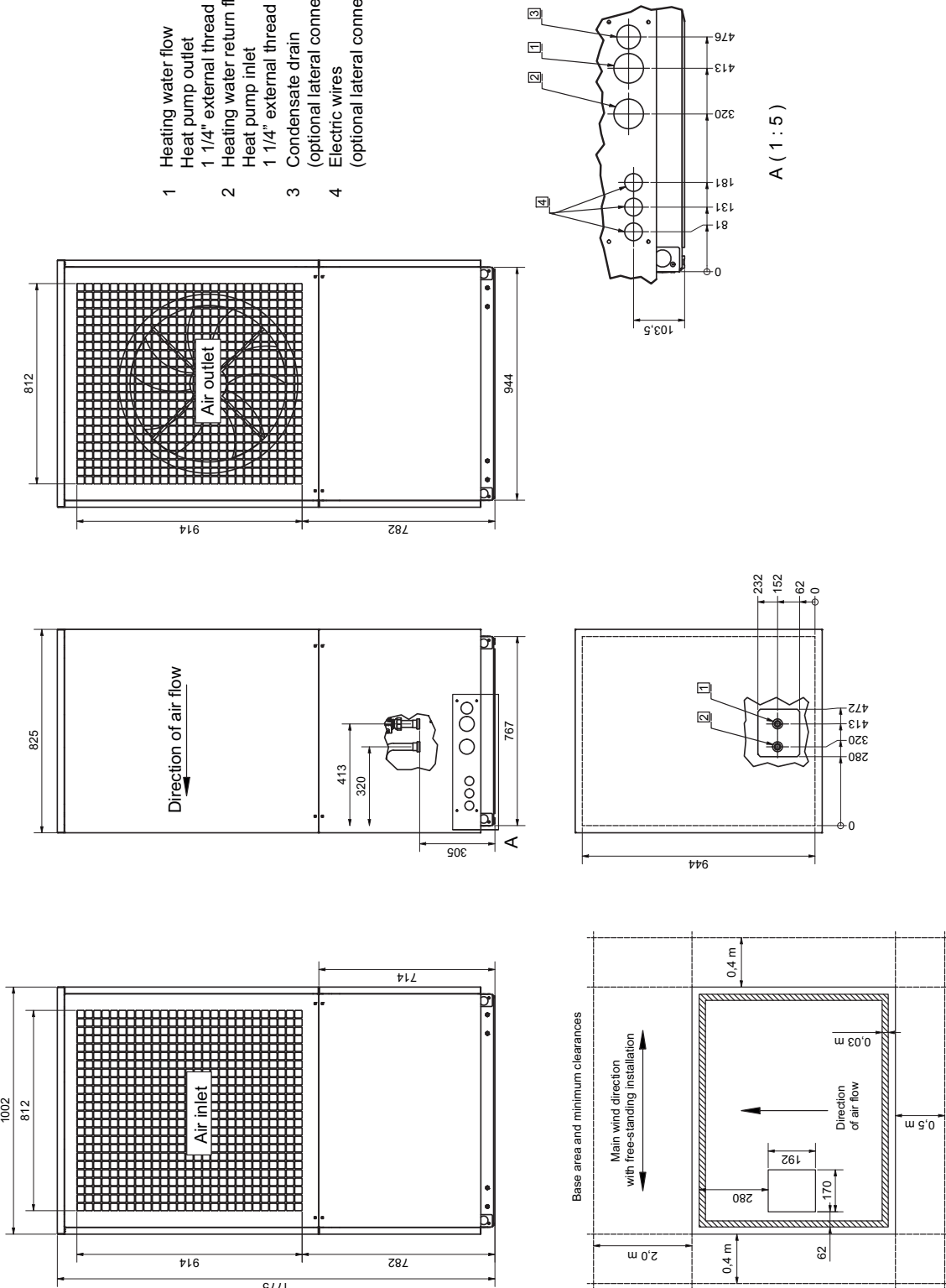

14 Diagrams

14.1 Characteristic curves for heating operation

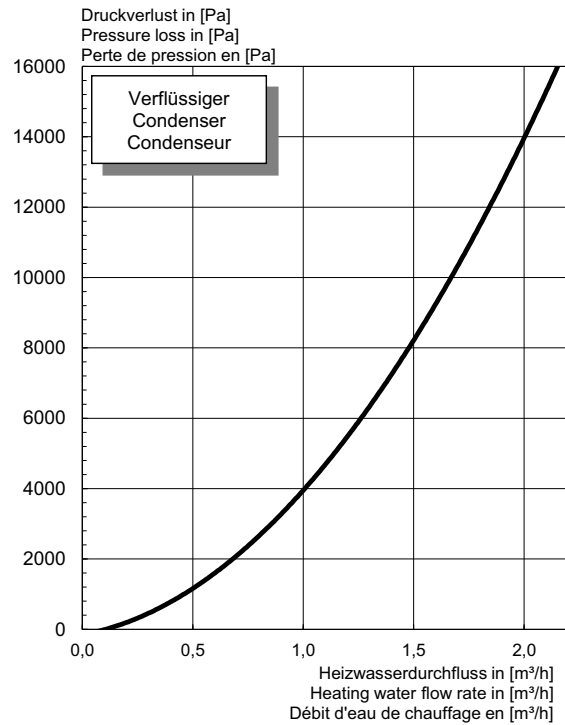
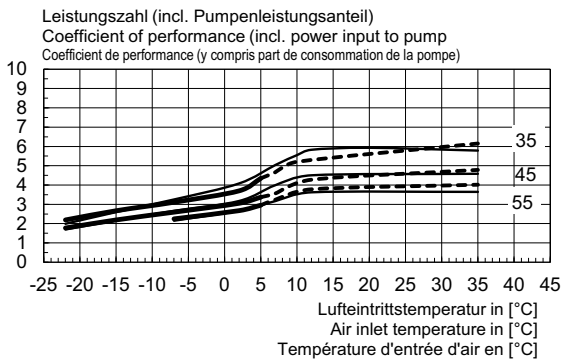
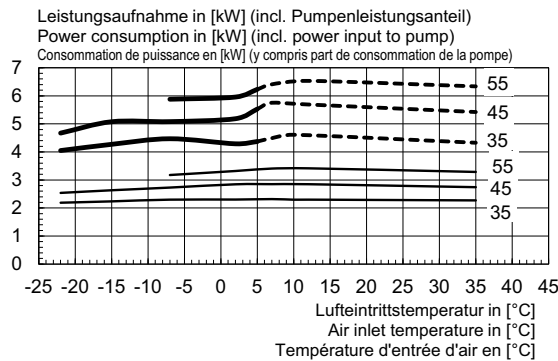
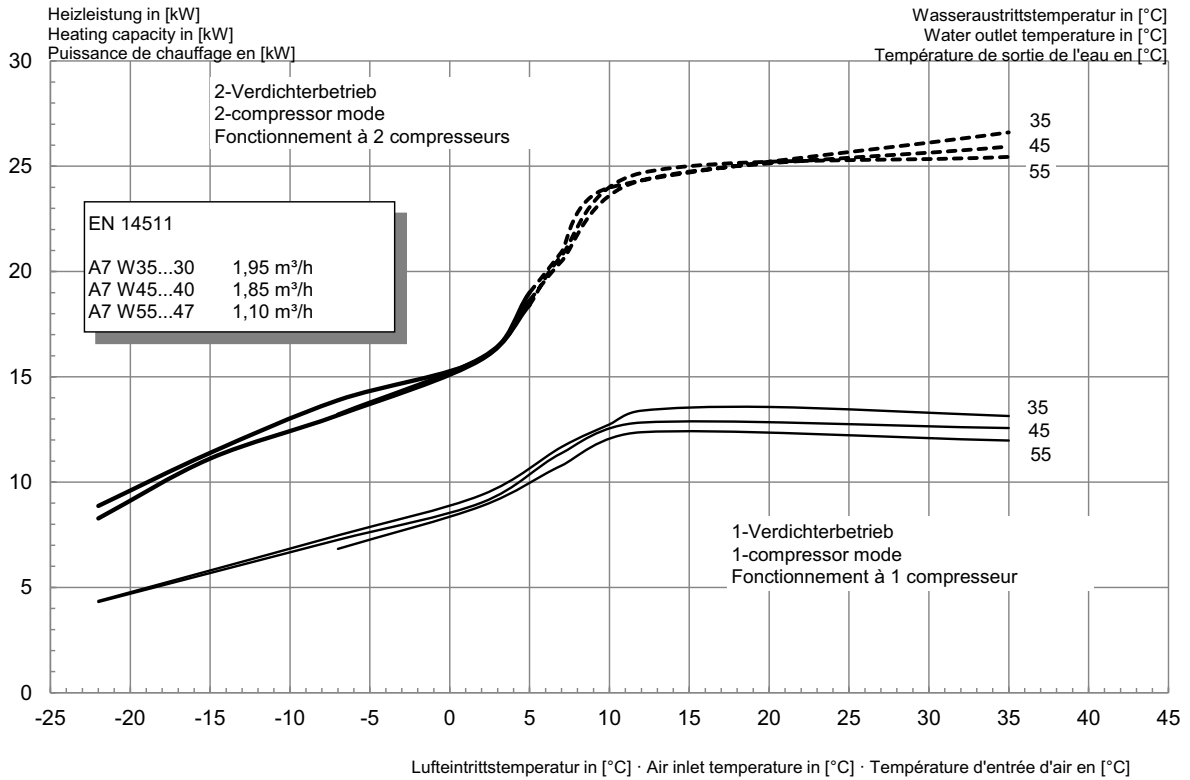

14.2 Characteristic curves for cooling operation

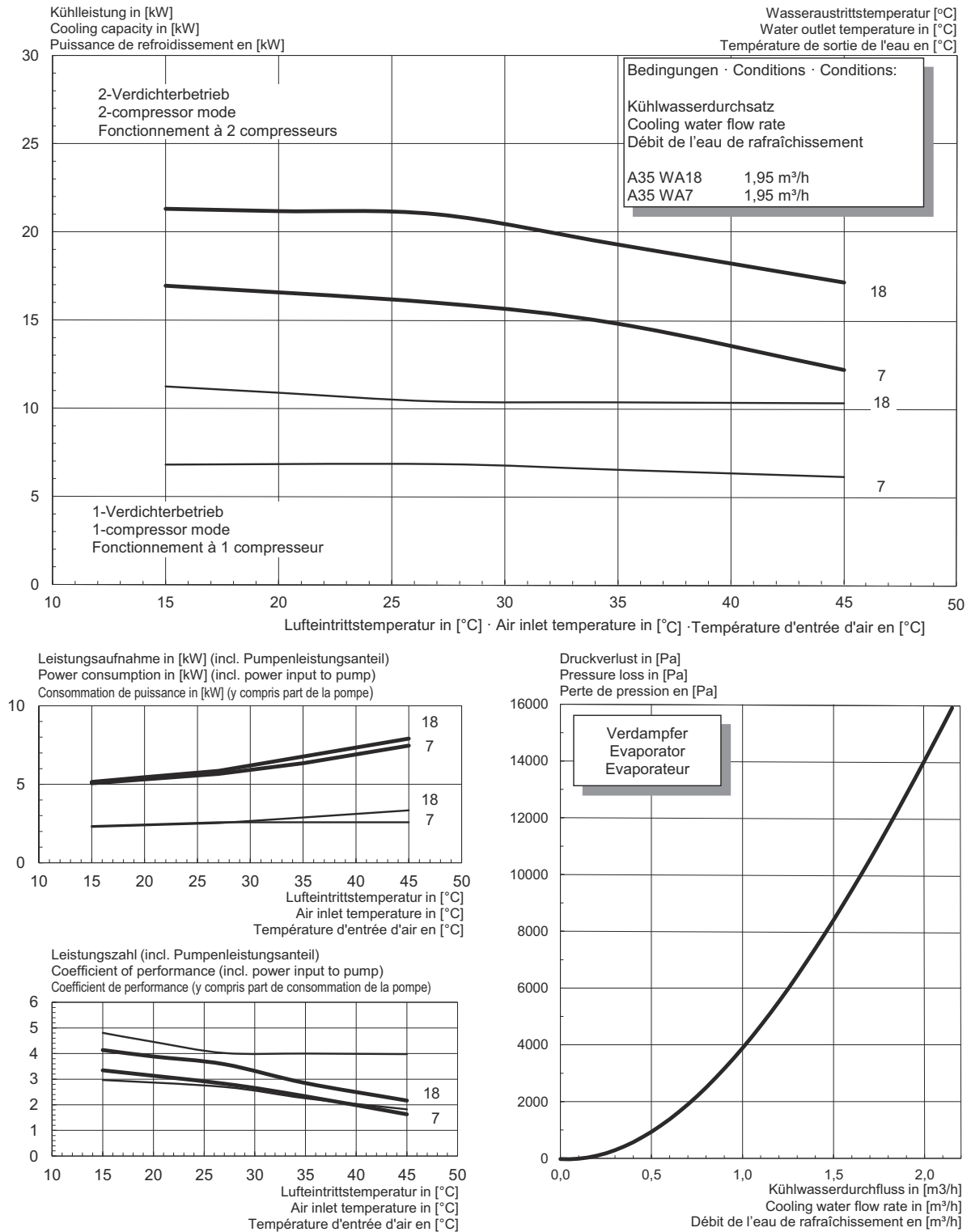

14.3 Operating limits diagram heating

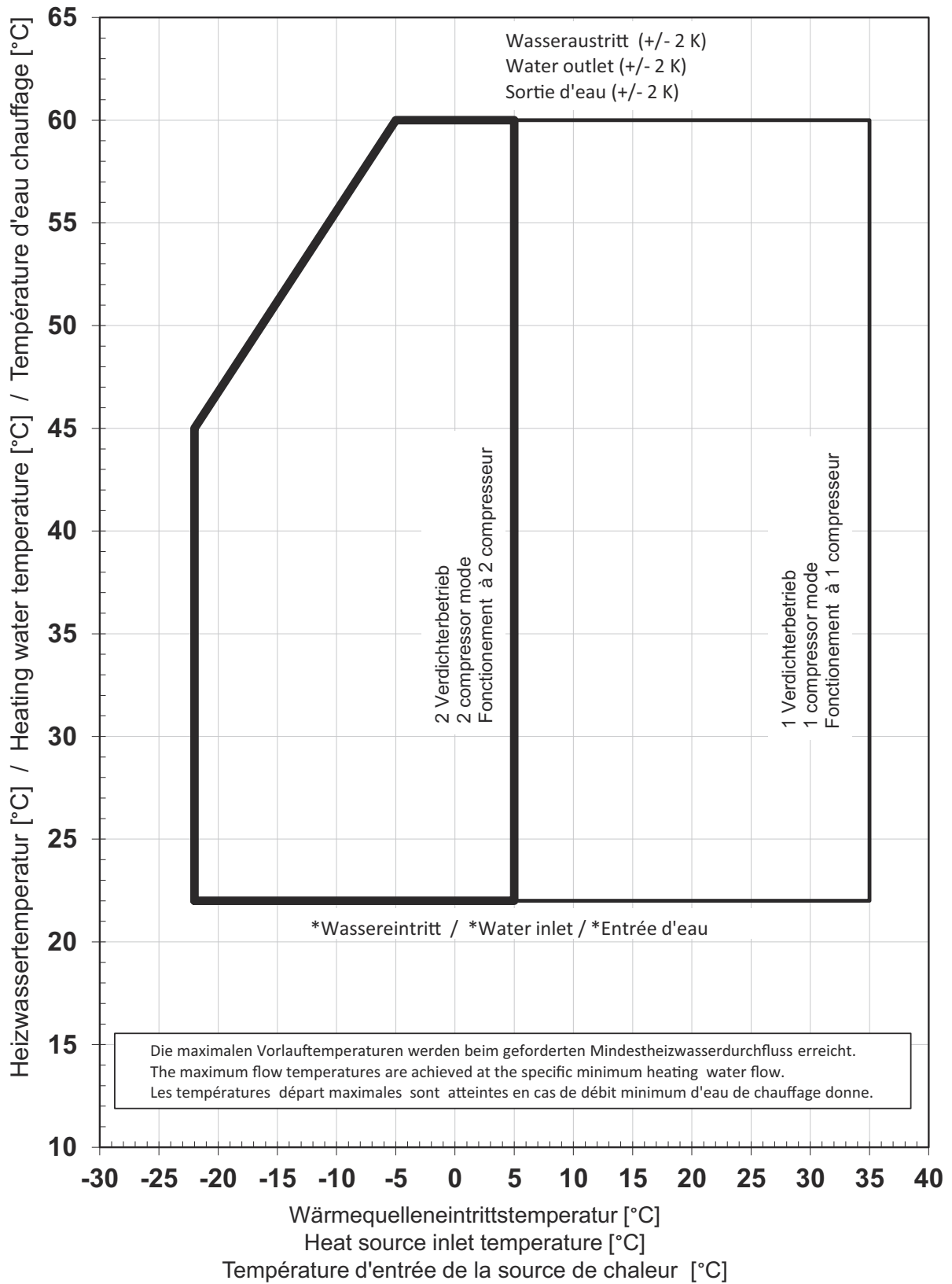

*Bei Luft/Wasser-Wärmepumpen stellt die minimale Heizwassertemperatur die Mindest-Rücklauftemperatur dar

*For air-to-water heat pumps the minimum heating water temperature is the minimum return temperature

*Sur les pompes à chaleur air / eau, la température minimale d'eau de chauffage correspond à la température retour minimale

14.4 Operating limits diagram cooling

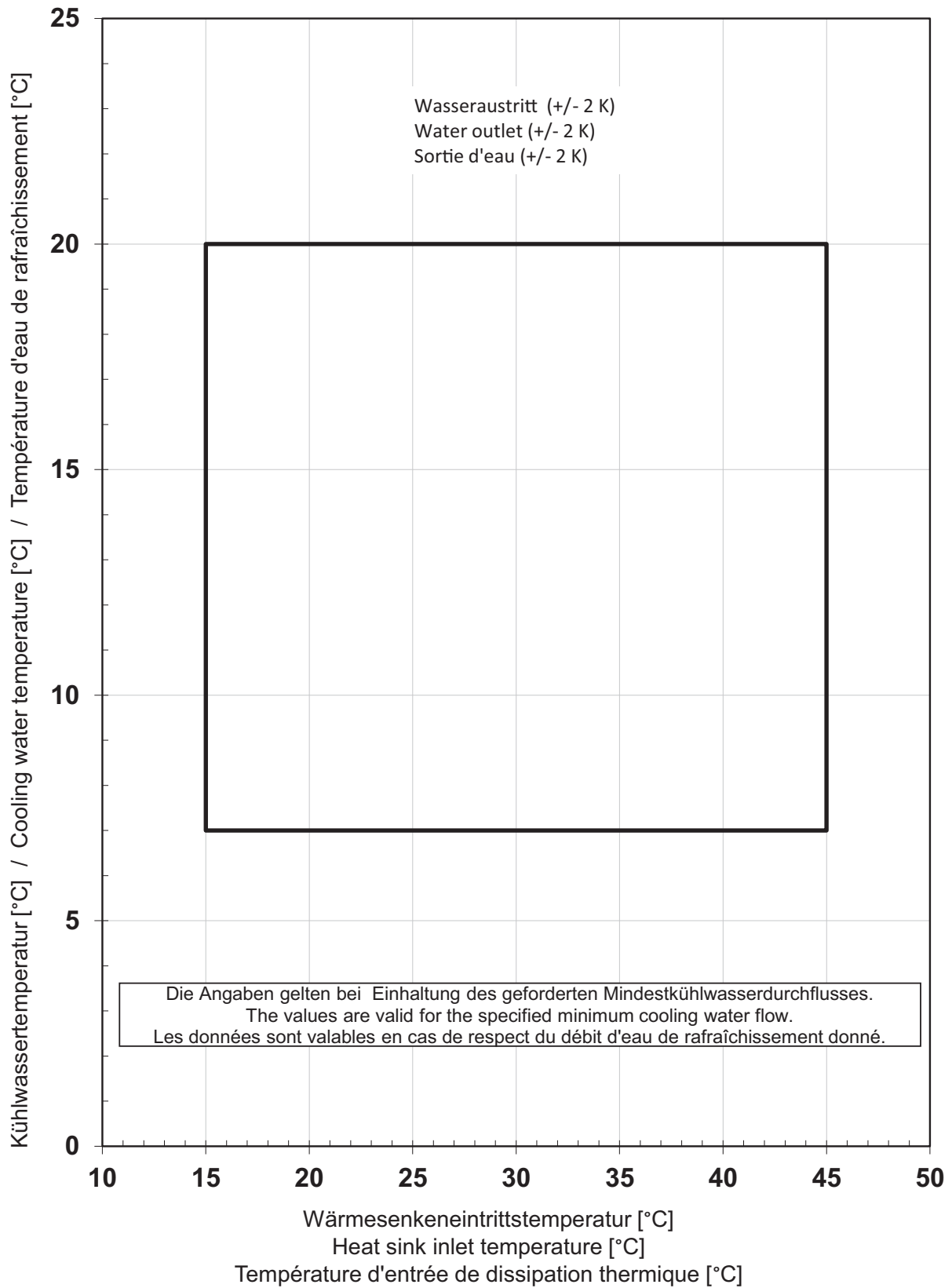

15 Integration diagram

15.1 Hydraulic integration diagrams

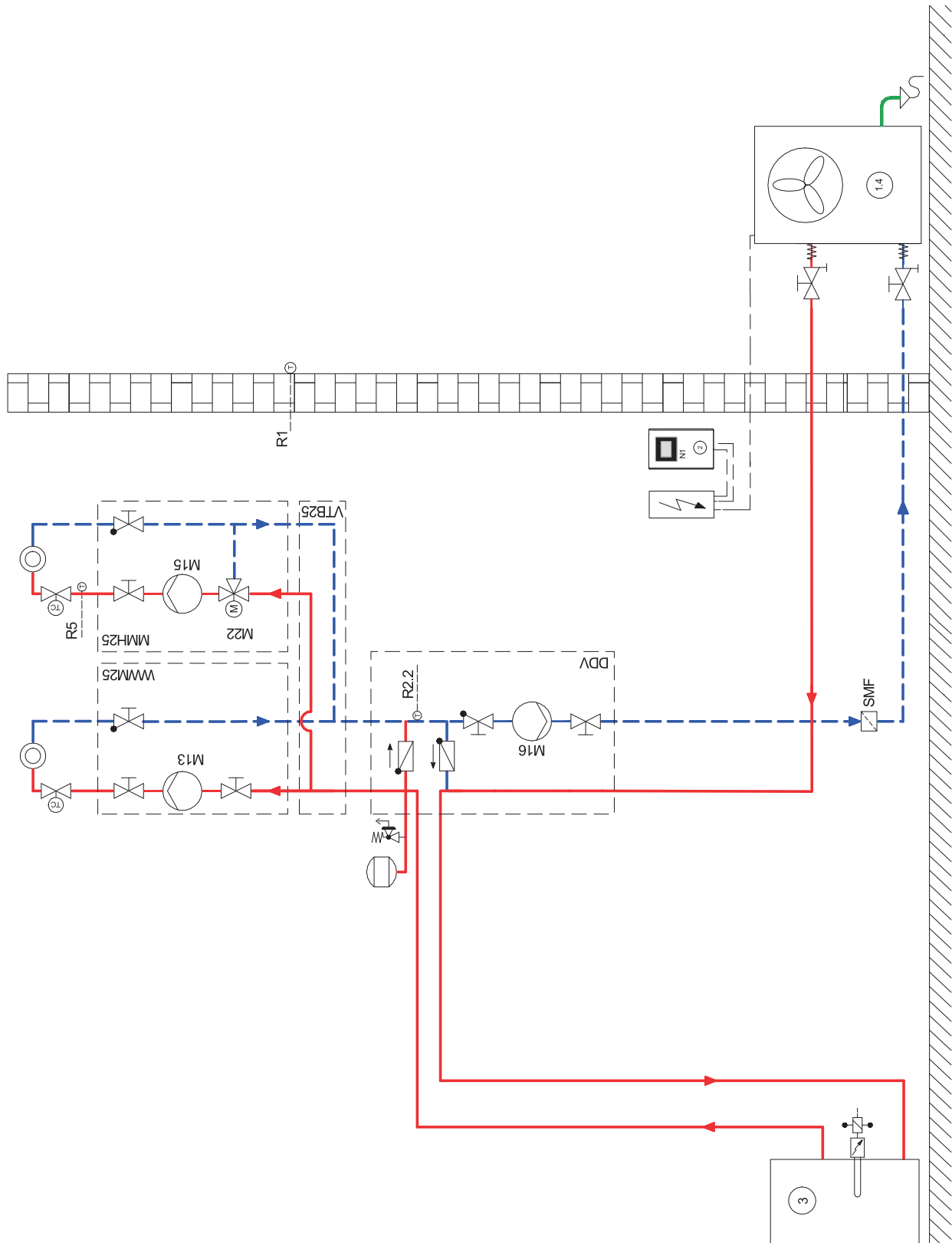

i NOTE

The hydraulic integration diagram is an example and intended only as an aid. The system requires professional and safety-approved layout by a specialist planner. All information in the section on installation and the corresponding safety notes must be observed at all times.



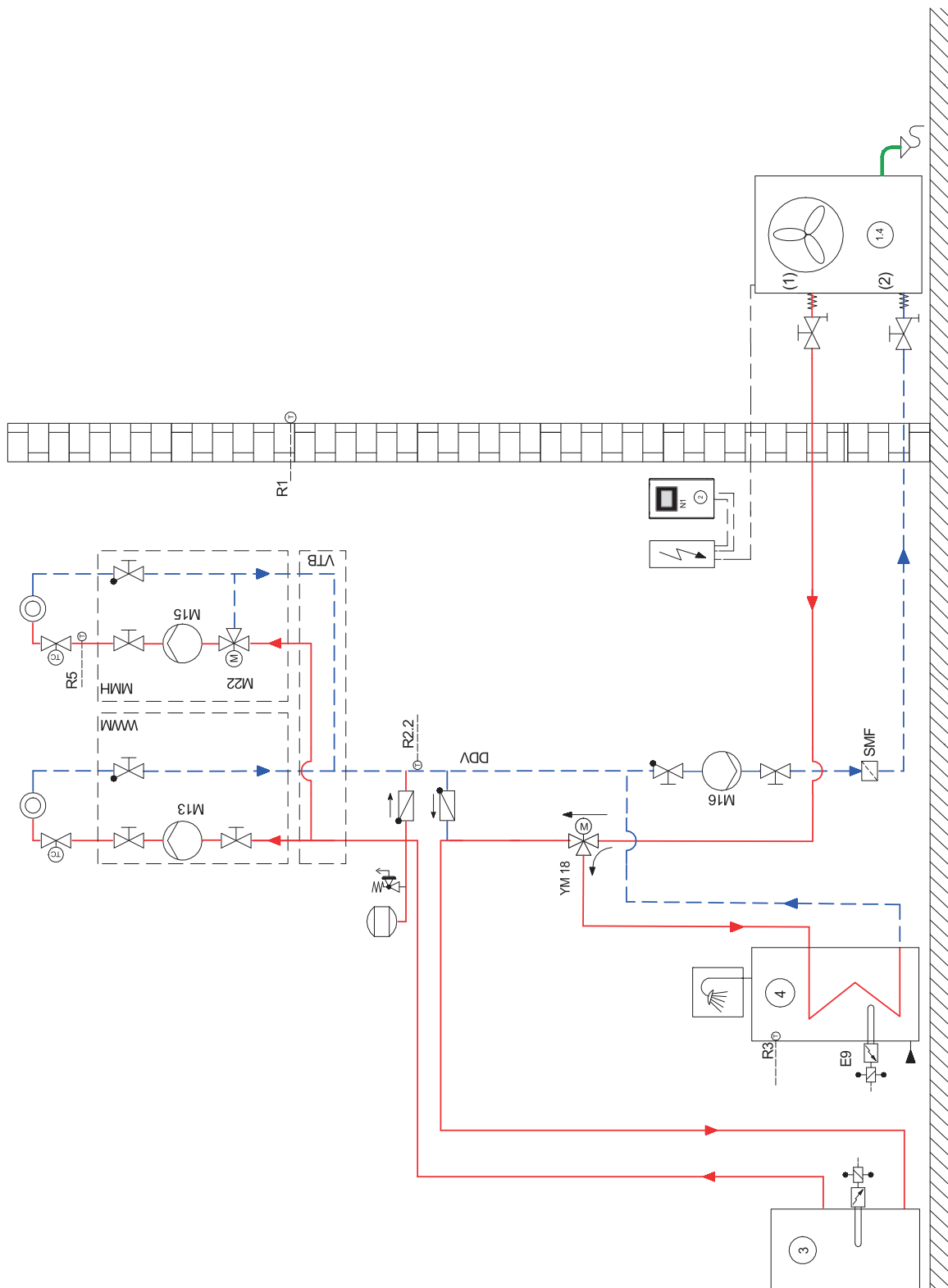















15.2 Hydraulic integration diagrams



i NOTE

The hydraulic integration diagram is an example and intended only as an aid. The system requires professional and safety-approved layout by a specialist planner. All information in the section on installation and the corresponding safety notes must be observed at all times.

15.3 Legend

	Isolating valve
	Safety valve combination
	Circulating pump
	Expansion vessel
	Room-temperature controlled valve
	Isolating valve with check valve
	Isolating valve with drainage
	Heat consumer
	Four-way reversing valve
	Temperature sensor
	Flexible connection hose
	Check valve
	Three-way mixer
	Dirt trap (optional)
	Air-to-water heat pump
	Heat pump manager
	Buffer tank connected in series
	Domestic hot water cylinder
E9	Flange heater domestic hot water
E10.1	Immersion heater
M13	Heat circulating pump main circuit
M15	Heat circulating pump for 2nd heating circuit
M16	Auxiliary circulating pump
M22	Mixer for 2nd heating circuit
N1	Heat pump manager
R1	External wall sensor
R2.2	Demand sensor
R3	Domestic hot water sensor
R5	Temperature sensor for 2nd heating circuit
SMF	Dirt trap (optional)
YM18	Reversing valve domestic hot water

16 Declaration of Conformity

You can find and download the current CE conformity declaration at:

<https://dimplex.de/la1422c>



Glen Dimplex Deutschland

Head office

Glen Dimplex Deutschland GmbH
Am Goldenen Feld 18
D-95326 Kulmbach

T +49 9221 709-101
F +49 9221 709-339
info@dimplex.de
www.dimplex.de

On site service

After-sales service, technical support and spare parts. Assistance before and after installation of your equipment

T +49 9221 709-545
F +49 9221 709-924545
Mon - Thu: 7:00 to 17:00
Fri: 7:00 to 15:00
service@dimplex.de

Outside these opening times,
in an emergency you can contact
our 24/7 hotline.

Request after-sales service on the internet:
www.dimplex.de/dimplex-service