

wall mounting socket outlet - housing dimensions 126x83



Product description	
BALS-Prd.-Nr	1149
EAN	4024941011495
Product category	Wall mounting socket outlet
Current	32A
Number of poles	4p
Arrangement of phases	3P+PE
Position of earth contact	6 h
Voltage	380 - 415V~
Frequency	50/60Hz

Product description	
Protection degree	IP67
Colour code	red RAL 3000
Colour of appliance	Hinged lid red RAL 3000, Housing bottom grey RAL 7035, Housing top grey RAL 7035, Bayonet ring grey RAL 7035
Connection design	with screw terminal
Maximum conductor size	10,0 qmm
Cable entry	1xM25 top, 2xM25 bottom
Height	161mm
Width	94mm
Depth	139mm
Dimension of enclosure	126x83 mm (HxW)
Material of enclosure	Polyamide
Contacts	The contact carrier is made of polyamide, The contacts are brass

Additional technical properties	
	The cable entry is one at top open and two at bottom closed
	Lower part of housing rotatable by 180°
	4 cut out fixing holes in the lower part of housing

Logistics data	
Weight/pcs	0.44 kg / Piece

Logistics data	
Packaging	Bag
Content amount	1 ST
EAN	4024941011495
Length	139 mm
Width	94 mm
Height	161 mm
Weight	0.441 kg
Volume	2,103.626 ccm
Packaging	Carton
Content amount	10 ST
EAN	4024941827355
Length	335 mm
Width	283 mm
Height	268 mm
Weight	4.75 kg
Volume	21,937.5 ccm

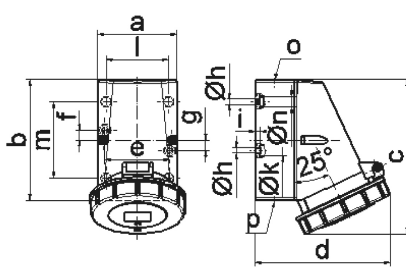

Ampere	16	16	16	32	32	32
Polzahl	3	4	5	3	4	5
a	64,0	75,0	75,0	83,0	83,0	83,0
b	87,0	100,0	100,0	126,0	126,0	126,0
c	115,0	130,0	130,0	160,0	160,0	160,0
d	103,0	110,0	115,0	129,0	129,0	135,0
e	51,0	59,0	59,0	68,0	68,0	68,0
f	20,0	11,0	11,0	11,0	11,0	11,0
g	20,0	-	-	-	-	-
h ø	4,1	5,1	5,1	5,5	5,5	5,5
i	4,5	4,5	4,5	6,5	6,5	6,5
k ø	8,0	10,0	10,0	12,0	12,0	12,0
l	-	-	-	65,0	65,0	65,0
m	-	-	-	80,0	80,0	80,0
n ø	-	-	-	10,0	10,0	10,0
o	M20	M20	M20	M25	M25	M25
p	für M20	für M20	für M20	2 x M25	2 x M25	2 x M25
Leiter mm ² min	1,5	1,5	1,5	2,5	2,5	2,5
Leiter mm ² max	4	4	4	10	10	10

1 MB 13