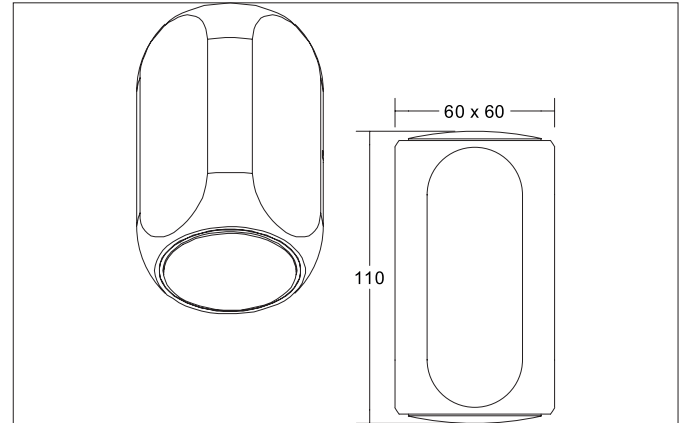

PENCILwall LED surface-mounted wall light, direct / indirect, trailing edge dimmable

Article no. 10114173

Light.
For Generations.**Tender**

LED surface-mounted wall light, direct / indirect, trailing edge dimmable, Rectangular. Luminaire length 60.0 mm, Luminaire width 60.0 mm, Height 110.0 mm Weight 0.544 kg, with rotationssymmetrical, deep, wide distributed light intensity. optimal light distribution due to a plastic, transparent cover. Luminous flux 460 lm, Power 2 x 4 W, System Efficiency 58 lm/W, Light colour warm white, Correlated color temperature (CCT) 3.000 K, Colour rendering index CRI > 90, Housing material: Aluminium / Glass, Colour: White structure, Permissible ambient temperature (ta): -20 °C - +25 °C, Protection class (EN 61140): I, Degree of protection (DIN EN 60529): IP20, .For direct connection to mains voltage, Trailing-edge phase dimmable.

Article data	
Article no.	10114173
GTIN	4255752500711
Series name	PENCILwall
Short description	LED surface-mounted wall light, direct / indirect, trailing edge dimmable
Material	Aluminium / Glass
Colour	White
Type of surface	Structure
Shape	Rectangular
Length	60 mm
Width	60 mm
Height	110 mm
Weight	0.544 kg
stamp	UKCA

PENCILwall LED surface-mounted wall light, direct / indirect, trailing edge dimmable

Article no. 10114173

Light.
For Generations.

Lighting technology	
Colour temperature	3.000 K
Light colour	White
Light output	Direct/Indirect
Luminous flux	460 lm
System efficiency	58 lm/W
Colour rendering	CRI > 90
Reflector	Without
Beam angle	70°
Light sharing	Symmetric
Adjustable color temperature	No

Operating technology of the luminaire	
System output	8 W
Voltage type	AC
AC nominal voltage max	230 V
Frequency max	50 Hz
Lamp	LED
Protection class	I
Degree of protection	IP20
Dimmable	Yes
Control	Trailing-edge phase
Bulb change possible	The light source of this luminaire may only be replaced by the manufacturer or a service technician commissioned by him or a similarly qualified person.

Mounting technology	
Mounting method	Surface mounting
Place of installation	Wall-mounted
Adjustability	Not adjustable
Material cover	Plastic, transparent

Packing data	
Gross weight	0.624 kg
Length of packaging	120 mm
Packaging width	100 mm
Packaging height	70 mm
Disposal at end of life	This product must not be disposed of with household waste. You are obliged, to dispose of such electrical waste separately. By disposing of electrical waste and other old or defective electronics separately, you support recycling or other forms of re-use. In that way you help to take care and to avoid that harmful substances get into the environment.