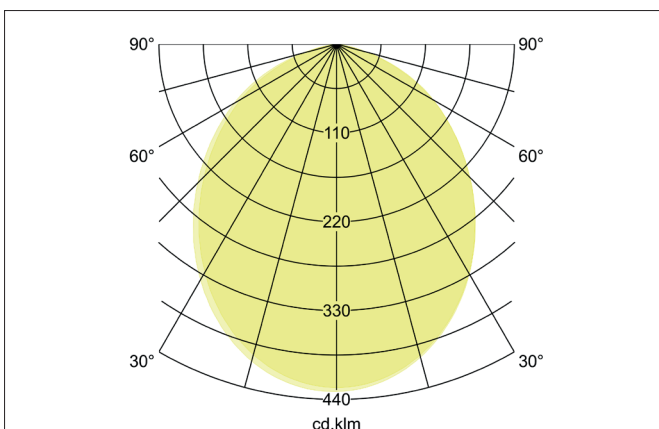
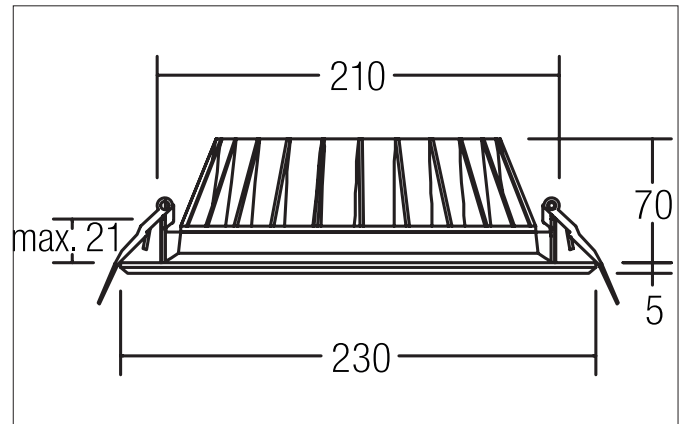

**BOWL MAXI LED recessed downlight**

Article no. 12529074

Light.  
For Generations.**Tender**

LED recessed downlight, Round. Toolless ceiling installation by installation springs. Ceiling cut-out  $\varnothing$  210 mm, Installation depth 70 mm, Outer diameter 230 mm, Weight 0,743 kg, with rotationssymmetrical, deep, wide distributed light intensity. optimal light distribution due to a plastic, opal cover. Luminous flux 3.000 lm, Power 1 x 30 W, Light colour neutral white, Correlated color temperature (CCT) 4.000 K, Colour rendering index CRI > 80, Rated life time L70/B50 at 25 °C: 50.000 h, Housing material: Aluminium / PMMA, Colour: White, Permissible ambient temperature ( $t_a$ ): -20 °C - +25 °C, Protection class (EN 61140): III, Degree of protection (DIN EN 60529): IP20, .For connection to an external driver, which is not included in the scope of delivery of the luminaire. Depending on driver dimmable.

**Product Benefits**

- Recessed downlight in round design made of solid aluminum with opal PMMA cover
- Ceiling cutout 210 mm, outer diameter 230 mm, installation depth 70 mm, luminous flux 2,330 / 3,000 lm, IP20.
- Recessed light emission.
- Dimmable when using a suitable converter.
- Alternatively available in two other sizes.

**BOWL MAXI LED recessed downlight**

Article no. 12529074

Light.  
For Generations.

Article data	
Article no.	12529074
GTIN	4251433917847
Series name	BOWL MAXI
Short description	LED recessed downlight
Material	Aluminium / PMMA
Colour	White
Type of surface	Matt
Shape	Round
Outer diameter	230 mm
Built-in diameter	210 mm
Installation depth	70 mm
Hight	5 mm
Weight	0.743 kg
stamp	UKCA
Conformance	CE, UKCA

Lighting technology	
Colour temperature	4.000 K
Light colour	White
Light output	Direct
Luminous flux	3,000 lm
System efficiency	100 lm/W
Colour rendering	CRI > 80
Reflector	Without
Beam angle	97°
Light sharing	Symmetric
Adjustable color temperature	No

Operating technology of the luminaire	
Voltage type	DC
Current	700 mA
Lamp	LED
Protection class	III
Degree of protection	IP20
Dimmable	Depending on type of control gear
Control	Depending on driver
Bulb change possible	The light source of this luminaire may only be replaced by the manufacturer or a service technician commissioned by him or a similarly qualified person.
Rated life time L70/B50 at 25 °C	50,000 h

Mounting technology	
Mounting method	Recessed mounting
Place of installation	Ceiling-mounted
Adjustability	Not adjustable
Max. ceiling thickness	21 mm
Further references	No cover with thermal insulation material
Material cover	Plastic, opal

**BOWL MAXI LED recessed downlight**

Article no. 12529074



Light.  
For Generations.

Packing data	
Gross weight	1.068 kg
Length of packaging	320 mm
Packaging width	245 mm
Packaging height	100 mm
Disposal at end of life	<p>This product must not be disposed of with household waste. You are obliged, to dispose of such electrical waste separately.</p> <p>By disposing of electrical waste and other old or defective electronics separately, you support recycling or other forms of re-use. In that way you help to take care and to avoid that harmful substances get into the environment.</p>

**BOWL MAXI LED recessed downlight**

Article no. 12529074

Light.  
For Generations.

Accessories	
	Article no.: 17723000 LED converter 700 mA, on/off switchable Power: 1,4 - 31 W Dimensions: 146 mm x 43.5 mm x 30 mm
	Article no.: 17723010 LED converter 700 mA, on/off switchable Power: 1,4 - 31 W Dimensions: 146 mm x 43.5 mm x 30 mm
	Article no.: 17723020 LED converter 700 mA, on/off switchable Power: 1,4 - 31 W Dimensions: 146 mm x 43.5 mm x 30 mm
	Article no.: 17748000 LED converter 700 mA, trailing-edge phase dimmable Power: 1,4 - 32 W Dimensions: 166 mm x 46 mm x 34 mm
	Article no.: 17748010 LED converter 700 mA, trailing-edge phase dimmable Power: 1,4 - 32 W Dimensions: 166 mm x 46 mm x 34 mm
	Article no.: 17748020 LED converter 700 mA, trailing-edge phase dimmable Power: 1,4 - 32 W Dimensions: 166 mm x 46 mm x 34 mm
	Article no.: 17777000 LED converter 700 mA, 1-10 V dimmable (analog) Power: 7 - 36 W Dimensions: 146 mm x 43.5 mm x 30 mm
	Article no.: 17777010 LED converter 700 mA, 1-10 V dimmable (analog) Power: 7 - 36 W Dimensions: 146 mm x 43.5 mm x 30 mm
	Article no.: 17788000 LED converter 700 mA, DALI dimmable (digital) Power: 7 - 38 W Dimensions: 146 mm x 44 mm x 30 mm
	Article no.: 17788010 LED converter 700 mA, DALI dimmable (digital) Power: 7 - 38 W Dimensions: 146 mm x 44 mm x 30 mm

**BOWL MAXI LED recessed downlight**

Article no. 12529074



Light.  
For Generations.

Accessories	
	<p>Article no.: 17788020 LED converter 700 mA, DALI dimmable (digital) Power: 7 - 38 W Dimensions: 146 mm x 44 mm x 30 mm</p>
	<p>Article no.: 17771000 LED converter 700mA, ZigBee dimmable Power: 7 - 36 W Dimensions: 146 mm x 44 mm x 30 mm</p>
	<p>Article no.: 17771010 LED converter 700mA, ZigBee dimmable Power: 7 - 36 W Dimensions: 146 mm x 44 mm x 30 mm</p>
	<p>Article no.: 17771020 LED converter 700mA, ZigBee dimmable Power: 7 - 36 W Dimensions: 146 mm x 44 mm x 30 mm</p>
	<p>Article no.: 17772000 LED converter 700mA, Casambi dimmable Power: 7 - 38 W Dimensions: 146 mm x 44 mm x 30 mm</p>
	<p>Article no.: 17772010 LED converter 700mA, Casambi dimmable Power: 7 - 38 W Dimensions: 146 mm x 44 mm x 30 mm</p>
	<p>Article no.: 17772020 LED converter 700mA, Casambi dimmable Power: 7 - 38 W Dimensions: 146 mm x 44 mm x 30 mm</p>
	<p>Article no.: 17782000 LED converter 700 mA, DALI dimmable, (digital) Power: 3,5 - 38 W Dimensions: 146 mm x 43.5 mm x 22 mm</p>
	<p>Article no.: 17782010 LED converter 700 mA, DALI dimmable, (digital) Power: 3,5 - 38 W Dimensions: 146 mm x 43.5 mm x 22 mm</p>
	<p>Article no.: 17782020 LED converter 700 mA, DALI dimmable, (digital) Power: 3,5 - 38 W Dimensions: 146 mm x 43.5 mm x 22 mm</p>
	<p>Article no.: 3838 Plug &amp; Play extension lead 700 mA Dimensions: 500 mm</p>

## BOWL MAXI LED recessed downlight

Article no. 12529074

Light.  
For Generations.

Accessories	
	Article no.: 3839 Plug & Play extension lead 700 mA  Dimensions: 1,000 mm
	Article no.: 3840 Plug & Play extension lead 700 mA  Dimensions: 2,000 mm