

ORYO-P 101.940.25

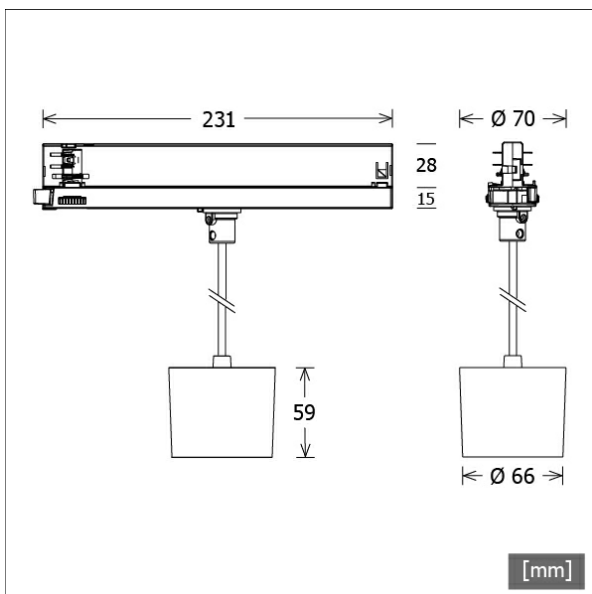

Farbe	Artikelnummer	EAN
schwarz	664084	4043544732163
weiß	664085	4043544732170
silber	664559	4043544736949



Beschreibung

- filigrane Pendelleuchte mit leicht konusförmigem Lichtkopf
- hohe Wartungsfreundlichkeit
- keine UV- und Wärmestrahlung
- Abblendschute und Abblenddekoring als Zubehör erhältlich
- Lichtkopf aus Aluminiumdruckguss
- innovatives Wärmemanagement mit formintegrierter Passivkühlung
- High-Performance Spiegelreflektor aus Aluminium mit präziser symmetrischer Abstrahlcharakteristik für optimale Lichtausbeute und Entblendung
- innenliegender Thermoplast-Frontring in schwarz
- Kabelabhängung schwarz (Länge: 1000 mm, andere Kabellängen auf Anfrage)
- Acrylschutzglas klar
- 3-Phasen-Stromschienenadapter mit integriertem Betriebsgerät

Standardoptionen



Lichttechnik / Normen

Leuchtmittel	LED Spot / CRI 90 / 4000 K
EPREL Lichtquellen	854571
Lebensdauer	L90 B50 50.000 h L80 B50 100.000 h L80 B20 50.000 h
Systemleistung	20.0 W
Leuchten-Lichtstrom	1820 lm
Systemeffizienz	91.00 lm/W
Moduleffizienz	140.95 lm/W
UGR Klasse	≤19
Abstrahlwinkel	25°
Versorgungsspannung	220 - 240 V / 50 - 60 Hz
Schutzklasse	II
Schutzart	IP20

Abmessungen / Gewichte

Außendurchmesser	66 mm
Höhe	59 mm
Durchmesser Lichtkopf	66 mm
Nettogewicht	0.52 kg
Bruttogewicht	0.62 kg

ORYO-P 101.940.25

ORYO-P 101.940.25

Oryo 100 | Pendant (1xLED 20W 940/4000K 1820lm 25°)

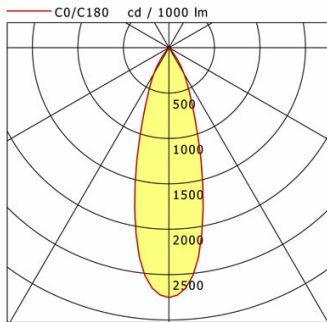

	C0	C90	C180	C270
0°	2753	2753	2753	2753
15°	1403	1403	1403	1403
30°	332	332	332	332
45°	17	17	17	17
60°	7	7	7	7
75°	2	2	2	2
90°	0	0	0	0
cd / 1000 lm				

Offset [m]	Cone width [m]	Illuminance [lx]
3.0	1.63	556.7
6.0	3.26	139.2
9.0	4.89	61.9
12.0	6.53	34.8
15.0	8.16	22.3

η	LED
Efficiency	91 lm/W
Direct/Indirect	↓ 100% / ↑ 0%
System Power	20 W
UGR	X=4H, Y=8H
Reflection factors	70/50/20
UGR C0/C180	19.4
UGR C90/C270	19.4
CIE Flux Codes	97 99 100 100 100
Ra/CRI	>90

LTS

Zubehör



EU 10
Anbau-Stromschiene Professional
(Länge: 1000 mm)



EU 20
Anbau-Stromschiene Professional
(Länge: 2000 mm)



EU 21
Anbau-Stromschiene Professional
(Länge: 3000 mm)



EU 22
Anbau-Stromschiene Professional
(Länge: 4000 mm)



EUE 20
Einbau-Stromschiene Professional
(Länge: 2000 mm)



EUE 21
Einbau-Stromschiene Professional
(Länge: 3000 mm)



EUE 22
Einbau-Stromschiene Professional
(Länge: 4000 mm)



ST-A 10/9000-1-ST
Anbau-Stromschiene ONETrack mit Datenbus
(Länge: 1000 mm)



ST-A 10/9000A-1-ST
Anbau-Stromschiene ONETrack Advance mit Datenbus
(Länge: 1000 mm)



ST-A 20/9000-2-ST
Anbau-Stromschiene ONETrack mit Datenbus
(Länge: 2000 mm)



ST-A 20/9000A-2-ST
Anbau-Stromschiene ONETrack Advance mit Datenbus
(Länge: 2000 mm)



ST-A 30/9000-3-ST
Anbau-Stromschiene ONETrack mit Datenbus
(Länge: 3000 mm)

ORYO-P 101.940.25

Zubehör



ST-A 30/9000A-3-ST
Anbau-Stromschiene ONETrack Advance mit Datenbus
(Länge: 3000 mm)



ST-A 40/9000-4-ST
Anbau-Stromschiene ONETrack mit Datenbus
(Länge: 4000 mm)



ST-A 40/9000A-4-ST
Anbau-Stromschiene ONETrack Advance mit Datenbus
(Länge: 4000 mm)



ST-E 10/9000-1-R
Einbau-Stromschiene ONETrack mit Datenbus
(Länge: 1000 mm)



ST-E 20/9000-2-R
Einbau-Stromschiene ONETrack mit Datenbus
(Länge: 2000 mm)



ST-E 30/9000-3-R
Einbau-Stromschiene ONETrack mit Datenbus
(Länge: 3000 mm)



ST-E 40/9000-4-R
Einbau-Stromschiene ONETrack mit Datenbus
(Länge: 4000 mm)



ZB-AGS 001
Abblendschute



ZB-DAR 001
Abblenddekoring



ZBW 88
Wabenraster