

9002/13-280-110-001 Art. No. 158857

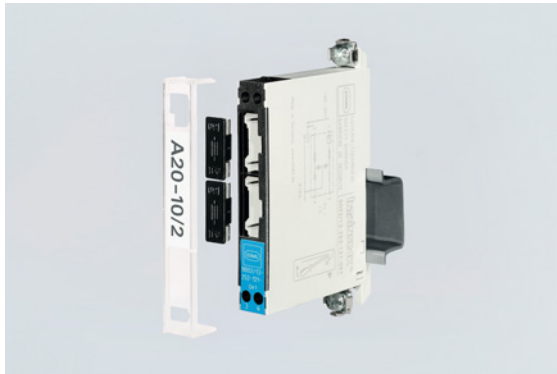

- For the intrinsically safe operation of a wide range of devices, such as HART transmitters, solenoid valves, sensors, zero-potential contacts and many more
- Compact, space-saving devices that are easy to install on a DIN rail
- Quick and efficient installation as barriers can be simultaneously snapped onto DIN rail and connected to ground (ISA - RP112.06)

WebCode **9002A**



The 9002 series INTRINSPAK two-channel zener barriers enable the intrinsically safe operation of virtually all field devices. The comprehensive portfolio and the combination of zener barriers cover a wide variety of signals. The devices are incredibly robust and require very little space. The back-up fuse is a convenient feature as it is standardized for all variants.

Technical Data

Explosion Protection

Application range (Zones)	2
Ex interface zone	0 1 2 20 21 22
IECEX certificate Gas	IECEX PTB 08.0057X
IECEX gas explosion protection	Ex nA [ia Ga] IIC/IIB T4 Gc
IECEX dust certificate	IECEX PTB 08.0057X
IECEX dust explosion protection	[Ex ia Da] IIIC
ATEX gas certificate	PTB 01 ATEX 2053 X
ATEX gas explosion protection	⊕ II 3 (1) G Ex nA [ia Ga] IIC/IIB T4 Gc
ATEX dust certificate	PTB 01 ATEX 2053 X
ATEX dust explosion protection	⊕ II (1) D [Ex ia Da] IIIC
Certificate FMus	3010778
Marking FMus	NONINCENDIVE FOR, Class I, Div. 2, Groups A,B,C,D; T4, Class I, Zone 2, Group IIC T4 IS connections for Class I,II,III, Div. 1, Groups A,B,C,D,E,F,G; Class I, Zone 0, Groups IIC/IIB Hazardous location when inst. per doc. 90 026 11 31 1
Certificate ULus	E81680V1S3
Marking ULus	For use in Hazardous location, Class I, Div. 2, Groups A,B,C,D; T4 Providing IS circuits for Class I,II,III, GROUPS A,B,C,D,E,F,G; per doc. 90 026 11 31 3
Certificate cCSA	1284580

9002/13-280-110-001 Art. No. 158857

Explosion Protection

Marking cCSA	Associated equipment [Ex ia], Class I, Div. 2, Groups A,B,C,D; Provides IS circuits for Class I,II,III, Class I, Zone 0, Groups IIC/IIB For applicable grps per inst. doc. 90 016 11 31 2
EAC certificate	TS RU C-DE.ГБ04.B.00651
EAC gas explosion protection	Ex 2 Ex nA [ia Ga] IIC T4 Gc X
EAC dust explosion protection	Ex [Ex ia Da] IIC
Inmetro gas certificate	UL-BR 12.0354
Inmetro dust certificate	UL-BR 12.0354
Certificates	ATEX (PTB), Brazil (ULB), Canada (CSA), China (CQST), EAC (STV), IECEx (PTB), India (PESO), Japan (CML), Korea (KGS), USA (FM), USA (UL)
Installation	in Zone 2, Division 2 and in safe area
Further information	see respective certificate and operating instructions

Safety Data

Max. voltage U_o/V_{oc}	28 V
Max. current I_o/I_{sc}	107 mA
Max. power P_o	749 mW
Max. permissible external capacitance C_o/C_a for IIC	0.083 μ F
Max. permissible external capacitance C_o/C_a for IIB	0.65 μ F
Max. permissible external inductance L_o/L_a for IIC	1.35 mH
Max. permissible external inductance L_o/L_a for IIB	9.6 mH

Electrical Data

Number of channels	2					
Rated operational voltage DC	24 V					
Maximum resistance R_{max}	296 Ω					
Min. resistance R_{min}	270 Ω					
Maximum output current I_{max}	82 mA					
Potential	Positive potential with diode feedback					
Potential Ch 1	Positive potential					
Potential Ch 2	Evaluation barrier +potential					
Resistive current limitation using frequency ≥ 50 mA	≤ 100 kHz					
Resistive current limitation using frequency ≤ 50 mA	≤ 50 kHz					
Leakage current I_{leck} for U_N	≤ 2 μ A					
Leakage current I_{leck} for $U_N 2$	(Unless specified otherwise)					
Channel	V_{nom}	R_{min}	R_{max}	U_o/V_{oc}	I_o/I_{sc}	P_o
1	24.00 V	270.00 Ω	296.00 Ω	28.00 V	107.0 mA	749.000 mW
2	24.00 V			28.00 V	3.0 mA	21.000 mW
1 + 2				28.00 V	110.0 mA	770.000 mW

Auxiliary Power

Nominal voltage V_{nom}	24 V
---------------------------	------

9002/13-280-110-001 Art. No. 158857

Auxiliary Power

Power supply	Controlled, nominal voltage
--------------	-----------------------------

Ambient Conditions

Ambient temperature °C	-20 °C ... +60 °C
Ambient temperature °F	-4°F ... +140°F
Storage temperature °C	-20 °C ... +75 °C
Storage temperature °F	-4°F ... +167°F
Max. relative humidity	95% on average, no condensation
Temperature influence	≤ 0,25 %/10K

Mechanical Data

Degree of protection (IP)	IP40
Terminal degree of protection (IP)	IP20
Enclosure material	Polyamide 6GF
Number of connection terminals	4
Connection cross section max.	1.5 mm ²
Connection cross-section AWG	... 16 AWG
Type of connection cable	Finely stranded Solid
Width	103 mm
Width inches	4.09 in
Length	12 mm
Length inches	0.48 in
Mounting depth	72 mm
Mounting depth inches	2.76 in
Weight	0.11 kg
Weight	0.24 lb

Mounting / Installation

Connection cross-section ground	4 mm ²
Cross-section ground AWG	12 AWG
Connection type	2 PA
Min. torque Nm	0.5 Nm
Min. torque lb / in	4.43 lb / in
Max. torque Nm	0.6 Nm
Max. torque lb / in	5.31 lb / in

Technical Drawings – Subject to Alterations

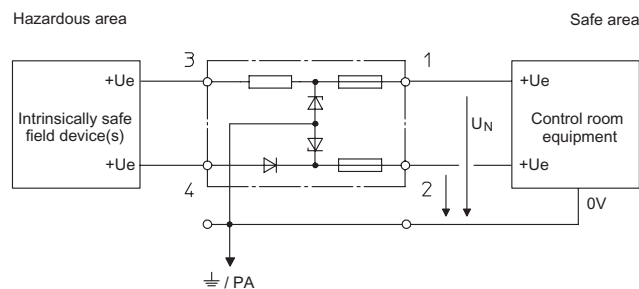

Two-channel safety barriers, safety barrier potential: + / evaluation barrier potential: +

Zener Barriers

Dual-channel safety barrier



9002/13-280-110-001 Art. No. 158857

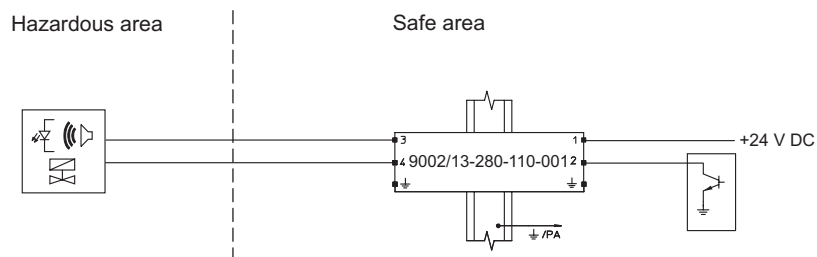

Application: Discrete 2-wire output for solenoid valves, LEDs and signalling devices

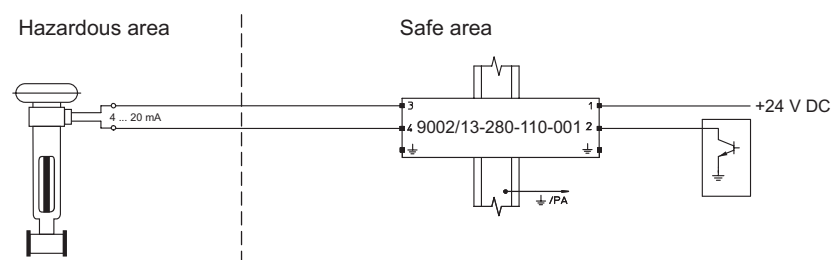

Application: 2-wire 4/20 mA I/P converters and control valves - standard and HART, 4/20 mA indicators

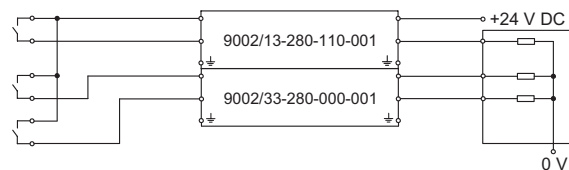

Application: Combination of potential-free contacts

Dimensional Drawings (All Dimensions in mm [inches]) – Subject to Alterations

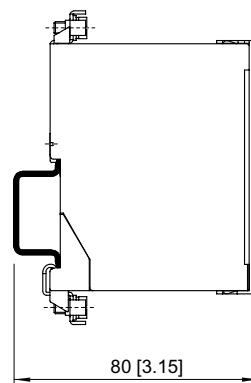
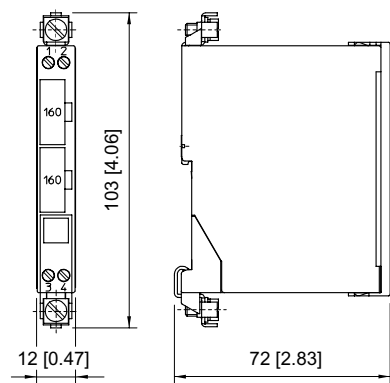

Mounting on DIN rail NS 35/15

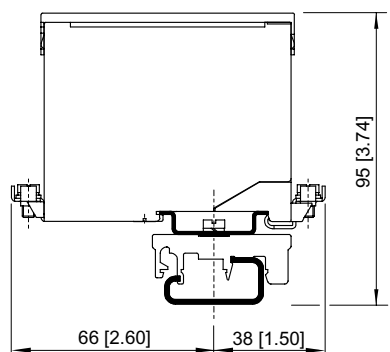

Mounting on DIN rail NS 32 by means of adaptor and mounting attachment, moulded plastic

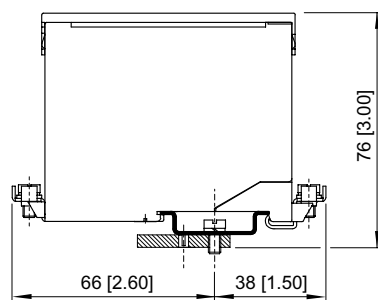

Mounting on mounting plate by means of adaptor

9002/13-280-110-001 Art. No. 158857

Accessories and Spare Parts

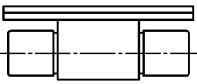
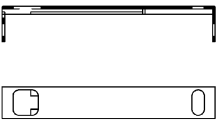
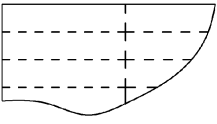
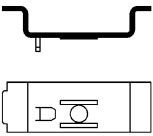
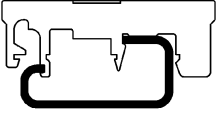
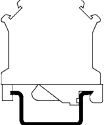
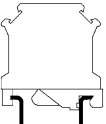
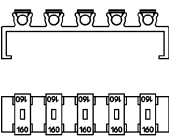
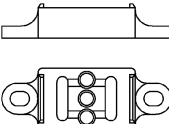
		Art. No.
Back-up fuse		
	For all zener barriers Series 9001, 9002 and 9004 unit: 5 pcs.	158964
Holder for label		Art. No.
	Transparent cover for labelling	158977
Labelling paper		Art. No.
	Perforated, for typing Format: DIN A4 Packaging unit: 80 pieces	158973
Adaptor		Art. No.
	Adaptor allows installation of a zener barrier Series 900x on a mounting plate of a previous series.	158826
Mounting attachment moulded plastic		Art. No.
	Enables mounting of zener barrier on a G-rail.	165283
Protective conductor terminal		Art. No.
	USLKG 5 (wire range AWG 12 / 4 mm ²) Terminal enables connection of protective conductors to DIN rail. Color green-yellow.	112760
Ground terminal		Art. No.
	USLKG 6 N (wire range AWG 10 / 6 mm ²) Terminal enables connection of protective /Ground conductors to DIN rail. Color green-yellow.	112599
Fuse holder		Art. No.
	Fuse holder is snapped onto the side of the zener barrier and can be equipped with up to 5 back-up fuses (replacement).	158834
Insulating stand off		Art. No.
	Suitable for DIN rail NS35/15, allows electrically insulated mounting of DIN rail from mounting plate.	158828

Zener Barriers

Dual-channel safety barrier



9002/13-280-110-001 Art. No. 158857

We reserve the right to make alterations to the technical data, dimensions, weights, designs and products available without notice. The illustrations cannot be considered binding.