

CUTTER MODULE OPERATION INSTRUCTIONS

© Panduit Corp. 2012

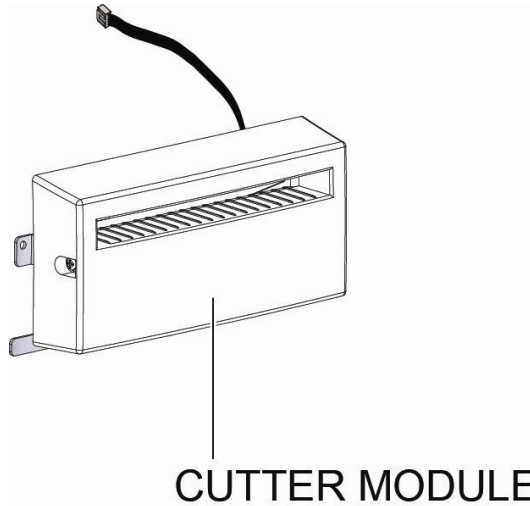

TO REDUCE THE RISK OF INJURY, USER
MUST READ INSTRUCTION MANUAL

Website: www.panduit.com
Email: id-support@panduit.com

EU Website:
www.panduit.com/emea

EU Email:
emeatoolservicecenter@panduit.com

PANDUIT

Technical Support:
Panduit Corp. • ID Products Division
Cumming, GA
Tel: 800-777-3300 • Fax: 708-532-1811

Panduit Europe • EMEA Service Center
Almelo, Netherlands
Tel: +31-546-580-452 • Fax: +31-546-580-441

Panduit Europe • West World Headquarters
Westgate, London
England Tel: 208-601-7200 • Fax: 208-601-7319



TABLE OF CONTENTS

| | |
|---|----------|
| INSTALLING A GUILLOTINE CUTTER MODULE ON THE TDP43ME PRINTER:..... | 1 |
| STEP 1. INSTALLING THE CUTTER MODULE ON THE PRINTER | 1 |
| | |
| FOR XP INSTALLATIONS:..... | 1 |
| STEP 1. SETTING THE CUTTER CUSTOM COMMAND | 1 |
| STEP 2. SETTING THE CUTTER TO USE EASY MARK ON XP INSTALLATIONS..... | 3 |
| | |
| FOR WINDOWS7 INSTALLATIONS:..... | 5 |
| STEP 1. SENDING THE CUTTER CUSTOM COMMAND | 5 |
| STEP 2. SETTING THE CUTTER FOR EASY MARK USE ON WINDOWS7 | |
| APPLICATIONS:..... | 8 |



INSTALLING A GUILLOTINE CUTTER MODULE ON THE TDP43ME PRINTER:

STEP 1. INSTALLING THE CUTTER MODULE ON THE PRINTER

Follow the instructions included in the Cutter Module box to physically install the Cutter module on the front of the printer housing for any Operating System Installation. (XP, Vista, Windows7).

NOTE: If the Printer Firmware version is "TDP43ME G3.0w6" or older, the following Custom Command must be entered into the Printer Driver. If the Firmware version is newer (higher) than this version, this "STEP 1, Setting the Cutter Custom Command", does not need to be done, it is contained within the Firmware. In this case, go directly to STEP 2. The top line of the Configuration Label indicates the Printer Firmware Version.

The following steps will guide the installer in changing the cutter settings for correct cutter location on Firmware versions TDP43ME G3.0w6 or older.

FOR XP INSTALLATIONS:

STEP 1. SETTING THE CUTTER CUSTOM COMMAND

The following steps will guide the installer in changing the cutter settings for correct cutter location on Firmware versions TDP43ME G3.0w6 or older.

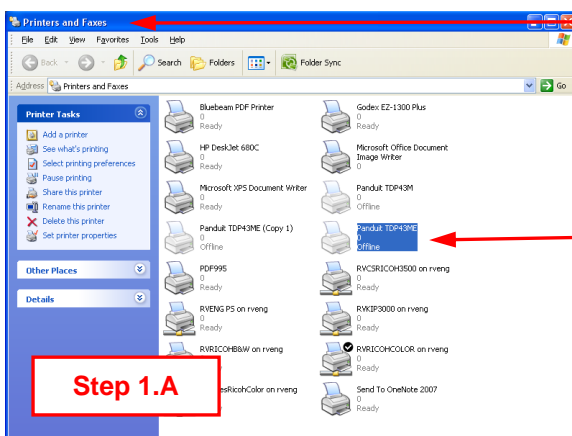

In START Menu, click on PRINTERS AND FAXES.

Highlight the printer to be controlled by this computer and right click.

Click on the PRINTING PREFERENCES line.

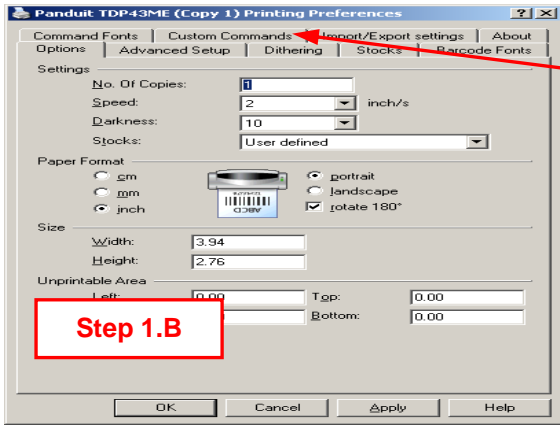

In the **PRINTING PREFERENCES** window, click on the **CUSTOM COMMANDS**

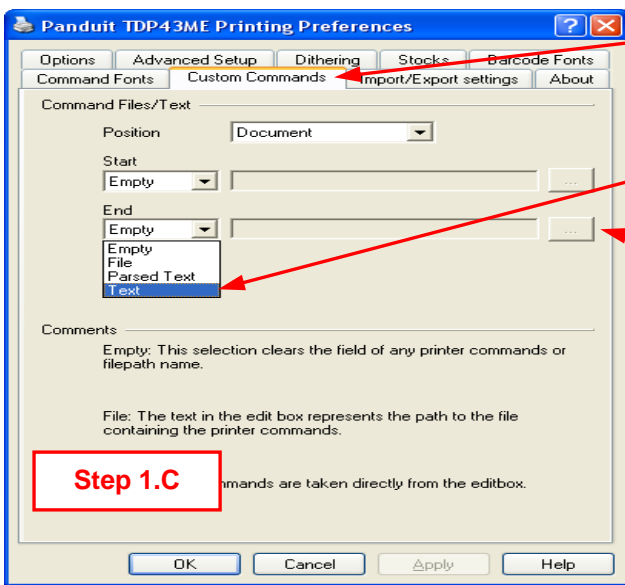

In the **CUSTOM COMMANDS** window, click on the **END** down arrow and drag the mouse down to **TEXT** and release.

Click on the ellipsis (three dots) button, the following window will pop up.

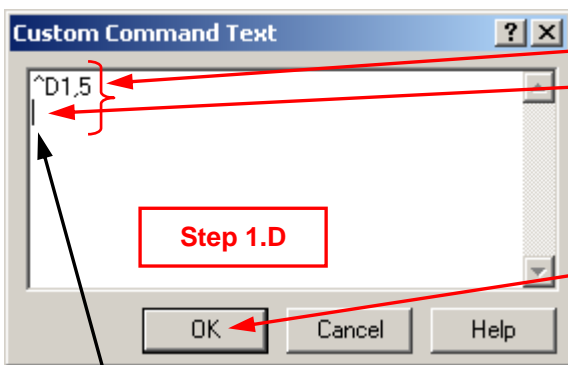

In this window, type “**^D1,5**” followed by a **RETURN**. Type it exactly like this command, with **UPPERCASE** letters, no spaces, no quotation marks, etc. (“**^**” is the Shift 6 button).

After the **RETURN** key, click **OK**. This action sets the printer to this setting once the next print job has been sent.

RETURN, very important!

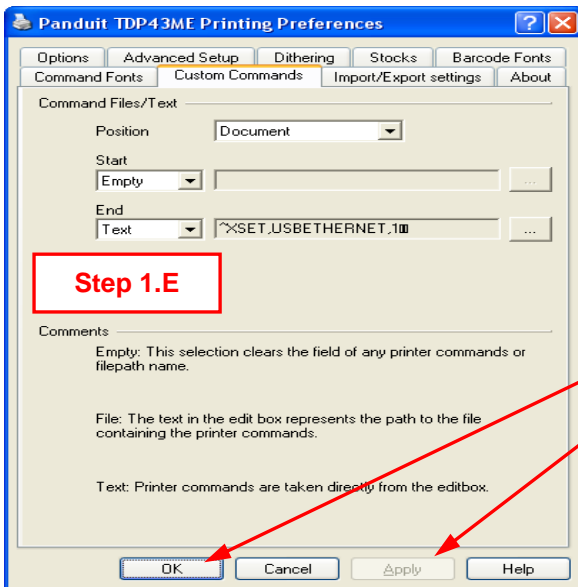

Click APPLY and then OK; and this window will disappear.

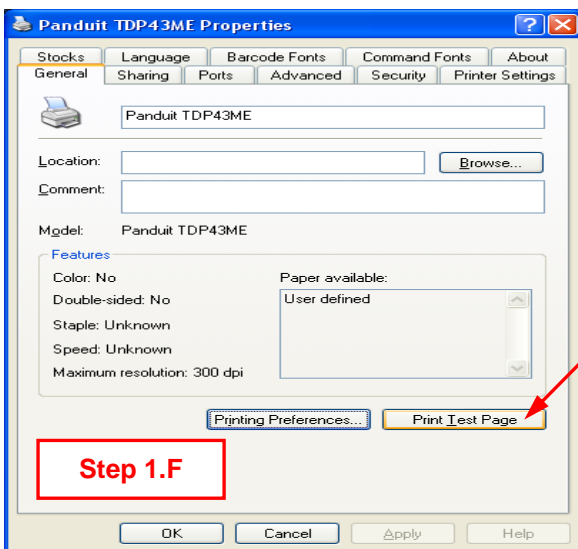

Turn the printer on. The printer must now print something for the Custom Command to take effect.

In the PROPERTIES window, click on PRINT TEST PAGE. The printer will print the test page. If the printer flashes a RED light and/or sounds two Beep-Beep sounds, this is OK. Simply turn the printer OFF, and then back ON. The error will clear itself.

The printer is now ready to cut. The label software must now be changed to add this feature.

STEP 2. SETTING THE CUTTER TO USE EASY MARK ON XP INSTALLATIONS.

The following steps will instruct the user in the use of the TDP43ME Cutter module within the Easy Mark software program.

NOTE: *The distance between cuts should not be less than the depth of the cutter (1”). If this distance is less than 1”, the cut labels will not be ejected from the cutter module and can jam the cutter mechanism.*

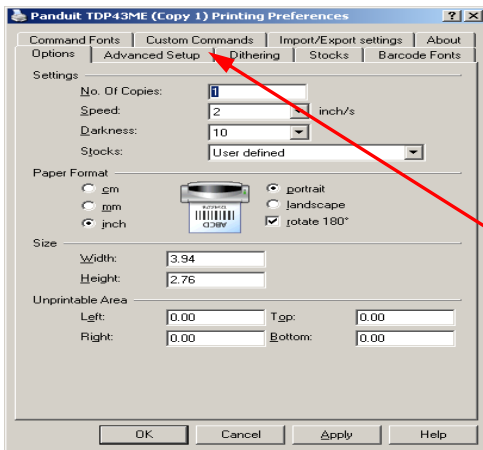

Click on the Windows Start Button in the lower left corner of the screen.

Click on PRINTERS and FAXES.

Right click on the printer driver with the cutter attached.

Drop down and click on the PRINTING PREFERENCES line.

Click on the ADVANCED SETUP tab.

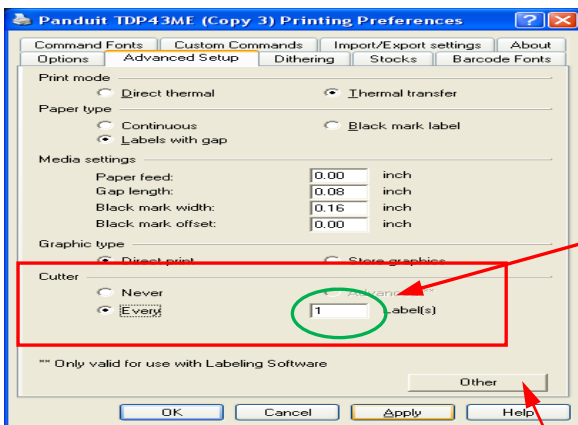

The bottom section of the pop-up window is for Cutter settings. The default setting is NEVER. Click next to the EVERY button. A whole number (*no fractions*) must be entered into the box next to LABELS. This number tells the cutter to cut after X number rows of printed labels. If this number is too small, the distance between cuts (cut length) will not be long enough to eject from the cutter module. The distance between cuts is set by the number placed in the box to the right. This whole number times the height of the label must be greater than 1".

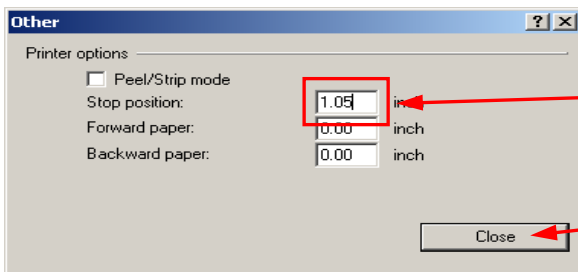

The STOP Position must be set. Click the OTHER button. Enter 1.05 into the STOP POSITION box. Click CLOSE. Click APPLY. Click OK. This closes PRINTING PREFERENCES window. The cutter is now ready for use.

FOR WINDOWS7 INSTALLATIONS:

STEP 1. SENDING THE CUTTER CUSTOM COMMAND

The following steps will guide the installer in changing the cutter settings for correct cutter location on Firmware versions TDP43ME G3.0w6 or older.

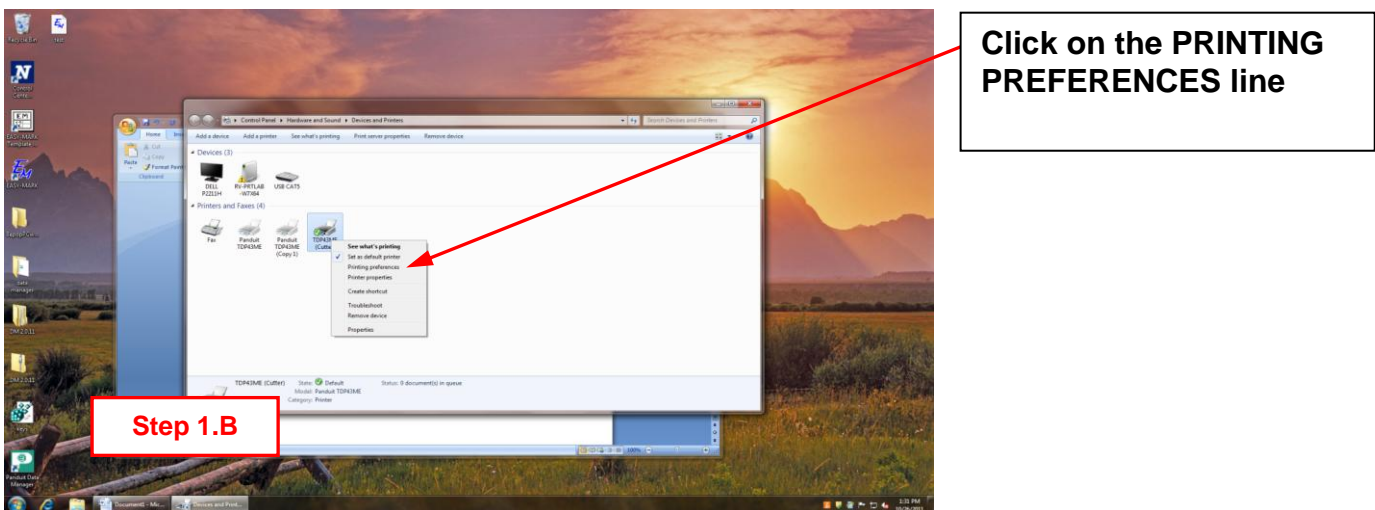
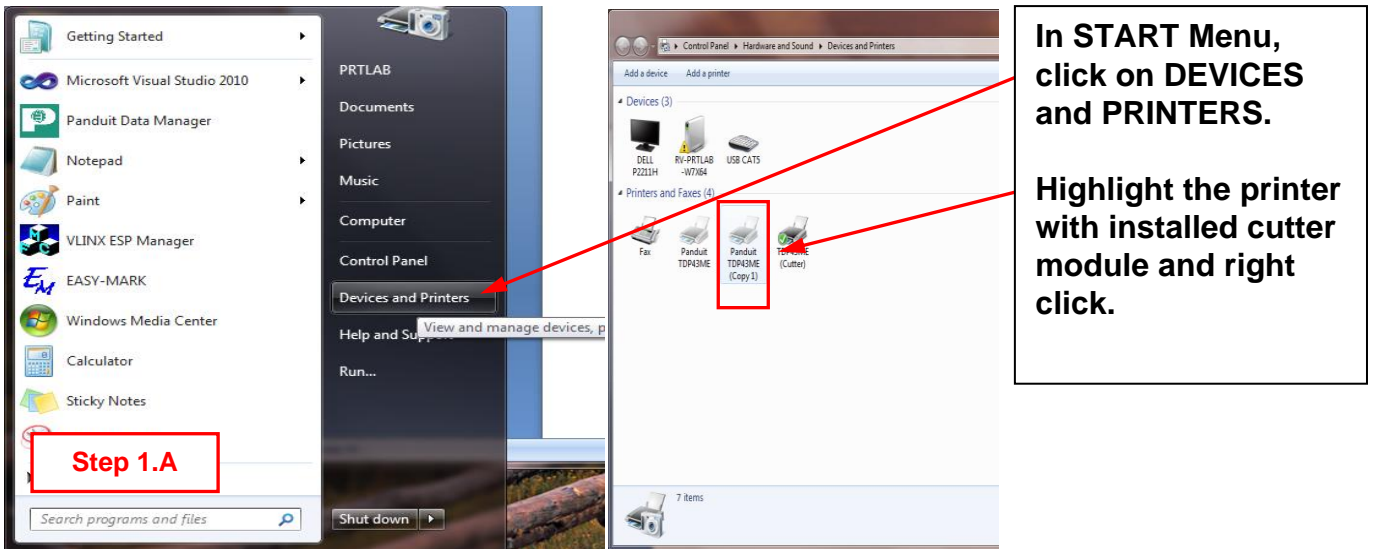

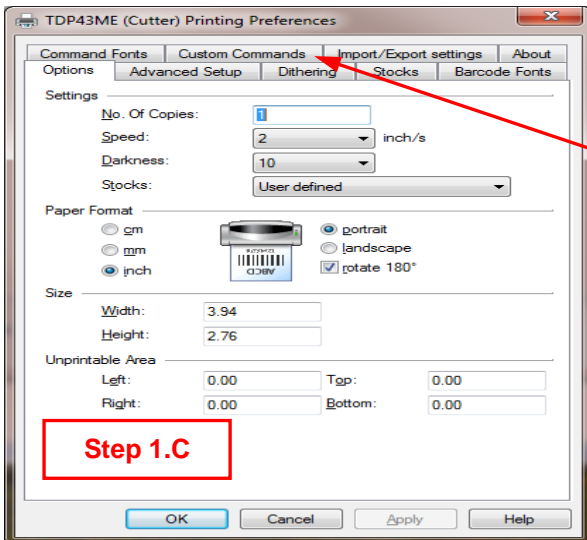

In the PRINTING PREFERENCES window, click on the CUSTOM COMMANDS tab.

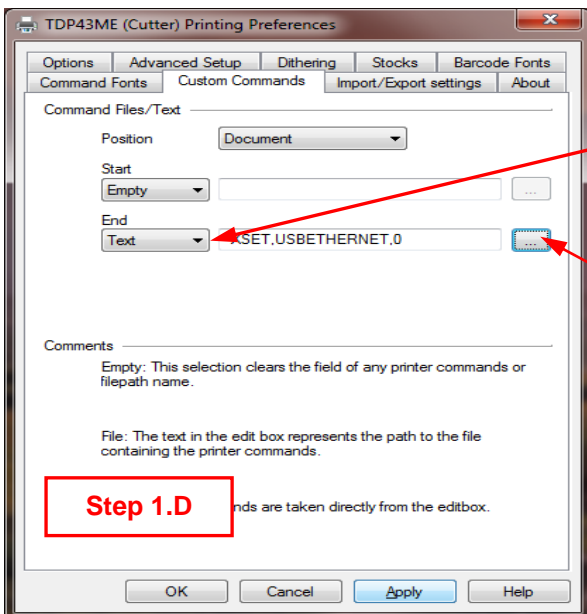

In the CUSTOM COMMANDS window, click on the END down arrow and drag the mouse down to TEXT and release.

Click on the ellipsis (three dots) button, the following window will pop up.

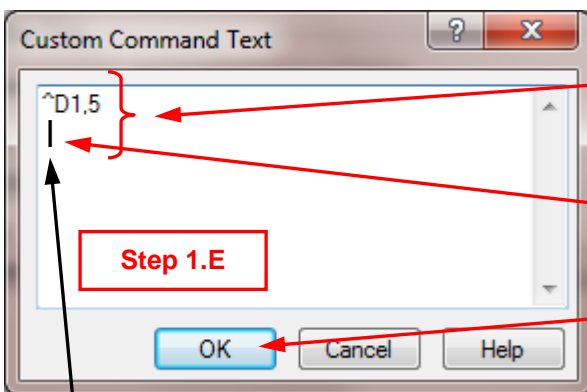

In this window, type “^D1,5” followed by a **RETURN**. Type it exactly like this command, with uppercase letters, no spaces, no quotation marks, etc. “^” is the Shift 6 button. After the RETURN key, click OK. This action sets the printer to this setting once the next print job has been sent.

RETURN, very important!

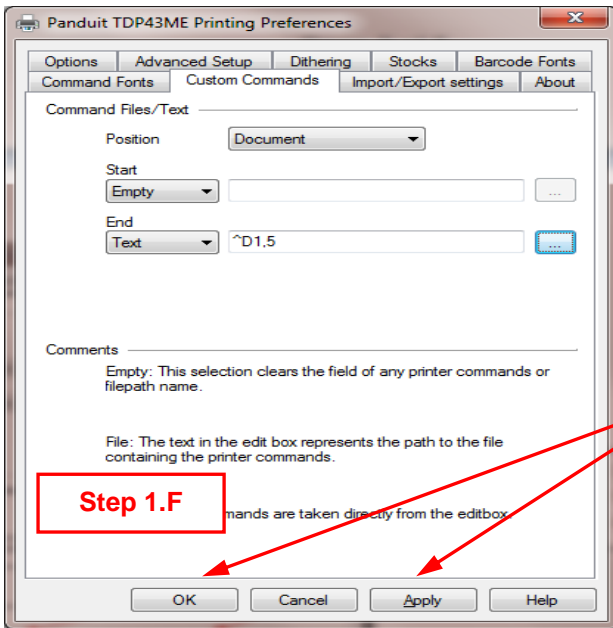

Click APPLY and then OK and this window will disappear.

The printer must now print something for the Custom Command to take effect.

In the Devices and Printers window, right click on the printer to be tested. Release the right mouse button on the PRINTER PROPERTIES line.

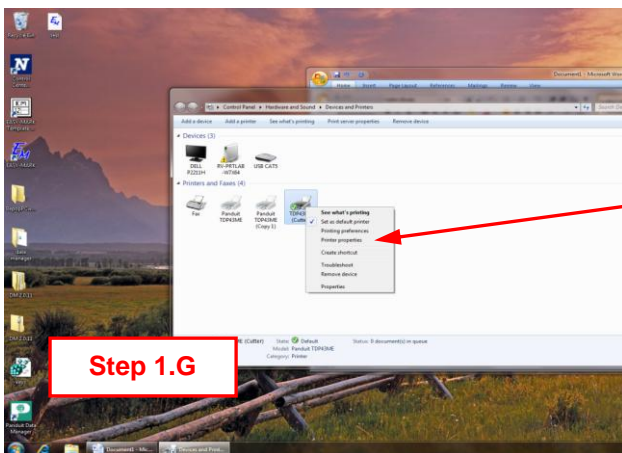

Turn the printer on. The printer must now print something for the Custom Command to take effect. In the PROPERTIES window, click on PRINT TEST PAGE. The printer will print the test page. If the printer flashes a RED light and/or sounds two Beep-Beep sounds, this is OK. Simply turn the printer OFF, and then back ON. The error will clear itself. The printer is now ready to cut. The label software must now be changed to add this feature.

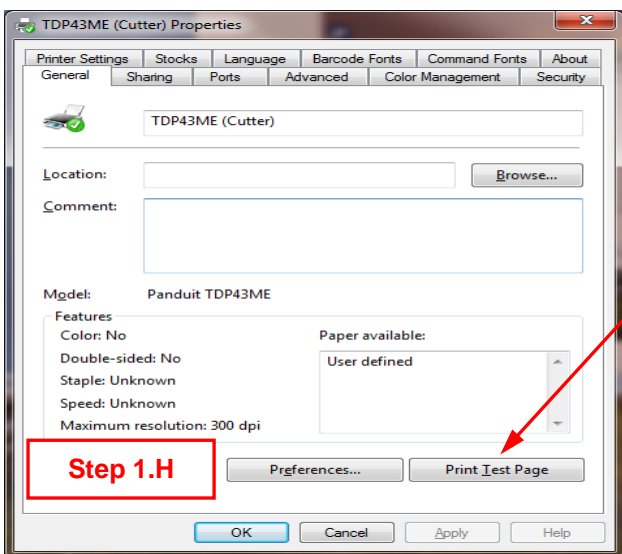

STEP 2. SETTING THE CUTTER FOR EASY MARK USE ON WINDOWS7 APPLICATIONS:

The following steps will instruct the user in the use of the TDP43ME Cutter module within the Easy Mark software program.

NOTE: The distance between cuts should not be less than the depth of the cutter (1"). If this distance is less than 1", the cut labels will not be ejected from the cutter module and can jam the cutter mechanism.

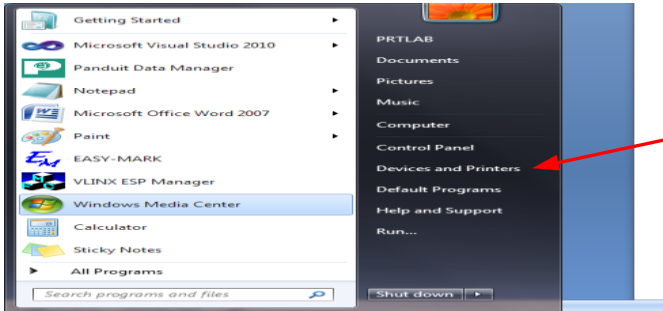

Click on the Windows Orb in the lower left corner of the screen. Click on **DEVICES and PRINTERS**. Right click on the printer with attached cutter module. Click on **PRINTER PREFERENCES**.

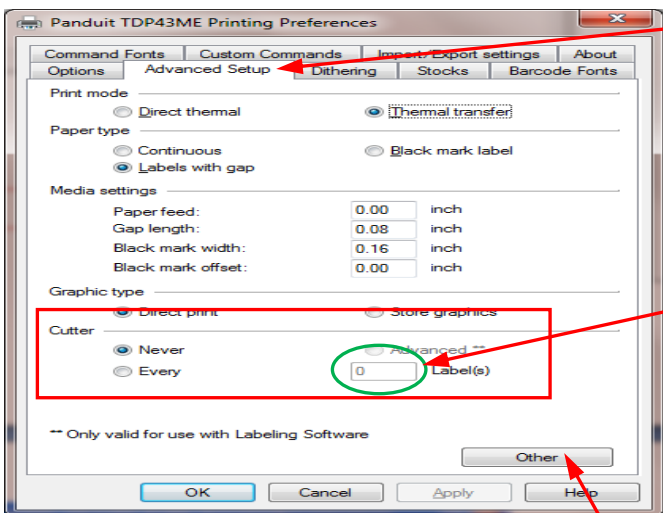

Click on the **ADVANCED SETUP** tab.

The bottom section of the pop-up window is for Cutter settings. The default setting is **NEVER**. Click next to the **EVERY** button. A whole number (*no fractions*) must be entered into the box next to **LABELS**. This number tells the cutter to cut after X number rows of printed labels. If this number is too small, the distance between cuts (cut length) will not be long enough to eject from the cutter module. The distance between cuts is set by the number placed in the box to the right. This whole number times the height of the label must be greater than 1".

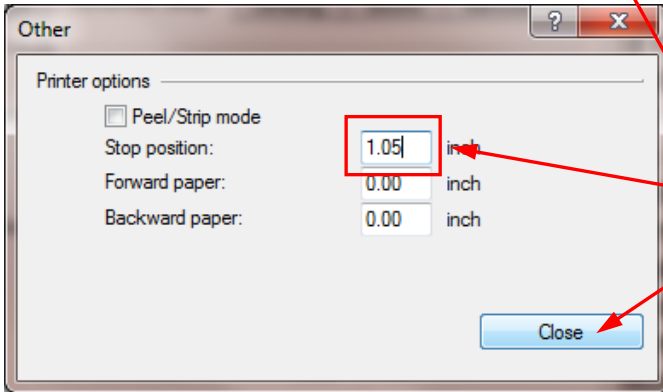

Click the **OTHER** button. Enter 1.05 into the **STOP POSITION** box. Click **CLOSE**. Click **APPLY**. Click **OK**. This closes **PRINTING PREFERENCES** window. Close **DEVICES and PRINTERS** window. The cutter is ready for use.