

8602C3-001-S Art. No. 223692



- Pushbutton, mushroom pushbutton, mushroom stay-put button with key lock, mushroom stay-put button, twin pushbutton and illuminated pushbutton, rotary actuator, key-operated switch, potentiometer bezel and indicator lamp bezel
- One axial actuator can actuate up to four 8082 series contact elements
- Key-operated switches and rotary switches codable at any time as "latching/spring return" or "key not removable"

WebCode **8602A**



Thanks to their special technical features, the actuators from the 8602/3 series can withstand the most extreme conditions. In addition to the application option for use in ambient temperatures from -60 °C to +70 °C, the IP degree of protection, IP66, is maintained in accordance with EN 60529. It is also possible to actuate up to four contact elements from the 8082 series with a single axial actuator from the 8602/3 series.

The coding option of the key switches and rotary switches is innovative and one-of-a-kind. Integrated coding allows you to adjust the "latching/spring return" and/or "key not removable" functions at any time without additional accessories. A versatile set of accessories consisting of label holders and locking devices is available.

## Technical Data

### Explosion Protection

Application range (zones)	1 2 21 22
IECEX gas certificate	IECEX PTB 13.0047U
IECEX gas explosion protection	Ex eb IIC Gb
IECEX dust certificate	IECEX PTB 13.0047 U
IECEX dust explosion protection	Ex tb IIIC Db
ATEX gas certificate	PTB 13 ATEX 1019 U
ATEX gas explosion protection	Ex II 2 G Ex eb IIC Gb
ATEX dust certificate	PTB 13 ATEX 1019 U
ATEX dust explosion protection	Ex II 2 D Ex tb IIIC Db
UL gas certificate	E182378 V4 S2
Inmetro gas certificate	UL-BR 14.0380U
Inmetro dust certificate	UL-BR 14.0380U
Certificates	ATEX (PTB), Brazil (ULB), Canada / USA (UL), EAC (CCVE), IECEX (PTB), India (PESO), Korea (KGS)

### Ambient Conditions

Ambient temperature	-60 °C ... +70 °C
Ambient temperature	-76 °F ... +158 °F
Storage temperature	-60 °C ... +70 °C
Storage temperature	-76 °F ... +158 °F
Use at the height of	< 2000 m

8602C3-001-S Art. No. 223692

### Ambient Conditions

Degree of contamination	3
-------------------------	---

### Mechanical Data

Degree of protection (IP)	IP66
Note on degree of protection	acc. to IEC/EN 60529
Enclosure material	Polyamide
Silicone-free	No
Assembly	001
Diameter	39 mm
Service life, min.	10 <sup>6</sup> actuations
Impact strength (IEC 60079)	7 J
Impact strength (IEC 62262)	min. IK08
Colour	black
Mounting	threaded version
Designation plate	black, blank label w/o text
Seal	Silicone
Packaging unit	1
Weight	0.034 kg
Weight	0.07 lb

### Mounting / Installation

Tightening torque	3 Nm
Tightening torque lbf in	1

### Technical Drawings – Subject to Alterations

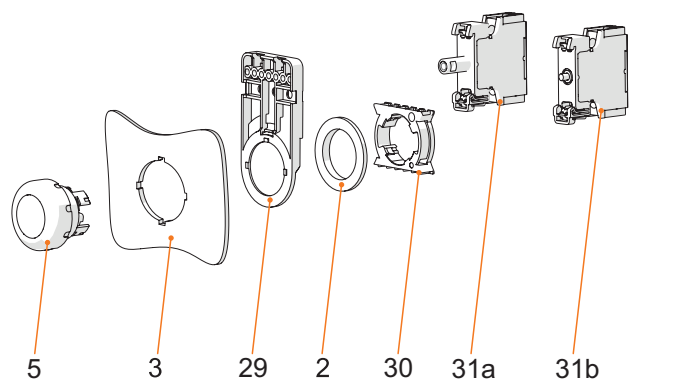

Front installation mounting with indication lamp series 8010/6 and contact element series 8082/3

#### Legend

- 2 = Jam nut (order no. 205592)
- 3 = Installation wall (wall thickness max. 5 mm [0.197 in])
- 5 = Actuator with seal
- 29 = Cable duct carrier (optional) (order no. 248673)
- 30 = Adaptor (order no. 227038)
- 31a = Built-in element: LED element 8010/6
- 31b = Built-in element: Contact element 8082/3

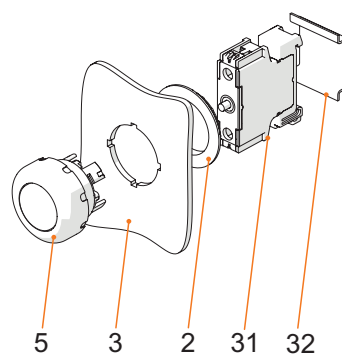

Mounting rail mounting

#### Legend

- 2 = Jam nut (order no. 205592)
- 3 = Installation wall (wall thickness max. 5 mm [0.197 in])
- 5 = Actuator with seal
- 31 = Built-in element
- 32 = Mounting rail TS35

8602C3-001-S Art. No. 223692

**Dimensional Drawings (All Dimensions in mm [inches]) – Subject to Alterations**

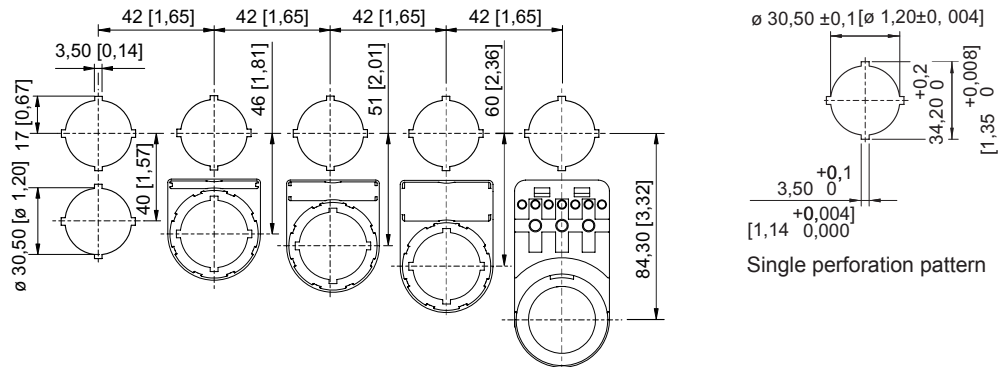



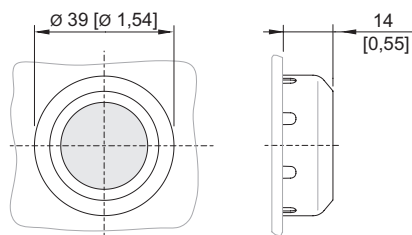







Standard cut-out with / without front label



8602/3-001 Pushbutton  
 Actuators with axial actuation









8602C3-001-S Art. No. 223692

### Accessories

Label holder		Art. No.
	Size 1, without insert disc, 1-line label for actuators Ø 39	223566
Insert discs for label holder		Art. No.
	1-line Plain Material: PVC Colour: White Self-adhesive	238271
	2-line Plain Material: PVC Colour: White Self-adhesive	238272
	3-line Plain Material: PVC Colour: White Self-adhesive	238273
Closing part		Art. No.
	8602C3-733-B for closing unused holes in cover, Ø 30.5 mm, NBR	244306
	8602C3-733-S for closing unused holes in cover, Ø 30.5 mm, silicone	244307
Designation plate for pushbutton and selector switch		Art. No.
	Blue Blank disc without text	215427
	Yellow Blank disc without text	215428
	Red Blank disc without text	215423
	Green Blank disc without text	215424
	White Blank disc without text	215426
	Black Blank disc without text	215425

8602C3-001-S Art. No. 223692

### Spare Parts

Locking devices		Art. No.
	8602C3-753 for not actuated pushbutton BG001	244870
	8602C3-754 for actuated pushbutton BG001	244871
	8602C3-755 for not actuated pushbutton BG001	244872
Label holder		Art. No.
	Size 2, without insert disc, 1- or 2-line label for actuators Ø 39	223567
	Size 3, without insert disc, 1-, 2- or 3-line label for actuators Ø 39	223568
Special key		Art. No.
	for tightening plastic locking nut	169101
Pressure plates		Art. No.
	Ø 37 mm 3 contact elements	215436
	Ø 48.5 mm 4 contact elements	215437
Holder for front installation		Art. No.
	8602/3 holder for cable duct	248673

8602C3-001-S Art. No. 223692

### Adaptor for front installation

Art. No.



8602/3 Front installation for indicator lamp series 8010/6 and contact element series 8082/3

227038

### 8082/3 Contact element

Art. No.



for NC contact front installation

240898

for NO contact front installation

240899

We reserve the right to make alterations to the technical data, dimensions, weights, designs and products available without notice. The illustrations cannot be considered binding.