

Cable gland

Without reduction sealing insert

8161/7-M20-1307 Art. No. 239172



- For safe cable entry in Ex e and Ex i areas
- Can be used at temperatures of between -60 ... +75 °C, degree of protection IP68
- Available in Ex e and Ex i versions (Ex i version distinguished by its blue cap nut)
- Suitable for cable diameters from 1 ... 48 mm
- Versions with multi-seal inserts

WebCode **8161B**



R. STAHL's 8161/7 and 8161/8 series cable entries can be used to safely run cables into Ex e enclosures. They are suitable for cables between 1 and 48 mm in diameter. They are available for Ex e and Ex i circuits – the Ex i version can be distinguished by its blue cap nut. An integrated stopping plug can be used to seal any cable entries that are not being used.

Technical Data

Explosion Protection

Ex version	Ex e
Application range (zones)	1 2 21 22
IECEX gas certificate	IECEX PTB 14.0011 X
IECEX gas explosion protection	Ex eb IIC Gb
IECEX dust certificate	IECEX PTB 14.0011 X
IECEX dust explosion protection	Ex tb IIIC Db
ATEX gas certificate	PTB 14 ATEX 1008 X
ATEX gas explosion protection	⊕ II 2 G Ex eb IIC Gb
ATEX dust certificate	PTB 14 ATEX 1008 X
ATEX dust explosion protection	⊕ II 2 D Ex tb IIIC Db
EAC certificate	TS RU S-DE.AA71.B.00083
EAC gas explosion protection	⊕ 1 Ex e II Gb X
EAC dust explosion protection	⊕ Ex tb IIIC Db X
Certificates	ATEX (PTB), Brazil (ULB), EAC (LPE), IECEX (PTB), Korea (KGS)

Ambient Conditions

Ambient temperature	-40 °C ... +75 °C
Use at the height of	< 2000 m

Mechanical Data

Degree of protection (IP)	IP66
Degree of protection note	IP68 at 5 bar 30 min. (IP protection according to IEC/EN 60529)
Sealing material	EPDM profile seal
Material sealing ring	EPDM
Material	Polyamide
Material 2	Glass fibre reinforced

Cable gland

Without reduction sealing insert

8161/7-M20-1307 Art. No. 239172

Mechanical Data

Silicone-free	Yes
Self-extinguishing	Yes
Flame retardant	Yes
Halogen-free	Yes
Surface resistance	$\leq 10^{13} \Omega$
Clamping range	7 – 13 mm
Clamping range max.	13 mm
Clamping range min.	7 mm
Armouring type	Unarmoured cable types
Dimension L	36 ... 43 mm
Dimension d1	27 mm
Dimension d2	13.3 mm
Dimension d4	13.3 mm
Width across corners	27 mm
Width across flats	24 mm
Thread size	M20
Thread length	10 mm
Thread pitch	1,5 mm
Impact strength (IEC 60079)	7 J
Impact strength	7 J
Colour	Black
Lot size	50
Weight	0.013 kg
Weight	0.03 lb

Dimensional Drawings (All Dimensions in mm [inches]) – Subject to Alterations

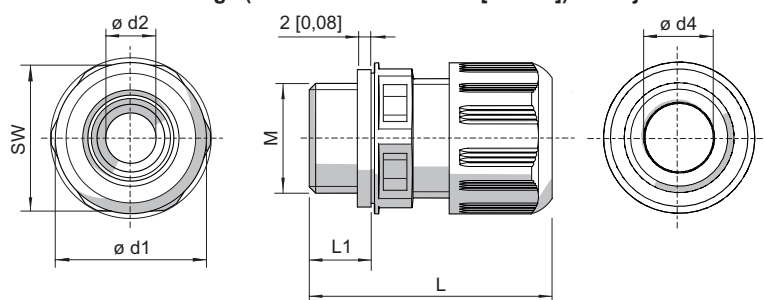

M = Thread size
 SW = Width across flats
 L1 = Thread length
 L = Dimension L

Cable glands without bend protection

Thread size	Width across flats	Dimension L	Dimension L (with long thread)	Thread length	Thread length (long thread)	Clamping range	Clamping range + reduction sealing insert	Dimension d1	Dimension d2	Dimension d4
M12	16,00 mm	29 ... 34 mm	35 ... 40 mm	9.000 mm	15.000 mm	3.00 - 6.00 mm	1.00 - 6.00 mm	18 mm	7.3 mm	6.3 mm

Installation Equipment and Accessories



Cable gland

Without reduction sealing insert

8161/7-M20-1307 Art. No. 239172

M16	20.00 mm	31 ... 37 mm	37 ... 43 mm	9.000 mm	15.000 mm	5.00 - 9.00 mm	2.00 - 9.00 mm	22 mm	10.3 mm	9.3 mm
M20	24.00 mm	36 ... 43 mm	41 ... 48 mm	10.000 mm	15.000 mm	7.00 - 13.00 mm	4.00 - 13.00 mm	27 mm	13.3 mm	13.3 mm
M25	29.00 mm	38 ... 46 mm	43 ... 51 mm	10.000 mm	15.000 mm	10.00 - 17.00 mm	7.00 - 17.00 mm	32 mm	17.3 mm	17.3 mm
M32	36.00 mm	42 ... 50 mm	45 ... 53 mm	12.000 mm	15.000 mm	13.00 - 21.00 mm	9.00 - 21.00 mm	40 mm	21.3 mm	21.3 mm
M40	46.00 mm	52 ... 65 mm	58 ... 71 mm	12.000 mm	18.000 mm	17.00 - 28.00 mm	12.00 - 28.00 mm	51 mm	28.3 mm	30 mm
M50	55.00 mm	59 ... 72 mm	63 ... 76 mm	14.000 mm	18.000 mm	23.00 - 35.00 mm	16.00 - 35.00 mm	61 mm	35.3 mm	40 mm
M63	68.00 mm	64 ... 78 mm	67 ... 81 mm	15.000 mm	18.000 mm	34.00 - 48.00 mm	28.00 - 48.00 mm	75 mm	48.3 mm	53 mm

Installation Equipment and Accessories



Cable gland

Without reduction sealing insert

8161/7-M20-1307 Art. No. 239172

Accessories

Locknut, brass nickel-plated (-60 ... +75 °C)

To fasten the cable glands in through holes

Art. No.



Material: Nickel-plated brass Lot size: 100
Thread size: M20

241520

Locknut, plastic (-40 ... +75 °C)

To fasten the cable glands in through holes

Art. No.



Material: Polyamide Lot size: 100
Thread size: M20

239462

Reduction sealing insert (standard), EPDM (-40 ... +75 °C)

For cable glands

Art. No.

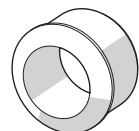

Connection thread: M20 x 1.5 Lot size: 50
Clamping range: 4 – 8 mm

239446

Reduction sealing insert, silicone (-60 ... +75 °C)

For low temperature

Art. No.

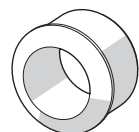

Connection thread: M20 x 1.5 Lot size: 50
Clamping range: 4 – 8 mm

239454

Special key

Art. No.

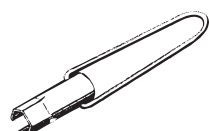

Thread size: M20 Packaging unit: 1

114208

Plug (-60 ... +75 °C)

For closing unused cable glands

Art. No.

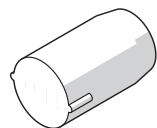

Thread size without reduction sealing insert: M16 Lot size: 50
Thread size with reduction sealing insert: M20
Diameter: 8 mm
Material: Polyamide

240048

Thread size without reduction sealing insert: M20 Lot size: 50
Thread size with reduction sealing insert: M25
Diameter: 12 mm
Material: Polyamide

240049

Spare Parts

Flat gasket (standard), EPDM (-40 ... +75 °C)

Replacement seals for cable glands

Art. No.

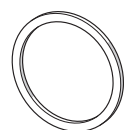

For cable glands 8161/-M20-13 Lot size: 100
Connection thread: M20

222371

For cable glands 8161/-M20-13 Lot size: 50
Connection thread: M20

222364

Installation Equipment and Accessories



Cable gland

Without reduction sealing insert

8161/7-M20-1307 Art. No. 239172

Flat gasket silicone (-60 ... +75°C)

Replacement seals for low temperature

Art. No.

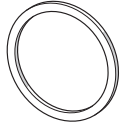

For cable glands 8161/-M20-13 Lot size: 100
Connection thread: M20

240249

We reserve the right to make alterations to the technical data, dimensions, weights, designs and products available without notice. The illustrations cannot be considered binding.