



- Flexible: Modular structure and 3 sizes enable customer-specific versions
- Lightweight enclosure made from glass fibre reinforced polyester resin (GRP), suitable for shipping industry and offshore
- Versions with contact elements 8082 and 8208, usable up to SIL 2 and/or SIL 3

WebCode **8040B**



With the R. STAHL Series 8040 control device system, you can get a clear overview of the control devices. The 3 combinable design sizes and the modular structure offer flexibility. You can choose from one standard version and customised variants. The 8208 contact elements monitor the systems for wire breakage and short circuit.

Technical Data

Explosion Protection

Scope of validity	IECEX European Union (ATEX)
Application range (zones)	1 2 21 22
IECEX gas certificate	IECEX PTB 06.0025
IECEX gas explosion protection	Ex db eb IIC T6/T5 Gb
IECEX dust certificate	IECEX PTB 06.0025
IECEX dust explosion protection	Ex tb IIIC T80 °C ... T95 °C Db
ATEX gas certificate	PTB 01 ATEX 1105
ATEX gas explosion protection	⊕ II 2 G Ex db eb IIC T6/T5 Gb
ATEX dust certificate	PTB 01 ATEX 1105
ATEX dust explosion protection	⊕ II 2 D Ex tb IIIC T80 °C ... T95 °C Db
EAC certificate	TS RU S-DE.AA71.B.00115
EAC gas explosion protection	⊕ 1 Ex d e IIC T6 Gb X
EAC dust explosion protection	⊕ Ex tb IIIC T80 °C Db X
Certificates	ATEX (PTB), Brazil (ULB), Canada (UL), China (NEPSI), EAC (LPE), IECEX (PTB), Korea (KGS), Taiwan (ITRI), USA (UL)
Ship approval	DNV GL
Notes	CCC certificate available from 2021 onward

Electrical Data

Rated operational voltage AC	690 V
Rated operational current	10 A (T6)

8040/1280X-54C06SA70-01L08SA05 Art. No. 130852

Ambient Conditions

Ambient temperature	-60 °C ... +40 °C (T6) -60 °C ... +55 °C (T5)
---------------------	--

Mechanical Data

Degree of protection (IP)	IP66
Degree of protection note	acc. to IEC/EN 60529
Enclosure material	Polyester resin, Glass fibre reinforced
Silicone-free	No
Connection cross section max.	2.5 mm ²
Cover fixing type	With captive screws, M4 stainless steel screws
Seal	Silicone, foamed
Weight	0.46 kg
Weight	1.01 lb

Components

Installation position top	Indicator lamp bezel All colours
Built-in element top	LED indicator lamp
Installation position bottom	Pushbutton Red - "0"
Built-in element bottom	Contact element NC / NO
Number of poles on bottom built-in element	2
Flange and plates	Without flange, without plates
Cable entries	1 x M25 Ø 7 to 17 mm
Entry type	Standard 8161, moulded material

8040/1280X-54C06SA70-01L08SA05 Art. No. 130852

Technical Drawings – Subject to Alterations

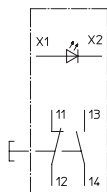

Dimensional Drawings (All Dimensions in mm [inches]) – Subject to Alterations

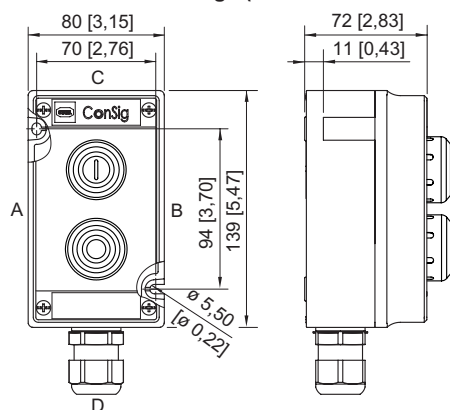

ConSig 8040/12

Accessories

Cylinder lock



for closing (bracket \varnothing 3)

Art. No.

107115

Spare key



Closing MS1

Art. No.

107109

Spare Parts

Caps for BG 054



for indicator lamp, all colours packaged

Art. No.

248685

8040/1280X-54C06SA70-01L08SA05 Art. No. 130852

Colour filter for BG 735

Art. No.

	for illuminated pushbutton, all colours packaged	248684
--	--	--------







Labelling paper

Art. No.

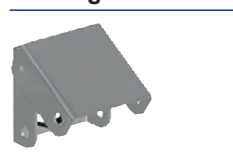
	Label (labelling via configurator)	270552
--	------------------------------------	--------



Locking devices

Art. No.

	8602C3-752 for actuated mushroom stay-put button BG010, BG012	244869
	8602C3-753 for not actuated pushbutton BG001	244870
	8602C3-754 for actuated pushbutton BG001	244871
	8602C3-755 for not actuated pushbutton BG001	244872
	8602C3-756 for actuated mushroom stay-put button BG010, BG012	244873
	8602C3-758 for not actuated mushroom stay-put button BG010, BG012	244874

Protective collar

Art. No.

	8602C3-751 plastic/red for mushroom stay-put button with key lock/mushroom stay-put button Ø 39 BG006, BG009, BG010, BG012	257707
	8602C3-751 plastic/yellow for mushroom stay-put button with key lock/mushroom stay-put button Ø 39 BG006, BG009, BG010, BG012	257708

Special key

Art. No.



	for tightening plastic locking nut	169101
--	------------------------------------	--------

Control Devices

Control device system ConSig 8040 series



8040/1280X-54C06SA70-01L08SA05 Art. No. 130852

Label holder		Art. No.
	Size 2, without insert disc, 1- or 2-line label for actuators Ø 39	223567
	Size 3, without insert disc, 1-, 2- or 3-line label for actuators Ø 39	223568

We reserve the right to make alterations to the technical data, dimensions, weights, designs and products available without notice. The illustrations cannot be considered binding.