

Remote I/O

Remote I/O IS1+ Digital output module

For Zone 1 Ex i

9475/32-08-52 Art. No. 210655



- Eight channels for Ex i solenoid valves up to 30 mA
- Ex ia outputs with line fault monitoring and LED error and status indication for each channel plus SIL 2 shutdown input
- Modules in Zone 1, Cl. I, II, Div. 1 can be hot swapped

WebCode 9475C



9475/32-08 series digital output modules for Zone 1, Cl. I, II, Div. 1 have eight channels for actuating Ex i solenoid valves or indicator lamps. An additional Ex i control input is suitable for safe shutdown up to SIL 2. All outputs are short-circuit proof, galvanically separated from the system and individually monitored to check for wire breakage/short-circuiting.

Technical Data

Explosion Protection

Application range (Zones)	1 2
Ex interface zone	0 1 2 20 21 22
IECEX gas certificate	IECEX DEK 12.0070X
IECEX gas explosion protection	Ex ia [ia Ga] IIC T4 Gb
IECEX dust certificate	IECEX DEK 12.0070X
IECEX dust explosion protection	[Ex ia Da] IIIC
ATEX gas certificate	DEKRA 12 ATEX0232X
ATEX gas explosion protection	⊕ II 2 (1) G Ex ia [ia Ga] IIC T4 Gb
ATEX dust certificate	DEKRA 12 ATEX0232X
ATEX dust explosion protection	⊕ II (1) D [Ex ia Da] IIIC
Certificate FMus	FM17US0332X
Certificate cFM	FM16CA0134X
Marking cFMus	IS, Class I, Div. 1, Groups A,B,C,D; Class I, Zone 1, AEx/Ex ia [ia] IIC AIS Class I,II,III, Div. 1, Groups A,B,C,D,E,F,G; T4 at Ta = 75°C See Doc. 9475 6 031 002 1
EAC certificate	TS RU S-DE.GB04.B.00448
EAC gas explosion protection	⊕ 1 Ex ia [ia Ga] IIC T4 Gb X
EAC dust explosion protection	⊕ [Ex ia Da] IIIC
Certificates	ATEX (DEK), Brazil (ULB), Canada (FM), EAC (ENDCE), IECEX (DEK), India (PESO), Korea (KTL), SIL (exida), USA (FM)

Remote I/O

Remote I/O IS1+ Digital output module

For Zone 1 Ex i

9475/32-08-52 Art. No. 210655



Explosion Protection

Ship approval	EU RO MR
Notes	CCC certificate available from 2021 onward
Installation	Zone 1, Zone 2, Cl. I, Div. 1, 2 and in the safe area
Further information	see respective certificate and operating instructions

Safety Data

Max. voltage U_o/V_{oc}	19.4 V
Max. current I_o (Ex ia)	143 mA
Max. power P_o (Ex ia)	692 mW
Max. current I_o (Ex ib)	37.8 mA
Max. power P_o (Ex ib)	506 mW
Internal inductance L_i	Negligible
Max. internal capacity C_i	5,2 nF (in the above tables, C_i is subtracted from C_o)

Max. connectable inductance L_o / capacity C_o								
Output ia								
IIC	L_o [mH]	1.44	1.4	0.65	0,5	0.2	0.1	0.05
	C_o [nF]	--	103	113	113	153	183	227
IIB / IIIC	L_o [mH]	7.5	5.0	2.0	0.5	0.2	0.1	0.02
	C_o [nF]	673	883	943	943	1083	1283	1493
Output ib								
IIC	L_o [mH]	6.3	2.0	0.65	0.5	0.2	0.1	0.05
	C_o [nF]	113	113	123	123	153	193	227
IIB / IIIC	L_o [mH]	58	20	10	5.0	0.2	0.1	0.02
	C_o [nF]	363	723	953	963	1083	1283	1493

Ex i control input "Pant STOP"								
Connection terminals		X3 1, 2 (without galvanic separation, 9475/22 compatible)					X3 3, 4 (with galvanic separation, switchable in parallel)	
Type of protection		Ex ia					Ex ia	
Max. voltage U_o		5.1 V					--	
Max. current I_o		0.44 mA					--	
Max. power P_o		0.5 mW					--	
Max. connectable inductance L_o / capacity C_o								
IIC	L_o [mH]	100	10	2	1	0.2	0.01	--
	C_o [nF]	2.195	2.595	3.295	3.695	5.495	15.995	
IIB / IIIC	L_o [mH]	100	10	2	1	0.2	0.01	--
	C_o [nF]	9.995	12.995	16.995	19.995	31.995		
Max. voltage U_i		--					30 V	
Max. internal resistance R_i		--					4940 Ω	

Electrical Data

Number of channels	8 Ex i outputs
--------------------	----------------

Remote I/O

Remote I/O IS1+ Digital output module

For Zone 1 Ex i

9475/32-08-52 Art. No. 210655



Electrical Data

Connection Ex i field signals	Pluggable, blue terminals, 16-pin, 2.5 mm ² , screw or cage clamp version with lock		
Connection Ex i Steuereingang	Pluggable, blue terminals, 2-pin, 2.5 mm ² , screw type version with lock		
Ex i control input X3 Connection terminals		X3 1, 2 (without galvanic separation, 9475/22 compatible)	X3 3, 4 (with galvanic separation, switchable in parallel)
	Supply voltage	3.3 V	--
	Internal resistance	20.5 kΩ	--
	Control voltage for all outputs "OFF" ("Plant STOP" activated)	> 2.2 V	< 1 V
	"Normal operation" ("Plant STOP" deactivated)	< 0.7 V	> 6 V

Auxiliary Power

Power supply connection	BusRail types 9494
Auxiliary power version	Intrinsically safe Ex ia via BusRail
Behaviour during undervoltage	All outputs "OFF"
Current consumption	250 mA
Max. power consumption	6 W
Max. power dissipation outputs	4.8 W
Max. power dissipation rated operation	0 W

Galvanic Isolation

Test voltage for galvanic isolation	According to standard EN 60079-11
Auxiliary power/system components	≥ 1500 V AC
I/O module / I/O module	≥ 500 V AC
I/O channels/system components	≥ 500 V AC
I/O channels / ground (PA)	≥ 500 V AC
I/O channels/plant STOP X3 3.4	≥ 500 V AC
Plant STOP X3 3.4 / earth (PA)	≥ 500 V AC

Input

Control input	Ex i control input X3
Control input suitability	Switch-off up to SIL 2, low demand (IEC61508)
Control input function	"Plant STOP" to switch off all outputs

Output

Ex i output rated operation	12.6 V/30 mA
Internal resistance of outputs	170 Ω
Open-circuit voltage U _a	17.5 V
Output characteristic 9475/33-08-50	<p>The graph shows the output voltage U_a in Volts on the y-axis (ranging from 0 to 25) against the current I in mA on the x-axis (ranging from 0 to 35). A solid blue line starts at (0, 17.5) and slopes downwards to (30, 12.6). At 30 mA, the voltage drops vertically to 0 V, indicating the maximum current rating.</p>

Device Specific Data

Diagnostics message module	OFF ON
----------------------------	-----------

Remote I/O

Remote I/O IS1+ Digital output module

For Zone 1 Ex i

9475/32-08-52 Art. No. 210655



Device Specific Data

Line fault monitoring	ON without test current OFF ON
Test current signal	0,2 ... 0,28 mA
Output behaviour in case of error	Keep last value ON OFF
LED module requires maintenance	"M/S" LED, blue
LED operating conditions	"RUN" LED, green
LED group error	"ERR" LED, red
LED channel error	LED for each channel, red
LED channel status	LED per channel, yellow
"Plant STOP" LED	(all outputs are high-impedance) "Plant STOP" LED, yellow
Retrievable parameters	Hardware revision Manufacturer Serial number Software revision Type
Signal status bit	"1" = Output supplied with power "0" = High-impedance output
Wire breakage output	> 12 k Ω (with deactivated test current can be detected only if the output is switched on)
Short circuit output	< 30 Ω (response range 30 ... 60 Ω) (can be detected only if the output is switched on)

Ambient Conditions

Ambient temperature °C	-40°C ... +75°C
Ambient temperature °F	-40°F ... +167°F
Storage temperature °C	-40°C ... +80°C
Storage temperature °F	-40°F ... +176°F
Max. operating altitude	< 2000 m
Max. relative humidity	95% (without condensation)
Shock (semi-sinusoidal)	(IEC EN 60068-2-27) 15 g (3 shocks per axis and direction)
Vibration (sinusoidal)	(IEC EN 60068-2-6) Frequency range 2 ... 13.2 Hz Amplitude 1 mm (peak value) Frequency range 13.2 ... 100 Hz Acceleration amplitude 0.7 g
Electromagnetic compatibility	Tested to the following standards and regulations: EN 61326-1 (2006) IEC 61000-4-1 to 61000-4-6, NAMUR NE 21
Note	(observe operating instructions)

Mechanical Data

Degree of protection IP (IEC 60529)	IP20
Module enclosure	Polyamide 6GF
Fire resistance (UL 94)	V2
Pollutant class	Corresponds to G3
Width	96.5 mm
Width inches	3.8 in
Height	67 mm
Length	128 mm

Remote I/O

Remote I/O IS1+ Digital output module

For Zone 1 Ex i

9475/32-08-52 Art. No. 210655



Mechanical Data

Length inches	5.04 in
Mounting depth inches	2.64 in
Weight	0.275 kg
Weight	0.61 lb

Mounting / Installation

Mounting type	on DIN rail NS 35/15 (DIN EN 60715)
Mounting position	Horizontal Vertical

Technical Drawings – Subject to Alterations

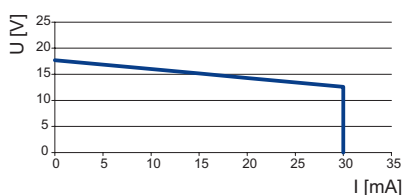

Output characteristic 9475/33-08-50

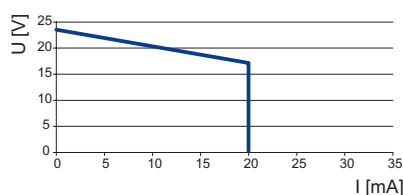

Output characteristic 9475/33-08-60

Dimensional Drawings (All Dimensions in mm [inches]) – Subject to Alterations

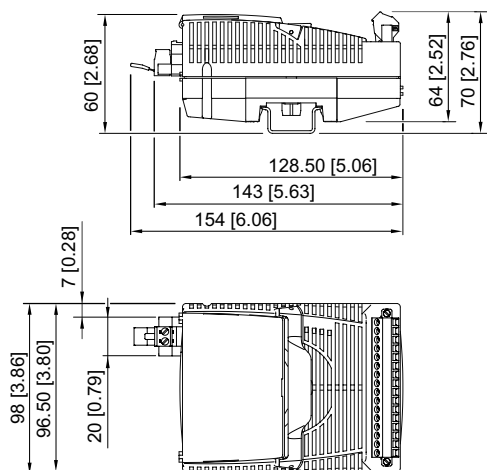

Remote I/O







Remote I/O IS1+ Digital output module

For Zone 1 Ex i

9475/32-08-52 Art. No. 210655

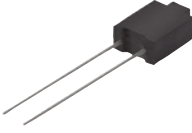

Accessories

Pluggable terminal		Art. No.
	2.5 mm ² with lock, 16-pole, screw connector, blue, for connecting the field signals to I/O modules, for intrinsically safe field circuits Labelling: 1 ... 16 Attention: An additional terminal is necessary for I/O module Series 9470 and 9482. Labelling: 17 ... 32	162702
	2.5 mm ² with lock, 16-pole, spring clamp connection, blue, for connecting the field signals to I/O modules, for intrinsically safe field circuits, incl. test jacks Labelling: 1 ... 16 Attention: An additional terminal is necessary for I/O module Series 9470 and 9482. Labelling: 17 ... 32	162695
Electronic relay		Art. No.
	The electronic relay module 9174 is used to switch Ex e loads by using intrinsically safe control signals. Input: Ex i Output: 48 V / 2 A DC, Ex e	212340
	The electronic relay modules are used to switch from Ex e loads via intrinsically safe (Ex i) or non-intrinsically safe (Ex e) control. Coil circuit: Ex i or non-Ex i (Ex e)* Contact circuit: Non-Ex i (Ex e) *You can switch between Ex i and non-Ex i circuits, or vice-versa, at any time without restriction.	282457
Ex i/Ex e relay module for Zone 1		Art. No.
	The Ex i/Ex e relay modules are used for the galvanically isolated switching of intrinsically safe circuits (Ex i) and non-Ex i (Ex e) electrical circuits. Coil circuit: Ex i or non-Ex i (Ex e)* Contact circuit: Ex i or non-Ex i (Ex e)* *You can switch between Ex i and non-Ex i circuits, or vice-versa, at any time without restriction	273000
Partition		Art. No.
	For mounting between intrinsically safe and non-intrinsically safe connections of the I/O modules, in order to adhere to the required 50 mm distance	220101
Resistor error message suppression		Art. No.
	The resistors are used to suppress error messages for unused I/O channels Resistance value: 5K6 / 0.5 W Suitable for: AIM 9468; UMH 9469; DIOM 9470; DIOM 9471; DIOM 9472; DOM 9475 For intrinsically safe circuits (simple apparatus according to EN 60079-11)	244911

Spare Parts

Warning sign		Art. No.
	"Clean modules only with a damp cloth."	162796

Remote I/O

Remote I/O IS1+ Digital output module

For Zone 1 Ex i

9475/32-08-52 Art. No. 210655



LED Indicator lamp Ex i

Art. No.



LED indicator lamp for intrinsically safe circuits 8010/3-02, Ex i

237972

Labelling strips

Art. No.

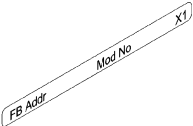

"FB Addr ... Mod No ..." for pluggable terminal, 26 pieces on the sheet

162788

DIN A4 sheet

Art. No.



For the label plate on I/O modules, 6 labels per sheet
Print IS Wizard, packaging unit = 20 sheets

162832

We reserve the right to make alterations to the technical data, dimensions, weights, designs and products available without notice. The illustrations cannot be considered binding.