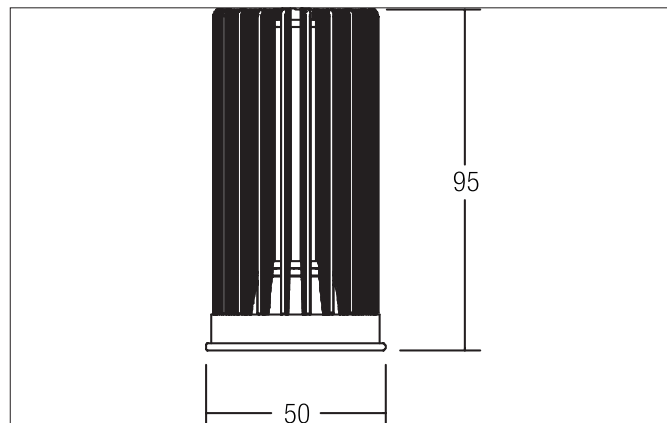

**LED reflector insert MR16, 12,5 W, SunLike, CRI > 97**

Artikel-Nr. 12983003

Licht.  
Für Generationen.**Tender**

LED reflector insert MR16, 12,5 W, SunLike, CRI > 97. Lamp holder: Plug&Play, Material: Aluminium / Plastic, Degree of protection: according to DIN EN 60529 IP20, Protection class: (EN 61140) III, Current: 350 mA, Power: 12.5W, Luminous flux: 920lm, Colour temperature: 3.000 K, Light colour : White, Beam angle: 38°, Control: Dimming depending on driver.

**Article data**

Artikel-Nr.	12983003
GTIN	4251433921653
Kurzbeschreibung	LED reflector insert MR16, 12,5 W, SunLike, CRI > 97
Material	Aluminium / Plastic
Outer diameter	50 mm
Installation depth	95 mm
Hight	95 mm
weight	0.125 kg

**Lighting technology**

Colour temperature	3000 K
Light colour	White
Luminous flux	920 lm
System efficiency	74 lm/W
Colour rendering	CRI > 97
Reflector	High-gloss
Beam angle	38 °
Light sharing	Symmetric









**LED reflector insert MR16, 12,5 W, SunLike, CRI > 97**

Artikel-Nr. 12983003

Licht.  
Für Generationen.

Packing data	
Gross weight	0.14 kg
Length of packaging	60 mm
Packaging width	10 mm
Packaging height	110 mm

Accessories	
	<p>Artikel-Nr.: 17613000            Kurzbeschreibung: LED converter 350 mA, on/off            Leistung: 1 - 15 W            Abmessung: 115 mm x 34 mm x 19 mm</p>
	<p>Artikel-Nr.: 17621020            Kurzbeschreibung: LED converter 350 mA, on/off            Leistung: 1 - 21 W            Abmessung: 128 mm x 50 mm x 13 mm</p>
	<p>Artikel-Nr.: 17664020            Kurzbeschreibung: LED converter 350 mA, trailing-edge phase dimmable            Leistung: 10,2 - 14 W            Abmessung: 125 mm x 51 mm x 20 mm</p>
	<p>Artikel-Nr.: 17643020            Kurzbeschreibung: LED converter 350 mA, trailing-edge phase dimmable            Leistung: 8,8 - 18 W            Abmessung: 110 mm x 52 mm x 22 mm</p>
	<p>Artikel-Nr.: 17657000            Kurzbeschreibung: LED converter 350 mA, 1-10 V dimmable (analog)            Leistung: 5,2 - 18 W            Abmessung: 110.5 mm x 52 mm x 22 mm</p>
	<p>Artikel-Nr.: 17683020            Kurzbeschreibung: LED converter 350 mA, DALI dimmable (digital)            Leistung: 3,5 - 17 W            Abmessung: 110.5 mm x 52 mm x 22 mm</p>
	<p>Artikel-Nr.: 17648020            Kurzbeschreibung: LED converter 350 mA, trailing-edge phase dimmable            Leistung: 0,7 - 17 W            Abmessung: 166 mm x 46 mm x 34 mm</p>
	<p>Artikel-Nr.: 17671020            Kurzbeschreibung: LED converter 350mA, ZigBee dimmable            Leistung: 3,5 - 18,5 W            Abmessung: 146.5 mm x 44 mm x 30 mm</p>
	<p>Artikel-Nr.: 17672020            Kurzbeschreibung: LED converter 350mA, Casambi dimmable            Leistung: 3,5 - 18 W            Abmessung: 146.5 mm x 44 mm x 30 mm</p>