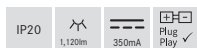
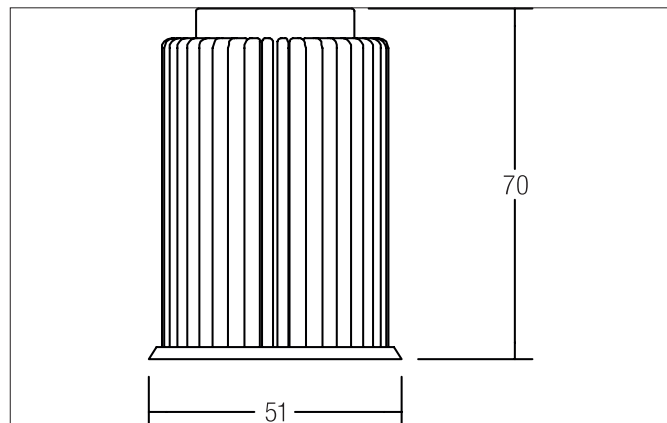

LED reflector insert MR16, 12 W

Artikel-Nr. 12953003

Licht.
Für Generationen.**Tender**

LED reflector insert MR16, 12 W, round. Lamp holder: Plug&Play, Material: Aluminium / Glass, Degree of protection: according to DIN EN 60529 IP20, Protection class: (EN 61140) III, Current: 350 mA, Power: 12W, Luminous flux: 1.120lm, Colour temperature: 2.700 K, Light colour : White, Beam angle: 38°, Control: Dimming depending on driver.

Article data

| | |
|------------------|---------------------------------|
| Artikel-Nr. | 12953003 |
| GTIN | 4250047793151 |
| Kurzbeschreibung | LED reflector insert MR16, 12 W |
| Material | Aluminium / Glass |
| Shape | Round |
| Outer diameter | 50 mm |
| Hight | 70 mm |
| weight | 0.143 kg |









Lighting technology

| | |
|--------------------|------------|
| Colour temperature | 2700 K |
| Light colour | White |
| Luminous flux | 1,120 lm |
| System efficiency | 93 lm/W |
| Colour rendering | CRI > 80 |
| Reflector | High-gloss |
| Beam angle | 38 ° |
| Light sharing | Symmetric |

LED reflector insert MR16, 12 W
 Artikel-Nr. 12953003

Licht.
 Für Generationen.

| Packing data | |
|---------------------|----------|
| Gross weight | 0.161 kg |
| Length of packaging | 60 mm |
| Packaging width | 60 mm |
| Packaging height | 83 mm |

| Accessories | |
|---|--|
|  | <p>Artikel-Nr.: 17613000 Kurzbeschreibung: LED converter 350 mA, on/off Leistung: 1 - 15 W Abmessung: 115 mm x 34 mm x 19 mm</p> |
|  | <p>Artikel-Nr.: 17621020 Kurzbeschreibung: LED converter 350 mA, on/off Leistung: 1 - 21 W Abmessung: 128 mm x 50 mm x 13 mm</p> |
|  | <p>Artikel-Nr.: 17664020 Kurzbeschreibung: LED converter 350 mA, trailing-edge phase dimmable Leistung: 10,2 - 14 W Abmessung: 125 mm x 51 mm x 20 mm</p> |
|  | <p>Artikel-Nr.: 17643020 Kurzbeschreibung: LED converter 350 mA, trailing-edge phase dimmable Leistung: 8,8 - 18 W Abmessung: 110 mm x 52 mm x 22 mm</p> |
|  | <p>Artikel-Nr.: 17657000 Kurzbeschreibung: LED converter 350 mA, 1-10 V dimmable (analog) Leistung: 5,2 - 18 W Abmessung: 110.5 mm x 52 mm x 22 mm</p> |
|  | <p>Artikel-Nr.: 17683020 Kurzbeschreibung: LED converter 350 mA, DALI dimmable (digital) Leistung: 3,5 - 17 W Abmessung: 110.5 mm x 52 mm x 22 mm</p> |
|  | <p>Artikel-Nr.: 17648020 Kurzbeschreibung: LED converter 350 mA, trailing-edge phase dimmable Leistung: 0,7 - 17 W Abmessung: 166 mm x 46 mm x 34 mm</p> |
|  | <p>Artikel-Nr.: 17671020 Kurzbeschreibung: LED converter 350mA, ZigBee dimmable Leistung: 3,5 - 18,5 W Abmessung: 146.5 mm x 44 mm x 30 mm</p> |
|  | <p>Artikel-Nr.: 17672020 Kurzbeschreibung: LED converter 350mA, Casambi dimmable Leistung: 3,5 - 18 W Abmessung: 146.5 mm x 44 mm x 30 mm</p> |