

JAMIE 301.940.35.2/DALI-EU



Beschreibung

- flexibler Stromschienenstrahler in kompakter Bauform mit zylinderförmigem Design
- Leuchte 350° drehbar und 90° schwenkbar über integrierten Gelenkarm
- hohe Wartungsfreundlichkeit
- keine UV- und Wärmestrahlung
- Wärmemanagement über Gehäuse
- Spiegelreflektor aus Aluminium mit präziser symmetrischer Abstrahlcharakteristik für optimale Lichtausbeute und Entblendung
- Gehäusezylinder aus Aluminium
- Schutzglas klar
- 3-Phasen-Stromschienenadapter DALI (Professional)
- Betriebsgerät (LED-Konverter DALI, dimmbar) integriert

Standardoptionen

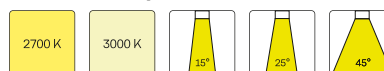

Sonderoptionen



Farbe	Artikelnummer	EAN
schwarz	658025	4043544669438
silber	658026	4043544669445
weiß	658027	4043544669452

Lichttechnik / Normen

Leuchtmittel	LED Spot / CRI 90 / 4000 K
EPREL Lichtquellen	851045
Lebensdauer	L90 B50 50.000 h L80 B50 100.000 h L80 B20 50.000 h
Systemleistung	16.0 W
Leuchten-Lichtstrom	1400 lm
Systemeffizienz	87.50 lm/W
Moduleffizienz	139.42 lm/W
UGR Klasse	≤19
Abstrahlwinkel	35°
Versorgungsspannung	220 - 240 V / 50 - 60 Hz
Schutzklasse	I
Schutzart	IP20

Abmessungen / Gewichte

Länge	125 mm
Breite	80 mm
Höhe	215 mm
Durchmesser Lichtkopf	80 mm
Nettogewicht	0.90 kg
Bruttogewicht	1.00 kg

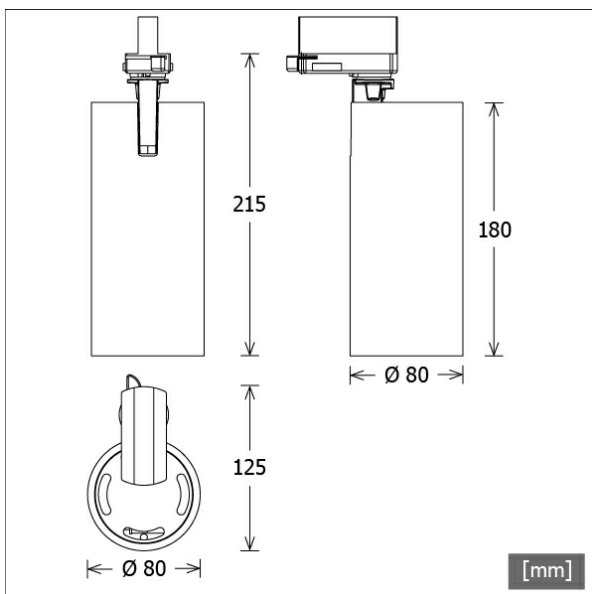

JAMIE 301.940.35.2/DALI-EU

Jamie 300 (1xLED 16W 940/4000K 1400lm 35 °)

C0/C180 cd / 1000 lm

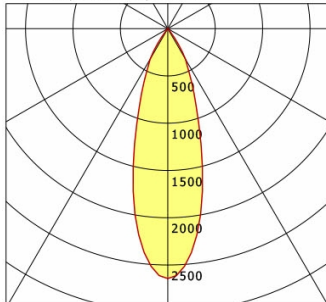

	C0	C90	C180	C270
0°	2643	2643	2643	2643
15°	1389	1389	1389	1389
30°	372	372	372	372
45°	14	14	14	14
60°	8	8	8	8
75°	5	5	5	5
90°	0	0	0	0

cd / 1000 lm

Offset [m] Cone width [m] Illuminance [lx]

Offset [m]	Cone width [m]	Illuminance [lx]
3.0	1.68	411.1
6.0	3.35	102.8
9.0	5.03	45.7
12.0	6.70	25.7
15.0	8.38	16.4

η	LED
Efficiency	88 lm/W
Direct/Indirect	↓ 100% / ↑ 0%
System Power	16 W
UGR	X=4H, Y=8H
Reflection factors	70/50/20
UGR C0/C180	17.8
UGR C90/C270	17.8
CIE Flux Codes	97 99 100 100 100
Ra/CRI	>90

LTS

Zubehör



EUB 10
Anbau-Stromschiene Professional mit Datenbus
(Länge: 1000 mm)



EUB 20
Anbau-Stromschiene Professional mit Datenbus
(Länge: 2000 mm)



EUB 21
Anbau-Stromschiene Professional mit Datenbus
(Länge: 3000 mm)



EUB 22
Anbau-Stromschiene Professional mit Datenbus
(Länge: 4000 mm)



EUEB 20
Einbau-Stromschiene Professional mit Datenbus
(Länge: 2000 mm)



EUEB 21
Einbau-Stromschiene Professional mit Datenbus
(Länge: 3000 mm)



EUEB 22
Einbau-Stromschiene Professional mit Datenbus
(Länge: 4000 mm)



LAB 60
3-Phasen-Einbau-Monopoint mit Busoption



LAB 60 A
3-Phasen-Anbau-Monopoint mit Busoption



ZBK 12
Blendklappe



ZBW 85
Wabenraster