

# JAMIE 301.927.45.2



## Beschreibung

- flexibler Stromschienenstrahler in kompakter Bauform mit zylinderförmigem Design
- Leuchte 350° drehbar und 90° schwenkbar über integrierten Gelenkarm
- hohe Wartungsfreundlichkeit
- keine UV- und Wärmestrahlung
- Wärmemanagement über Gehäuse
- Spiegelreflektor aus Aluminium mit präziser symmetrischer Abstrahlcharakteristik für optimale Lichtausbeute und Entblendung
- Gehäusezylinder aus Aluminium
- Schutzglas klar
- 3-Phasen-Stromschienenadapter
- Betriebsgerät (LED-Konverter) integriert

## Standardoptionen



Farbe	Artikelnummer	EAN
schwarz	657956	4043544668745
silber	657957	4043544668752
weiß	657958	4043544668769

## Sonderoptionen



## Lichttechnik / Normen

Leuchtmittel	LED Spot / CRI 90 / 2700 K
EPREL Lichtquellen	848120
Lebensdauer	L90 B50 50.000 h L80 B50 100.000 h L80 B20 50.000 h
Systemleistung	16.0 W
Leuchten-Lichtstrom	1230 lm
Systemeffizienz	76.87 lm/W
Moduleffizienz	127.18 lm/W
UGR Klasse	≤19
Abstrahlwinkel	45°
Versorgungsspannung	220 - 240 V / 50 - 60 Hz
Schutzklasse	I
Schutzart	IP20

## Abmessungen / Gewichte

Länge	125 mm
Breite	80 mm
Höhe	215 mm
Durchmesser Lichtkopf	80 mm
Nettogewicht	0.84 kg
Bruttogewicht	0.94 kg

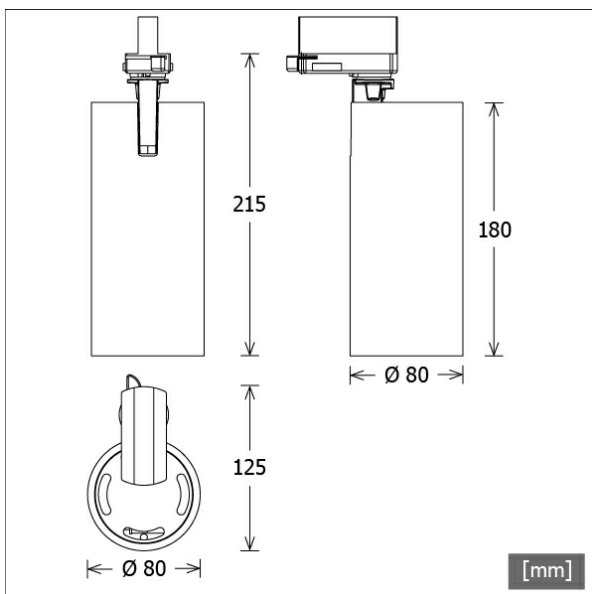

# JAMIE 301.927.45.2

Jamie 300 (1xLED 16W 927/2700K 1230lm 45 °)

— C0/C180 cd / 1000 lm

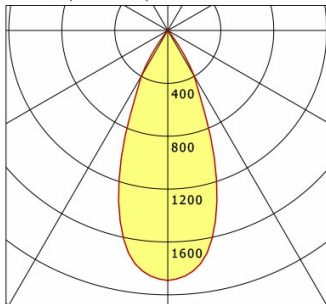

	C0	C90	C180	C270
0°	1892	1892	1892	1892
15°	1418	1418	1418	1418
30°	401	401	401	401
45°	16	16	16	16
60°	8	8	8	8
75°	6	6	6	6
90°	0	0	0	0
cd / 1000 lm				

Offset [m]	Cone width [m]	Illuminance [lx]
3.0	2.30	258.5
6.0	4.60	64.6
9.0	6.90	28.7
12.0	9.20	16.2
15.0	11.50	10.3

<b>η</b>	LED
Efficiency	77 lm/W
Direct/Indirect	↓ 100% / ↑ 0%
System Power	16 W
<b>UGR</b>	X=4H, Y=8H
Reflection factors	70/50/20
UGR C0/C180	17.9
UGR C90/C270	17.9
CIE Flux Codes	97 98 100 100 100
Ra/CRI	>90

LTS

## Zubehör



**EU 10**  
Anbau-Stromschiene Professional  
(Länge: 1000 mm)



**EU 20**  
Anbau-Stromschiene Professional  
(Länge: 2000 mm)



**EU 21**  
Anbau-Stromschiene Professional  
(Länge: 3000 mm)



**EU 22**  
Anbau-Stromschiene Professional  
(Länge: 4000 mm)



**EUE 20**  
Einbau-Stromschiene Professional  
(Länge: 2000 mm)



**EUE 21**  
Einbau-Stromschiene Professional  
(Länge: 3000 mm)



**EUE 22**  
Einbau-Stromschiene Professional  
(Länge: 4000 mm)



**LAB 60**  
3-Phasen-Einbau-Monopoint mit Busoption



**LAB 60 A**  
3-Phasen-Anbau-Monopoint mit Busoption



**ST-A 10/9000A-1-ST**  
Anbau-Stromschiene ONETrack Advance mit Datenbus  
(Länge: 1000 mm)



**ST-A 20/9000A-2-ST**  
Anbau-Stromschiene ONETrack Advance mit Datenbus  
(Länge: 2000 mm)



**ST-A 30/9000A-3-ST**  
Anbau-Stromschiene ONETrack Advance mit Datenbus  
(Länge: 3000 mm)

# JAMIE 301.927.45.2

## Zubehör



**ST-A 40/9000A-4-ST**  
Anbau-Stromschiene ONETrack Advance mit Datenbus  
(Länge: 4000 mm)



**ST-A MONO/9000-BPU-D**  
3-Phasen-Anbau-Monopoint mit Busoption



**ST-E 10/9000-1-R**  
Einbau-Stromschiene ONETrack mit Datenbus  
(Länge: 1000 mm)



**ST-E 20/9000-2-R**  
Einbau-Stromschiene ONETrack mit Datenbus  
(Länge: 2000 mm)



**ST-E 30/9000-3-R**  
Einbau-Stromschiene ONETrack mit Datenbus  
(Länge: 3000 mm)



**ST-E 40/9000-4-R**  
Einbau-Stromschiene ONETrack mit Datenbus  
(Länge: 4000 mm)



**ST-E MONO/9000-BPU-D**  
3-Phasen-Einbau-Monopoint mit Busoption



**ZBK 12**  
Blendklappe



**ZBW 85**  
Wabenraster