

# JAMIE 302.930.25.2



## Beschreibung

- flexibler Stromschienenstrahler in kompakter Bauform mit zylinderförmigem Design
- Leuchte 350° drehbar und 90° schwenkbar über integrierten Gelenkarm
- hohe Wartungsfreundlichkeit
- keine UV- und Wärmestrahlung
- Wärmemanagement über Gehäuse
- Spiegelreflektor aus Aluminium mit präziser symmetrischer Abstrahlcharakteristik für optimale Lichtausbeute und Entblendung
- Gehäusezylinder aus Aluminium
- Schutzglas klar
- 3-Phasen-Stromschienenadapter
- Betriebsgerät (LED-Konverter) integriert

## Standardoptionen



Farbe	Artikelnummer	EAN
schwarz	658064	4043544669827
silber	658065	4043544669834
weiß	658066	4043544669841

## Sonderoptionen



## Lichttechnik / Normen

Leuchtmittel	LED Spot / CRI 90 / 3000 K
EPREL Lichtquellen	851296
Lebensdauer	L90 B50 50.000 h L80 B50 100.000 h L80 B20 50.000 h
Systemleistung	24.6 W
Leuchten-Lichtstrom	2360 lm
Systemeffizienz	95.93 lm/W
Moduleffizienz	134.21 lm/W
UGR Klasse	≤22
Abstrahlwinkel	25°
Versorgungsspannung	220 - 240 V / 50 - 60 Hz
Schutzklasse	I
Schutzart	IP20

## Abmessungen / Gewichte

Länge	125 mm
Breite	80 mm
Höhe	215 mm
Durchmesser Lichtkopf	80 mm
Nettogewicht	0.84 kg
Bruttogewicht	0.94 kg

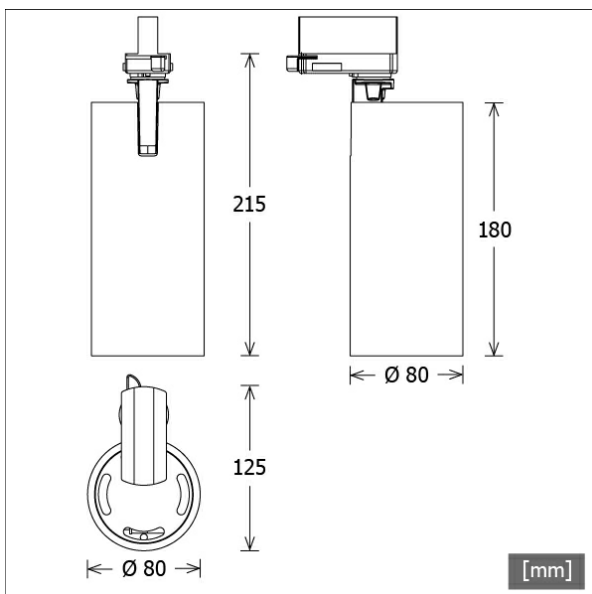

# JAMIE 302.930.25.2

Jamie 300 (1xLED 25W 930/3000K 2360lm 25 °)

— C0/C180 cd / 1000 lm

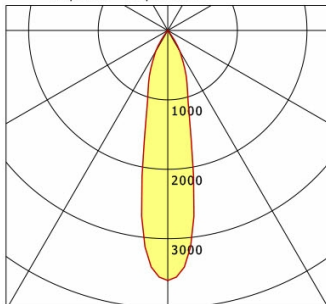

	C0	C90	C180	C270
0°	3602	3602	3602	3602
15°	1156	1156	1156	1156
30°	352	352	352	352
45°	18	18	18	18
60°	9	9	9	9
75°	5	5	5	5
90°	0	0	0	0
cd / 1000 lm				

Offset [m] Cone width [m] Illuminance [lx]

Offset [m]	Cone width [m]	Illuminance [lx]
3.0	1.21	944.6
6.0	2.41	236.2
9.0	3.62	105.0
12.0	4.82	59.0
15.0	6.03	37.8

<b>η</b>	LED
Efficiency	95 lm/W
Direct/Indirect	↓ 100% / ↑ 0%
System Power	25 W
<b>UGR</b>	X=4H, Y=8H
Reflection factors	70/50/20
UGR C0/C180	19.6
UGR C90/C270	19.6
CIE Flux Codes	96 98 100 100 100
Ra/CRI	>90

LTS

## Zubehör



**EU 10**  
Anbau-Stromschiene Professional  
(Länge: 1000 mm)



**EU 20**  
Anbau-Stromschiene Professional  
(Länge: 2000 mm)



**EU 21**  
Anbau-Stromschiene Professional  
(Länge: 3000 mm)



**EU 22**  
Anbau-Stromschiene Professional  
(Länge: 4000 mm)



**EUE 20**  
Einbau-Stromschiene Professional  
(Länge: 2000 mm)



**EUE 21**  
Einbau-Stromschiene Professional  
(Länge: 3000 mm)



**EUE 22**  
Einbau-Stromschiene Professional  
(Länge: 4000 mm)



**LAB 60**  
3-Phasen-Einbau-Monopoint mit Busoption



**LAB 60 A**  
3-Phasen-Anbau-Monopoint mit Busoption



**ST-A 10/9000A-1-ST**  
Anbau-Stromschiene ONETrack Advance mit Datenbus  
(Länge: 1000 mm)



**ST-A 20/9000A-2-ST**  
Anbau-Stromschiene ONETrack Advance mit Datenbus  
(Länge: 2000 mm)



**ST-A 30/9000A-3-ST**  
Anbau-Stromschiene ONETrack Advance mit Datenbus  
(Länge: 3000 mm)

# JAMIE 302.930.25.2

## Zubehör



**ST-A 40/9000A-4-ST**  
Anbau-Stromschiene ONETrack Advance mit Datenbus  
(Länge: 4000 mm)



**ST-A MONO/9000-BPU-D**  
3-Phasen-Anbau-Monopoint mit Busoption



**ST-E 10/9000-1-R**  
Einbau-Stromschiene ONETrack mit Datenbus  
(Länge: 1000 mm)



**ST-E 20/9000-2-R**  
Einbau-Stromschiene ONETrack mit Datenbus  
(Länge: 2000 mm)



**ST-E 30/9000-3-R**  
Einbau-Stromschiene ONETrack mit Datenbus  
(Länge: 3000 mm)



**ST-E 40/9000-4-R**  
Einbau-Stromschiene ONETrack mit Datenbus  
(Länge: 4000 mm)



**ST-E MONO/9000-BPU-D**  
3-Phasen-Einbau-Monopoint mit Busoption



**ZBK 12**  
Blendklappe



**ZBW 85**  
Wabenraster