



- Large selection of different actuators
- Versions as an NC with positive opening, NO or disconnect terminal

WebCode **8082A**



R. STAHL Series 8082 contact elements have an NO contact and a positive opening operation NC contact, made from silver-nickel or gold-plated. They can be easily combined with contact blocks and enable customised installations, also due to the large selection of the various actuators.

Technical Data

Explosion Protection

Application range (zones)	1 2
IECEX gas certificate	IECEX PTB 06.0011U
IECEX gas explosion protection	Ex db eb IIC T6/T4 Gb
IECEX firedamp certificate	IECEX PTB 06.0011U
IECEX firedamp protection	Ex db eb I Mb
ATEX gas certificate	PTB 00 ATEX 1031 U
ATEX gas explosion protection	Ex II 2 G Ex db eb IIC T6/T4 Gb
ATEX firedamp certificate	PTB 00 ATEX 1031 U
ATEX firedamp protection	Ex I M2 Ex db eb I Mb
UL gas certificate	E182378V1S1
Inmetro gas certificate	ULBR130645U
Certificates	ATEX (PTB), Brazil (ULB), Canada / USA (UL), EAC (ENDCE), IECEX (PTB), Korea (KTL), SIL (exida)
Notes	Product label may vary. Series devices have certification according to ATEX, IECEX and NEC.

Functional Safety

SIL-capable	without actuator or with actuators 8602/3-006, 8602/3-009, 8602/3-010, 8602/3-012
-------------	---

Electrical Data

Rated operational voltage max.	550 V
Rated operational voltage min.	24 V
Rated operational voltage AC UL	600 – 600 V
Rated operational current	100 mA / 10 A
Rated operational current UL	600 A
Electrical service life	10 ⁶ operations
Mechanical service life	10 ⁶ operations

Electrical Data

switching capacity AC-12	250 V / 10 A 400 V / 7,5 A 550 V / 5 A
switching capacity AC-15	110 V / 10 A 250 V / 6 A 400 V / 4 A
switching capacity DC-13	60 V / 6 A
Pot. conm. DC-13 2 KE.i.Rei.	230 V / 1 A 110 V / 2.5 A

Ambient Conditions

Ambient temperature	-60 °C ... +70 °C (T6) -60 °C ... +55 °C (T4)
Operating temperature	-60 °C ... +100 °C

Mechanical Data

Degree of protection IP (IEC 60529)	IP20
Enclosure material	Polyamide
Contact material	Silver-nickel
Silicone-free	Yes
Connection cross-section solid	0.75 – 2.5 mm ²
Connection cross-section finely stranded	0.75 – 2.5 mm ²
Connection cross section finely stranded with core end sleeve	0.75 – 2.5 mm ²
Number of NOs	1
Contacts	1 NO
Packaging unit	1
Weight	0.03 kg
Weight	0.066 lb

Mounting / Installation

Tightening torque	1.2 Nm
Tightening torque lbf in	10.62 lbf in
Connection type	Screw terminal

Dimensional Drawings (All Dimensions in mm [inches]) – Subject to Alterations

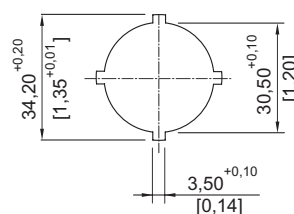
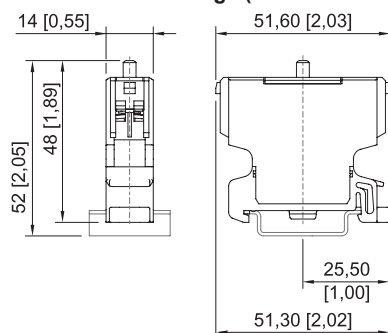

Contact element, single

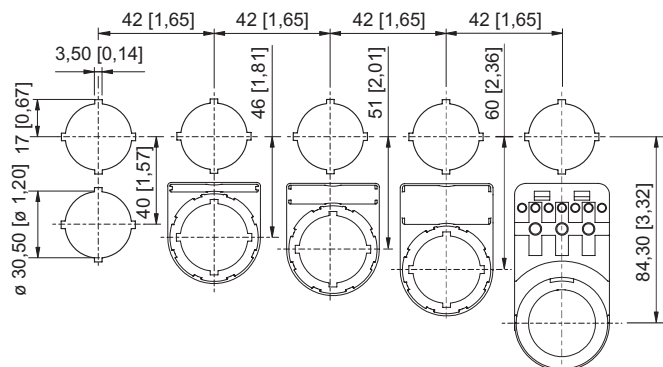

Standard cut-out with / without front label

Accessories

Pushbutton

		Art. No.
	Ø 39 mm Black Designation plate: black, blank label without text Silicone-free: Yes	223691
	Ø 39 mm Black Designation plate: black, blank label without text Silicone-free: No	223692

Mushroom pushbutton, black

		Art. No.
	Ø 39 mm Black Designation plate: black, blank label without text Silicone-free: Yes	244563
	Ø 39 mm Black Designation plate: black, blank label without text Silicone-free: No	244564

Mushroom pushbutton, red

		Art. No.
	Ø 39 mm Red/black Designation plate: red, blank label without text Silicone-free: Yes	244565
	Ø 39 mm Red/black Designation plate: red, blank label without text Silicone-free: No	244566

Mushroom stay-put button with key

		Art. No.
	Ø 39 mm Red/black Closing: MS1 Silicone-free: Yes	223695
	Ø 39 mm Red/black Closing: MS1 Silicone-free: No	223696

Key-operated switch actuator

		Art. No.
	Ø 39 mm Black Closing: MS1 Number of switching positions: 2 Switching function: Latching / Latching Silicone-free: No	244574

Control Devices

Contact element for mounting rail mounting NO

Ex e

8082/1-2-00 Art. No. 132640



	Ø 39 mm Black Closing: MS1 Number of switching positions: 3 Switching function: Latching / Latching / Latching Silicone-free: No	244633
--	---	--------

Mushroom stay-put button with EM-STOP key

Art. No.

	Ø 39 mm yellow/red Designation plate: with yellow backing plate Closing: MS1 Silicone-free: Yes	223693
	Ø 39 mm yellow/red Designation plate: with yellow backing plate Closing: MS1 Silicone-free: No	223694

Mushroom stay-put button EM-STOP

Art. No.

	Ø 39 mm yellow/red Designation plate: with yellow backing plate Silicone-free: Yes	223697
	Ø 39 mm yellow/red Designation plate: with yellow backing plate Silicone-free: No	223698

Mushroom stay-put button, black

Art. No.

	Ø 39 mm Black Silicone-free: Yes	223699
	Ø 39 mm Black Silicone-free: No	223700

Mushroom pushbutton 55 mm red

Art. No.

	Ø 55 mm black/red Designation plate: red, blank label without text Silicone-free: Yes	244634
	Ø 55 mm black/red Designation plate: red, blank label without text Silicone-free: No	244635

Mushroom stay-put button 55 mm EM-STOP

Art. No.

	Ø 55 mm yellow/red Designation plate: with yellow backing plate Silicone-free: Yes	244636
	Ø 55 mm yellow/red Designation plate: with yellow backing plate Silicone-free: No	244637

Twin pushbutton

Art. No.

	Black Impact strength: 7 J	244638
	Black Impact strength: 7 J	244639

Control Devices

Contact element for mounting rail mounting NO

Ex e

8082/1-2-00 Art. No. 132640





Mushroom pushbutton 55 mm black

Art. No.

	<p>Ø 55 mm Black Designation plate: black, blank label without textSilicone-free: Yes</p>	244642
	<p>Ø 55 mm Black Designation plate: black, blank label without textSilicone-free: No</p>	244643

Small rotary actuator, not lockable

Art. No.

	<p>Ø 39 mm Black Designation plate: 0/OFF - I/ON Number of switching positions: 2 Lockable in: Not padlockable Switching function: Latching / LatchingSilicone-free: Yes</p>	244646
	<p>Ø 39 mm Black Designation plate: 0/OFF - I/ON Number of switching positions: 2 Lockable in: Not padlockable Switching function: Latching / LatchingSilicone-free: No</p>	244647
	<p>Ø 39 mm Black Designation plate: I - 0 - II Number of switching positions: 3 Lockable in: Not padlockable Switching function: Latching / Latching / Latching Silicone-free: Yes</p>	244648
	<p>Ø 39 mm Black Designation plate: I - 0 - II Number of switching positions: 3 Lockable in: Not padlockable Switching function: Latching / Latching / Latching Silicone-free: No</p>	244649

Small rotary actuator, lockable

Art. No.

	<p>Ø 39 mm Black Designation plate: 0/OFF - I/ON Number of switching positions: 2 Lockable in: One pos. with one lock Switching function: Latching / LatchingImpact strength: 7 J</p>	244650
	<p>Ø 39 mm Black Designation plate: 0/OFF - I/ON Number of switching positions: 2 Lockable in: One pos. with one lock Switching function: Latching / LatchingImpact strength: 7 J</p>	244651

Control Devices

Contact element for mounting rail mounting NO

Ex e

8082/1-2-00 Art. No. 132640





	Ø 39 mm Black Designation plate: I - 0 - II Number of switching positions: 3 Lockable in: One pos. with one lock Switching function: Latching / Latching / Latching Impact strength: 7 J	244652
	Ø 39 mm Black Designation plate: I - 0 - II Number of switching positions: 3 Lockable in: One pos. with one lock Switching function: Latching / Latching / Latching Impact strength: 7 J	244653

Illuminated pushbutton (spring return)

		Art. No.
	Diameter 39.0 mm All colours Silicone-free: Yes	244654
	Diameter 39.0 mm All colours Silicone-free: No	244655

Spare Parts

Mushroom stay-put button with key

		Art. No.
	Ø 39 mm Red/black Closing: MS2 Silicone-free: Yes	270409
	Ø 39 mm Red/black Closing: MS2 Silicone-free: No	270412
	Ø 39 mm Red/black Closing: MS3 Silicone-free: Yes	270410
	Ø 39 mm Red/black Closing: MS3 Silicone-free: No	270413
	Ø 39 mm Red/black Closing: MS4 Silicone-free: Yes	270411
	Silicone-free Ø 39 mm Red/black Closing: MS4 Silicone-free: No	270414

Control Devices

Contact element for mounting rail mounting NO

Ex e

8082/1-2-00 Art. No. 132640



Key-operated switch actuator

Art. No.

	Ø 39 mm Black Closing: MS1 Number of switching positions: 2 Switching function: Latching / Latching Silicone-free: Yes	244573
	Ø 39 mm Black Closing: MS2 Number of switching positions: 2 Switching function: Latching / Latching Silicone-free: Yes	272935
	Ø 39 mm Black Closing: MS3 Number of switching positions: 2 Switching function: Latching / Latching Silicone-free: Yes	274089
	Ø 39 mm Black Closing: MS4 Number of switching positions: 2 Switching function: Latching / Latching Silicone-free: Yes	272936
	Ø 39 mm Black Closing: MS1 Number of switching positions: 3 Switching function: Latching / Latching / Latching Silicone-free: N/A	244632
	Ø 39 mm Black Closing: MS2 Number of switching positions: 3 Switching function: Latching / Latching / Latching Silicone-free: Yes	274090
	Ø 39 mm Black Closing: MS3 Number of switching positions: 3 Switching function: Latching / Latching / Latching Silicone-free: Yes	274091
	Ø 39 mm Black Closing: MS4 Number of switching positions: 3 Switching function: Latching / Latching / Latching Silicone-free: Yes	274092

Control Devices

Contact element for mounting rail mounting NO

Ex e

8082/1-2-00 Art. No. 132640



	Ø 39 mm Black Closing: MS2 Number of switching positions: 2 Switching function: Latching / LatchingSilicone-free: No	270418
	Ø 39 mm Black Closing: MS3 Number of switching positions: 2 Switching function: Latching / LatchingSilicone-free: No	270419
	Ø 39 mm Black Closing: MS4 Number of switching positions: 2 Switching function: Latching / LatchingSilicone-free: No	270420
	Ø 39 mm Black Closing: MS2 Number of switching positions: 3 Switching function: Latching / Latching / LatchingSilicone-free: No	270421
	Ø 39 mm Black Closing: MS3 Number of switching positions: 3 Switching function: Latching / Latching / Latching Silicone-free No	270422
	Ø 39 mm Black Closing: MS4 Number of switching positions: 3 Switching function: Latching / Latching / Latching Silicone-free: No	270423

Mushroom stay-put button with EM-STOP key

Art. No.

	Ø 39 mm yellow/red Designation plate: with yellow backing plate Closing: MS2Silicone-free: Yes	274099
	Ø 39 mm yellow/red Designation plate: with yellow backing plate Closing: MS2Silicone-free: No	270415
	Ø 39 mm yellow/red Designation plate: with yellow backing plate Closing: MS3Silicone-free: Yes	274100

Art. No.

	Ø 39 mm yellow/red Designation plate: with yellow backing plate Closing: MS3Silicone-free: No	270416
--	--	--------

Control Devices

Contact element for mounting rail mounting NO

Ex e

8082/1-2-00 Art. No. 132640



Mushroom stay-put button with EM-STOP key

Art. No.

	Ø 39 mm yellow/red Designation plate: with yellow backing plate Closing: MS4Silicone-free: Yes	274101
	Ø 39 mm yellow/red Designation plate: with yellow backing plate Closing: MS4Silicone-free: No	270417

Adaptor for front installation

Art. No.

	8602/3 Front installation for indicator lamp series 8010/6 and contact element series 8082/3	227038
--	--	--------

Holder for front installation

Art. No.

	8602/3 holder for cable duct	248673
---	------------------------------	--------

We reserve the right to make alterations to the technical data, dimensions, weights, designs and products available without notice. The illustrations cannot be considered binding.